



Get Organised™



# 2023/24 CATALOGUE

[www.tengtools.com](http://www.tengtools.com)



# WELCOME TO OUR WORLD

When you choose TengTools you immediately stand out from the crowd as an individual who is intent on achieving their goals.

TengTools offer a modular tool system that is built to last. Build your ultimate tool kit with our large selection of storage and tool sets enabling customised tool solutions for any kind of industry or profession.

Get Organised™ with a tool control system designed to boost efficiency and save time.



















# CONTENTS

TT  
SERIES

FOAM  
SERIES

<b>TT Series</b>	<b>10</b>
Tool Kits	10
Tool Trays	50
<b>FOAM Series</b>	<b>96</b>
Tool Kits	96
Tool Trays	116
<hr/>	
Other Tool Sets	152
Tool Storage	162
Socket Sets	198
Sockets & Accessories	228
Torque Tools	276
Spanners & Wrenches	290
Screwdrivers	318
Bits & Drivers	334
Hex & Tx Keys	356
Pliers	374
Insulated Tools	394
Cutting Tools	404
Measuring Tools	417
Auto Tools	423
Service Tools	435
Air Tools	465
Tengtools Collection	476
Index	481

Other Tool Sets	
Tool Storage	
Socket Sets	
Sockets & Accessories	
Torque Tools	
Spanners & Wrenches	
Screwdrivers	
Bits & Drivers	
Hex & Tx Keys	
Pliers	
Insulated Tools	
Cutting Tools	
Measuring Tools	
Auto Tools	
Service Tools	
Air Tools	
Tengtools Collection	

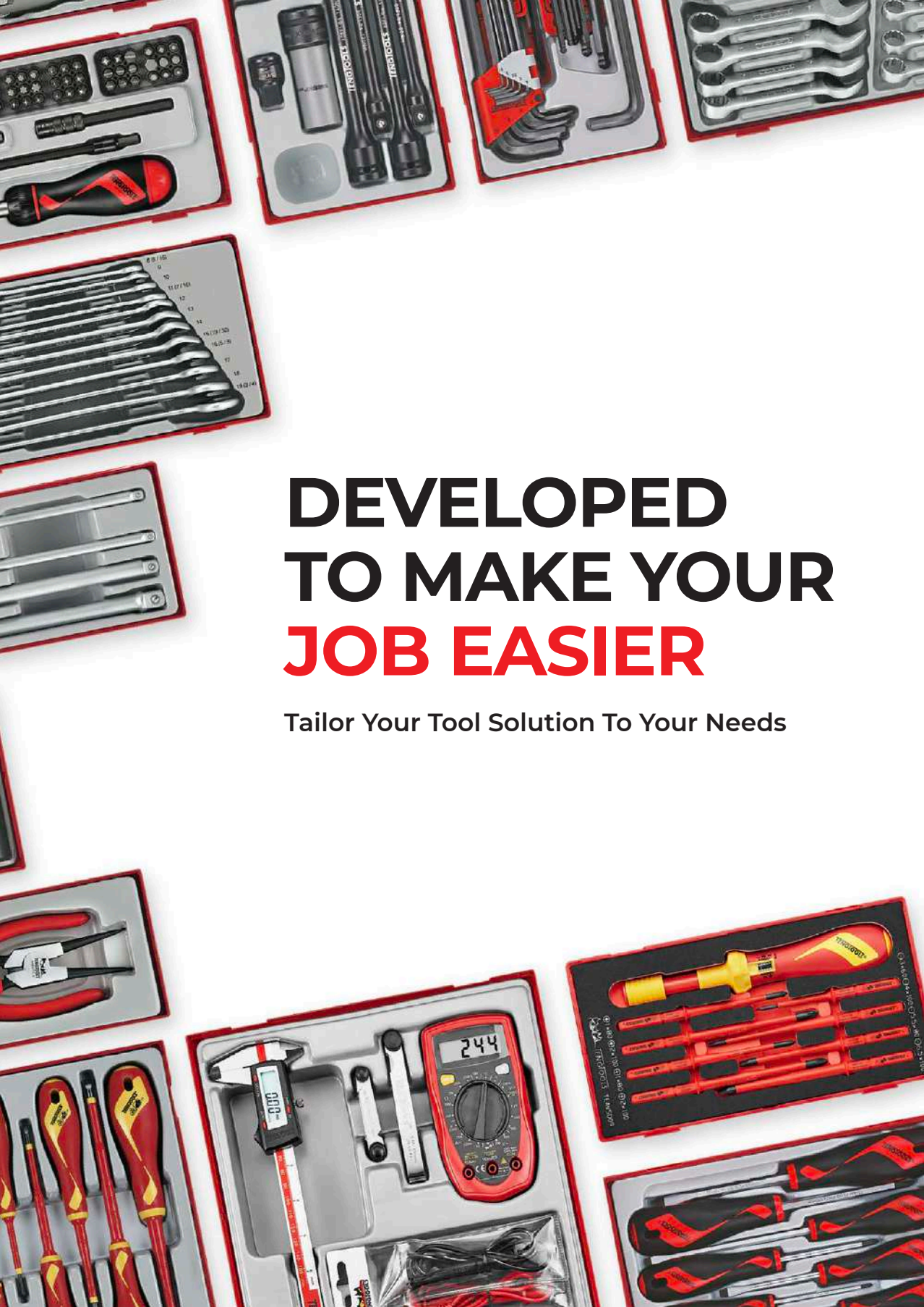

# DEVELOPED TO MAKE YOUR JOB EASIER

Tailor Your Tool Solution To Your Needs



TengTools offer a modular tool system that is built to last.

Build your ultimate tool kit with our large selection of storage and tool sets enabling customised tool solutions for any kind of industry or profession.

Don't waste space and money on tools you don't need. Buy the exact tools you require and if you need more in the future, just add new sets that fit seamlessly into your storage solution.

When you purchase TengTools you are guaranteed the highest quality. If a tool is worn out or if you happen to lose a piece, individual tools can be easily purchased as replacements.

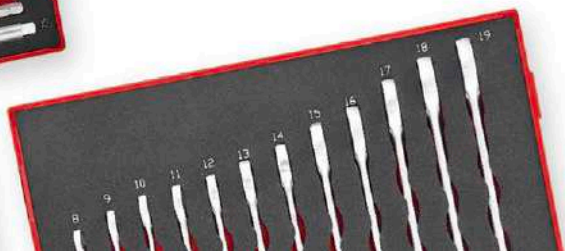

# GET ORGANISED™ FOR A BETTER WORKFLOW

There are several benefits to a well-organised hand tool solution:



**Time Saving:** An organised tool storage system can help you save time by reducing the time you spend searching for tools. When you have a designated spot for every tool, you can quickly locate the one you need.



**Increased productivity:** An organised workspace can help you work more efficiently and effectively. When you have a clear idea of where each tool is located, you can work faster, and the time you save can be used to complete more tasks.



**Improved safety:** A disorganised tool storage system can lead to accidents, such as tripping or falling, and injuries caused by misplaced tools. An organised system, on the other hand, reduces the chances of accidents and ensures that each tool is in its designated place, making it less likely to be left lying around where it could cause harm.



**Cost-effective:** An organised tool storage system can help you avoid buying tools you already have or replacing lost ones, saving you money in the long run.



**Better tool longevity:** When tools are stored properly, they are less likely to suffer damage from being knocked around or exposed to moisture or extreme temperatures. This means that they will last longer and perform better.



**Sustainability:** When you Get Organised™ with our long-lasting tools, you minimize the need to purchase replacements. That is sustainability in a nutshell.





# QUALITY IS EVERYTHING

Strong materials and experienced tool makers guarantee a consistent premium quality. The lifetime guarantee offered with our tools means you can rest assured they will not let you down.

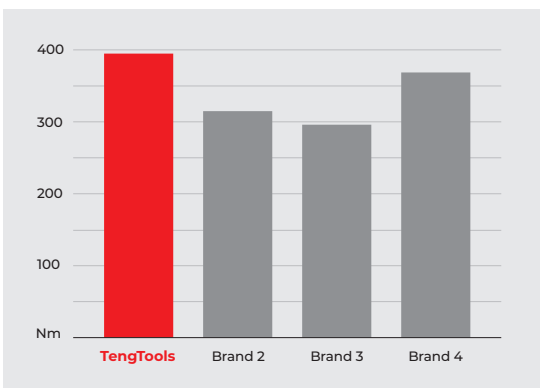

Adjustable wrench Comparison test. May 14, 2020. Torque breaking point (Nm).  
ISO 6787:2018.

## Proven to be better.

Independent tests have shown that our tools not only exceed the international quality standards – they are best in class. TengTools was positioned first or second in all of the eight product categories tested.

# LIFETIME GUARANTEE

All our tools meet – or exceed – the demands in ISO, DIN and other international standards. As an extra security for you, our tools are offered with a guarantee against material and manufacturing defects during the normal lifetime of the product in question. Defective products covered by the guarantee will be repaired or replaced.



\* Defects or performance issues caused by accidents, not approved modifications, misuse, normal wear & tear or lack of proper care are excluded.

A guarantee claim requires the submission or shipment of the complete product to the retailer or distributor along with a receipt or invoice validating the purchase date and the product designation.

Returned products are first managed by the distributor network, entrusted with applying TengTools' warranty and replacing items on stock. Replacement or repair of the product will be carried out as quickly as possible.

# STREAMLINE YOUR WORKFLOW

## Tailor your tool solution to your needs

Build your ultimate tool kit with our large selection of storage solutions and tool sets. Don't waste money on tools you don't need. When you can purchase the exact tools you require you save money and maximise space in your tool storage solution.

## How to get started

- Evaluate what type of storage solution you require
- A tip is to buy a slightly larger storage than what you currently need so your tool kit can grow with you
- Decide if you need tool sets in the premium feel Foam Series or in the space saving TT Series.
- Choose the exact tools that you need in a combination that fits into your chosen storage solution
- Our system is expandable and you can add new tool sets to your kit as new needs arise. You can also buy individual tools
- Our Tool Control System is modular so all tool sets can be transferred between different storage solutions. You can easily take a tool set from your workshop stack to your portable service case



Get Organised™



# TT SERIES TOOL KITS

## Better tools bring better results

Each tool kit has been compiled with the help of technicians from various trades and are available in many shapes and sizes. From full stacks to roller cabinets, and top boxes to portable solutions, there is a kit to fit your exact needs



### TT SERIES

---



**Space-saving:** The TT Series allows you to fit more tools in each drawer.



**Durability:** TT Series tool trays are made from a durable recyclable plastic that can withstand heavy use and are resistant to wear and tear.



**Easy to clean:** TT Series tool trays can be easily wiped clean with a damp cloth, making them simple to maintain and keep clean.



**Lightweight:** TT Series tool trays are lightweight, making the toolkit easier to move around and transport as required.



**Corrosion-resistant:** TT Series tool trays are resistant to corrosion, making them ideal for use in humid or damp environments.

Get Organised™



TT SERIES

TOOL KITS

MODULAR TOOL CONTROL SYSTEM

TT Series | Tool Kits

TT SERIES



# MONSTER™

## 53" PRO MONSTER TT TOOL KIT 1185 PIECES

- A complete tool kit covering the requirements of most users
- All the tools are laid out in individual tool modules using the TengTools Tool Control system
- Easy to see if any tools have been mislaid or lost helping to prevent leaving them with the work piece
- Supplied in a red TengTools 53" 19 drawer stack system with 10 drawer top box and the 9 drawer roller cabinet

- 19 Drawer**
- 53" Wide Cabinet**
- Heavy Gauge Steel**
- 5-Step Rust Protection**
- 6" Castor Wheels with Brakes**
- 3 Step Ball Bearing Slides**
- 1185 Pieces**
- 318.5 kg**
- Comfort Grip Handle**
- Combination Lock**



Drawer 1/10



Drawer 2/10



Drawer 3/10



Drawer 4/10



Drawer 5/10



Drawer 6/10



Drawer 7/10



Drawer 8/10



Drawer 9/10



Drawer 10/10



Drawer 1/9

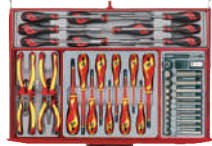

Drawer 2/9



Drawer 3/9



Drawer 4/9



Drawer 5/9



Drawer 6/9



Drawer 7/9



Drawer 8/9

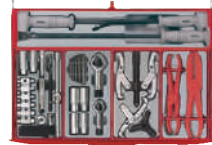

Drawer 9/9

Drawer	Item ID	Description
Storage	TC810N	53" PRO Top Box 10 Drawers Red
	TCW809N	53" PRO Cabinet 9 Drawers Red
1/10	TTD914N	Screwdriver Set Mixed TT2 14 Pieces
1/10	TTMD74	Ratcheting Screwdriver Bit Set TT1 74 Pieces
1/10	TTMD12D	Screwdriver Blade Set Mixed TT1 12 Pieces
1/10	TTX918N	Screwdriver Set Flat & PH TTX4 8 Pieces
2/10	TTD912TXN	Screwdriver Set TX TT2 12 Pieces
2/10	TTM116	Mini Pliers & Screwdriver Set TT1 16 Pieces
2/10	TT01	Storage Tray TT1 7 Compartments
2/10	TTXMDTN	Power Through Screwdriver Set TTX4 5 Pieces
3/10	TT1435	1/4" Socket Set 6 pt TT1 35 Pieces
3/10	TT3819	3/8" Socket Set 6 pt TT1 19 Pieces
3/10	TT1205	1/2" Ratchet & Accessories Set TT1 5 Pieces
3/10	TT1217	1/2" Socket Set 12 pt TT1 17 Pieces
3/10	TTXEXT13	Extension Bars Set TTX4 13 Pieces
4/10	TTAF32	1/4" & 3/8" Socket Set AF 6 pt TT1 32 Pieces
4/10	TT1215AF	1/2" Socket Set 12 pt AF TT1 15 Pieces
4/10	TT1211	1/2" Socket Set 12 pt TT1 11 Pieces
4/10	TT3816	3/8" Socket Set 6 pt TT1 16 Pieces
4/10	TTX00	Storage Tray TTX4 1 Compartment
5/10	TTHEX7	T-Handle Ball Point Hex Key Set TT1 7 Pieces
5/10	TTHEX7AF	T-Handle Hex Key Set AF TT1 7 Pieces
5/10	TTHT28	Ball Point Hex & TX Key Set TT1 28 Pieces
5/10	TTTX7	T-Handle TX/TPX Key Set TT1 7 Pieces
5/10	TTX03	Storage Tray TTX4 8 Compartments
6/10	TTD441-T	Plier Set TPR Grip TT2 8 Pieces
6/10	TT474-7	Circlip Plier Set 19-60 mm TT1 4 Pieces
6/10	TT00	Storage Tray With Tool Holder TT1
6/10	TTX474-9	Circlip Plier Set 40-100 mm TTX4 4 Pieces
7/10	TTTM03	Inspection Set TT1 3 Pieces
7/10	TTBM	Measuring Tool Set TT1 4 Pieces
7/10	TTSR04	Scraper Set TT1 4 Pieces
7/10	TTNF12	Needle File Set TT1 12 Pieces
7/10	TTXF05	Hand File Set TTX4 5 Pieces
8/10	TTDCT05	Cutting Tool Set TT2 5 Pieces
8/10	TTK40	Knife Set TT1 40 Pieces
8/10	TTPC09	Punch & Chisel Set TT1 9 Pieces
8/10	TTX03	Storage Tray TTX4 8 Compartments
9/10	TT1236	Combination Spanner Set TT1 12 Pieces
9/10	TT6508R	Ratcheting Spanner Set R TT1 8 Pieces
9/10	TT6208	Double Open Ended Spanner Set TT1 8 Pieces
9/10	TT6010M	Stubby Combination Spanner Set TT1 10 Pieces
9/10	TTX2032	Combination Spanner Set TTX4 7 Pieces

Drawer	Item ID	Description
10/10	TTX2640	Combination Spanner Set AF TTX4 7 Pieces
10/10	TT3592	Combination Spanner Set AF TT1 8 Pieces
10/10	TTRORS	Ratcheting Ring Spanner Set TT1 6 Pieces
10/10	TT6506	Double Flex Wrench Set TT1 6 Pieces
10/10	TTBS35	1/4" & 3/8" Bit Socket Set TT1 35 Pieces
1/9	TTBE18	Stud Extractor Set TT1 18 Pieces
1/9	TT9015HX	3/8" & 1/2" Hex Impact Skt Set DIN TT1 15 Pieces
1/9	TT9024	1/4" & 3/8" Impact Skt Set ANSI TT1 24 Pieces
1/9	TT9212TX	1/2" TX Impact Socket Set DIN TT1 12 Pieces
1/9	TT9207	1/2" Impact Accessories Set DIN TT1 11 Pieces
1/9	TT9116N	1/2" Impact Socket Set ANSI TT1 16 Pieces
1/9	TTX3404	3/4" Ratchet & Accessories Set TTX4 4 Pieces
1/9	TTD9416	3/4" Impact Socket Set DIN TT2 12 Pieces
2/9	TTV440	Insulated Plier Set TT1 4 Pieces
2/9	TTDV910N	Insulated Screwdriver Set Mixed TT2 6 Pieces
2/9	TTHEX23	1/2" Hex Bit Socket Set TT1 23 Pieces
2/9	TTXND	Nut Driver Set TTX4 9 Pieces
3/9	TTVG05	Power Grip Plier Set TT1 5 Pieces
3/9	TTADJ04	Adjustable Wrench Set TT1 4 Pieces
3/9	TTCP121	Crimping Plier Set TT1 121 Pieces
3/9	TTCP04	Crimping Plier Set TT1 4 Pieces
3/9	TTX6311	Double Ring Spanner Set TTX4 11 Pieces
4/9	TTPS09	General Tool Set BP TT4 9 Pieces
4/9	TTX1292	1/2" Torque Wrench 40-210 Nm TTX4
5/9	TTSPSG	Power Crip Plier Set TT4 4 Pieces
5/9	TTX3892	3/8" Torque Wrench Set TTX4 22 Pieces
6/9	TTDTD34	Tap and Die Set TT2 34 Pieces
6/9	TTD01	Storage Tray TT2 8 Compartments
6/9	TTX01	Storage Tray TTX4 6 Compartments
7/9	TTNR81	Nutsert Gun Set TT1 81 Pieces
7/9	TTHR81	Rivet Gun Set TT1 81 Pieces
7/9	TTID20	1/2" Impact Driver Set TT1 20 Pieces
7/9	TTHP08	Hook & Pin Wrench Set TT1 8 Pieces
7/9	TTXPB3	Pry Bar Set Roll/Heel TTX4 3 Pieces
9/9	TTOS16	Oil Service Set TT1 16 Pieces
9/9	TTSN11	Extractor & Nut Splitter Set TT1 11 Pieces
9/9	TT804	Puller Set TT1 4 Pieces
9/9	TTHC03	Hose Clamp Set TT1 3 Pieces
9/9	TTXPB3A	Pry Bar Set TTX4 3 Pieces

Item ID: **TCMONSTER02**



TT Series | Tool Kits

TT  
SERIES



37" PRO STACK TT TOOL KIT 1034 PIECES

- A complete tool kit covering the requirements of most users
- All the tools are laid out in individual tool modules using the TengTools Tool Control system
- Easy to see if any tools have been mislaid or lost helping to prevent leaving them with the work piece
- The kit contains 71 individual tool modules containing 1034 individual pieces
- Supplied in a red TengTools 37" 12 drawer stack system with a 5 drawer full depth top box and 7 drawer roller cabinet
- All in TengTools red with the distinctive TengTools eyes logo on the drop front on the top box and on the bottom drawer on the cabinet

- 12 Drawer**
  - 37" Wide Cabinet**
  - Heavy Gauge Steel**
  - 5-Step Rust Protection**
  - 5" Castor Wheels with Brakes**
  - 3 Step Ball Bearing Slides**
  - Comfort Grip Handle**
  - Combination Lock**
- 1034 Pieces** **231.7 kg**



Drawer 1/5

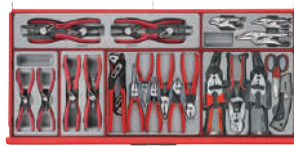

Drawer 2/5



Drawer 3/5



Drawer 4/5



Drawer 5/5

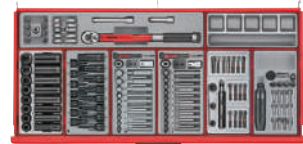

Drawer 1/7



Drawer 2/7



Drawer 3/7



Drawer 4/7



Drawer 5/7



Drawer 6/7



Drawer 7/7

Drawer	Item ID	Description
Storage	TC205NF	37" PRO Top Box 5 Drawers Red
	TCW207N	37" PRO Cabinet 7 Drawers Red
1/5	TTXEXT13	Extension Bars Set TTX4 13 Pieces
1/5	TTZ01	Storage Tray TTX2 6 Compartments
1/5	TT1435	1/4" Socket Set 6 pt TT1 35 Pieces
1/5	TT3819	3/8" Socket Set 6 pt TT1 19 Pieces
1/5	TT1217	1/2" Socket Set 12 pt TT1 17 Pieces
1/5	TT1205	1/2" Ratchet & Accessories Set TT1 5 Pieces
1/5	TTTX30	3/8" TX Bit Socket Set TT1 30 Pieces
1/5	TTTXH15	1/2" Hex & TX Bit Socket Set TT1 15 Pieces
2/5	TTX474-9E	Circlip Plier Set PRO 40-100 mm TTX4 4 Pieces
2/5	TTZVG03	Power Grip Plier Set TTX2 3 Pieces
2/5	TT474-5E	Circlip Plier Set PRO 10-25 mm TT1 4 Pieces
2/5	TT474-7E	Circlip Plier Set PRO 19-60 mm TT1 4 Pieces
2/5	TTDCT05	Cutting Tool Set TT2 5 Pieces
2/5	TTD441	Plier Set Vinyl Grip TT2 8 Pieces
3/5	TTX918N	Screwdriver Set Flat & PH TTX4 8 Pieces
3/5	TTZ01	Storage Tray TTX2 6 Compartments
3/5	TT917N	Screwdriver Set Mixed TT1 7 Pieces
3/5	TT917TXN	Screwdriver Set TX & TPX TT1 7 Pieces
3/5	TTMD74	Ratcheting Screwdriver Bit Set TT1 74 Pieces
3/5	TTSR04	Scraper Set TT1 4 Pieces
3/5	TTHR81	Rivet Gun Set TT1 81 Pieces
3/5	TTNR81	Nutsert Gun Set TT1 81 Pieces
4/5	TTX2032	Combination Spanner Set TTX4 7 Pieces
4/5	TTZ01	Storage Tray TTX2 6 Compartments
4/5	TT1236	Combination Spanner Set TT1 12 Pieces
4/5	TT6010M	Stubby Combination Spanner Set TT1 10 Pieces
4/5	TT6508R	Ratcheting Spanner Set R TT1 8 Pieces
4/5	TT6506	Double Flex Wrench Set TT1 6 Pieces
4/5	TTHP08	Hook & Pin Wrench Set TT1 8 Pieces
4/5	TT6508RF	Ratcheting Spanner Set RF TT1 8 Pieces
5/5	TTX2640	Combination Spanner Set AF TTX4 7 Pieces
5/5	TTZ01	Storage Tray TTX2 6 Compartments
5/5	TT1215AF	1/2" Socket Set 12 pt AF TT1 15 Pieces
5/5	TTAF32	1/4" & 3/8" Socket Set AF 6 pt TT1 32 Pieces
5/5	TT3592	Combination Spanner Set AF TT1 8 Pieces
5/5	TTHEX7	T-Handle Ball Point Hex Key Set TT1 7 Pieces
5/5	TTTX7	T-Handle TX/TPX Key Set TT1 7 Pieces
5/5	TTHEX7AF	T-Handle Hex Key Set AF TT1 7 Pieces
1/7	TTX3892	3/8" Torque Wrench Set TTX4 22 Pieces
1/7	TTZ01	Storage Tray TTX2 6 Compartments
1/7	TT9116N	1/2" Impact Socket Set ANSI TT1 16 Pieces

Drawer	Item ID	Description
1/7	TT9015HX	3/8" & 1/2" Hex Impact Skt Set DIN TT1 15 Pieces
1/7	TTHEX23	1/2" Hex Bit Socket Set TT1 23 Pieces
1/7	TTTX23	1/2" TX Bit Socket Set TT1 23 Pieces
1/7	TTID20	1/2" Impact Driver Set TT1 20 Pieces
1/7	TTID19	1/4" Impact Driver Set TT1 19 Pieces
2/7	TTX1292	1/2" Torque Wrench 40-210 Nm TTX4
2/7	TTZ01	Storage Tray TTX2 6 Compartments
2/7	TTV907N	Insulated Screwdriver Set Mixed TT1 7 Pieces
2/7	TTV440	Insulated Plier Set TT1 4 Pieces
2/7	TTPS09	General Tool Set BP TT4 9 Pieces
3/7	TTXMDTN	Power Through Screwdriver Set TTX4 5 Pieces
3/7	TTZ01	Storage Tray TTX2 6 Compartments
3/7	TTTM03	Inspection Set TT1 3 Pieces
3/7	TTSD38	Torque Screwdriver Set TT1 38 Pieces
3/7	TTSN11	Extractor & Nut Splitter Set TT1 11 Pieces
3/7	TTTD17	Tap and Die Set TT1 17 Pieces
3/7	TTM116	Mini Pliers & Screwdriver Set TT1 16 Pieces
3/7	TT804	Puller Set TT1 4 Pieces
4/7	TTXND	Nut Driver Set TTX4 9 Pieces
4/7	TTX6311	Double Ring Spanner Set TTX4 11 Pieces
4/7	TTXF05	Hand File Set TTX4 5 Pieces
4/7	TTZ01	Storage Tray TTX2 6 Compartments
4/7	TTCP121	Crimping Plier Set TT1 121 Pieces
4/7	TTHC03	Hose Clamp Set TT1 3 Pieces
7/7	TTX3404	3/4" Ratchet & Accessories Set TTX4 4 Pieces
7/7	TTX3414	3/4" Socket Set 6 pt TTX4 14 Pieces
7/7	TTXPB3A	Pry Bar Set TTX4 3 Pieces
7/7	TTZ01	Storage Tray TTX2 6 Compartments
7/7	TTOS16	Oil Service Set TT1 16 Pieces
7/7	TTPC09	Punch & Chisel Set TT1 9 Pieces

Item ID: **TCMM1034N**



# MEGA MASTER™

## 26" PRO MEGA MASTER TT TOOL KIT

- A complete tool kit covering the requirements of most users
- All the tools are laid out in individual tool modules using the TengTools Tool Control system
- Easy to see if any tools have been mislaid or lost helping to prevent leaving them with the work piece
- Supplied in a red TengTools 26" 19 drawer stack system with a top box, middle box and roller cabinet
- Distinctive TengTools eyes logo on the drop front of the top box

- 19 Drawer
- 26" Wide Cabinet
- Heavy Gauge Steel
- 5-Step Rust Protection
- 5" Castor Wheels with Brakes
- 3 Step Ball Bearing Slides
- Comfort Grip Handle
- Combination Lock

**1001** Pieces 220 kg



Drawer 4/6



Drawer 5/6



Drawer 6/6



Drawer 1, 2, 3/6



Drawer 1/3



Drawer 2/3



Drawer 3/3



Drawer 1/10



Drawer 2/10



Drawer 3/10



Drawer 4/10



Drawer 5/10

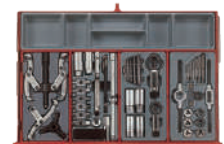

Drawer 6/10



Drawer 7/10



Drawer 8/10



Drawer 9/10



Drawer 10/10

Drawer	Item ID	Description
Storage	TC806NF	26" PRO Top Box 6 Drawers Red
	TC803N	26" PRO Middle Box 3 Drawers Red
	TCW810N	26" PRO Cabinet 10 Drawers Red
1/6	TM708	Mini Screwdriver Set Mixed 8 Pieces
1/6	1479MM	Ball Point Hex Key Set 9 Pieces
1/6	1479AF	Ball Point Hex Key Set AF 9 Pieces
1/6	1479TX	TX Key Set 9 Pieces
4/6	TTHEX7	T-Handle Ball Point Hex Key Set TTI 7 Pieces
4/6	TTNR81	Nutsert Gun Set TTI 81 Pieces
4/6	TTTX7	T-Handle TX/TPX Key Set TTI 7 Pieces
4/6	TTHR81	Rivet Gun Set TTI 81 Pieces
5/6	TTI236	Combination Spanner Set TTI 12 Pieces
5/6	TTALU	Clip Rail Set TTI 32 Pieces
5/6	TTTM03	Inspection Set TTI 3 Pieces
5/6	TT6208	Double Open Ended Spanner Set TTI 8 Pieces
6/6	TTPS09	General Tool Set BP TT4 9 Pieces
1/3	TTPC09	Punch & Chisel Set TTI 9 Pieces
1/3	TTID20	1/2" Impact Driver Set TTI 20 Pieces
1/3	TTSR04	Scraper Set TTI 4 Pieces
1/3	TT00	Storage Tray With Tool Holder TTI
2/3	TTHP08	Hook & Pin Wrench Set TTI 8 Pieces
2/3	TT6506	Double Flex Wrench Set TTI 6 Pieces
2/3	TT6010M	Stubby Combination Spanner Set TTI 10 Pieces
2/3	TT3592	Combination Spanner Set AF TTI 8 Pieces
3/3	TTXPB3	Pry Bar Set Roll/Heel TTX4 3 Pieces
3/3	TTX6311	Double Ring Spanner Set TTX4 11 Pieces
1/10	TTXEXT13	Extension Bars Set TTX4 13 Pieces
1/10	TTI205	1/2" Ratchet & Accessories Set TTI 5 Pieces
1/10	TTI435	1/4" Socket Set 6 pt TTI 35 Pieces
1/10	TT3819	3/8" Socket Set 6 pt TTI 19 Pieces
1/10	TTI217	1/2" Socket Set 12 pt TTI 17 Pieces
2/10	TTTX23	1/2" TX Bit Socket Set TTI 23 Pieces
2/10	TTHEX23	1/2" Hex Bit Socket Set TTI 23 Pieces
2/10	TTALU	Clip Rail Set TTI 32 Pieces
2/10	TTXND	Nut Driver Set TTX4 9 Pieces
2/10	TT9116N	1/2" Impact Socket Set ANSI TTI 16 Pieces
3/10	TTX918N	Screwdriver Set Flat & PH TTX4 8 Pieces
3/10	TT917N	Screwdriver Set Mixed TTI 7 Pieces
3/10	TT917TXN	Screwdriver Set TX & TPX TTI 7 Pieces
3/10	TTMD74	Ratcheting Screwdriver Bit Set TTI 74 Pieces
3/10	TTMI16	Mini Pliers & Screwdriver Set TTI 16 Pieces
4/10	TTX474-9	Circlip Plier Set 40-100 mm TTX4 4 Pieces

Drawer	Item ID	Description
4/10	TT440-T	Plier Set TPR Crip TTI 4 Pieces
4/10	TT474-7	Circlip Plier Set 19-60 mm TTI 4 Pieces
4/10	TT474-5	Circlip Plier Set 10-25 mm TTI 4 Pieces
4/10	TTHC03	Hose Clamp Set TTI 3 Pieces
5/10	TTX1292	1/2" Torque Wrench 40-210 Nm TTX4
5/10	TTV440	Insulated Plier Set TTI 4 Pieces
5/10	TTCP121	Crimping Plier Set TTI 121 Pieces
5/10	TTV907N	Insulated Screwdriver Set Mixed TTI 7 Pieces
5/10	TT01	Storage Tray TTI 7 Compartments
6/10	TTX01	Storage Tray TTX4 6 Compartments
6/10	TT804	Puller Set TTI 4 Pieces
6/10	TTOS16	Oil Service Set TTI 16 Pieces
6/10	TTSN11	Extractor & Nut Splitter Set TTI 11 Pieces
6/10	TTTD17	Tap and Die Set TTI 17 Pieces
7/10	TTX2032	Combination Spanner Set TTX4 7 Pieces
7/10	TTX3892	3/8" Torque Wrench Set TTX4 22 Pieces
7/10	TTXPB3A	Pry Bar Set TTX4 3 Pieces
8/10	TTXND	Nut Driver Set TTX4 9 Pieces
8/10	TTSPSPG	Power Grip Plier Set TT4 4 Pieces
9/10	TTX2640	Combination Spanner Set AF TTX4 7 Pieces
9/10	TTTXH15	1/2" Hex & TX Bit Socket Set TTI 15 Pieces
9/10	TTI215AF	1/2" Socket Set 12 pt AF TTI 15 Pieces
9/10	TTAF32	1/4" & 3/8" Socket Set AF 6 pt TTI 32 Pieces
9/10	TTTX30	3/8" TX Bit Socket Set TTI 30 Pieces
10/10	TTX3404	3/4" Ratchet & Accessories Set TTX4 4 Pieces
10/10	TTX3414	3/4" Socket Set 6 pt TTX4 14 Pieces
-	ABS-TOP	ABS Top for Roller Cabinet
-	580	Magnetic Bits Tray

Item ID: **TCMM1001N**

## TT Series | Tool Kits

TT  
SERIES

## MEGA MASTER™

## 26" PRO MEGA MASTER TT TOOL KIT

- 1,001 piece Mega Master tool kit
- A complete tool kit covering the requirements of most users
- All the tools are laid out in individual tool modules using the TengTools Tool Control system
- Easy to see if any tools have been mislaid or lost helping to prevent leaving them with the work piece
- Supplied in a black TengTools 26" 19 drawer stack system with a top box, middle box and roller cabinet

- 19 Drawer
- 26" Wide Cabinet
- Heavy Gauge Steel
- 5-Step Rust Protection
- 5" Castor Wheels with Brakes
- 3 Step Ball Bearing Slides
- Comfort Grip Handle
- Combination Lock

1001  
Pieces  220 kg

Drawer 4/6



Drawer 5/6



Drawer 6/6



Drawer 1, 2, 3/6



Drawer 1/3



Drawer 2/3



Drawer 3/3



Drawer 1/10



Drawer 2/10



Drawer 3/10



Drawer 4/10



Drawer 5/10

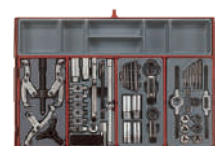

Drawer 6/10



Drawer 7/10



Drawer 8/10



Drawer 9/10



Drawer 10/10

Drawer	Item ID	Description
Storage	TC806NBK	26" PRO Top Box 6 Drawers Black
	TC803NBK	26" PRO Middle Box 3 Drawers Black
	TCW810NBK	26" PRO Cabinet 10 Drawers Black
1/6	TM708	Mini Screwdriver Set Mixed 8 Pieces
1/6	1479MM	Ball Point Hex Key Set 9 Pieces
1/6	1479AF	Ball Point Hex Key Set AF 9 Pieces
1/6	1479TX	TX Key Set 9 Pieces
4/6	TTHX7	T-Handle Ball Point Hex Key Set TTI 7 Pieces
4/6	TTR81	Nutsert Gun Set TTI 81 Pieces
4/6	TTX7	T-Handle TX/TPX Key Set TTI 7 Pieces
4/6	TTHR81	Rivet Gun Set TTI 81 Pieces
5/6	TTI236	Combination Spanner Set TTI 12 Pieces
5/6	TTALU	Clip Rail Set TTI 32 Pieces
5/6	TTTM03	Inspection Set TTI 3 Pieces
5/6	TT6208	Double Open Ended Spanner Set TTI 8 Pieces
6/6	TTPS09	General Tool Set BP TT4 9 Pieces
1/3	TTPC09	Punch & Chisel Set TTI 9 Pieces
1/3	TTID20	1/2" Impact Driver Set TTI 20 Pieces
1/3	TTSR04	Scraper Set TTI 4 Pieces
1/3	TT00	Storage Tray With Tool Holder TTI
2/3	TTHP08	Hook & Pin Wrench Set TTI 8 Pieces
2/3	TT6506	Double Flex Wrench Set TTI 6 Pieces
2/3	TT6010M	Stubby Combination Spanner Set TTI 10 Pieces
2/3	TT3592	Combination Spanner Set AF TTI 8 Pieces
3/3	TTXPB3	Pry Bar Set Roll/Heel TTX4 3 Pieces
3/3	TTX6311	Double Ring Spanner Set TTX4 11 Pieces
1/10	TTXEXT13	Extension Bars Set TTX4 13 Pieces
1/10	TTI205	1/2" Ratchet & Accessories Set TTI 5 Pieces
1/10	TTI435	1/4" Socket Set 6 pt TTI 35 Pieces
1/10	TT3819	3/8" Socket Set 6 pt TTI 19 Pieces
1/10	TTI217	1/2" Socket Set 12 pt TTI 17 Pieces
2/10	TTTX23	1/2" TX Bit Socket Set TTI 23 Pieces
2/10	TTHX23	1/2" Hex Bit Socket Set TTI 23 Pieces
2/10	TTALU	Clip Rail Set TTI 32 Pieces
2/10	TTXMDTN	Power Through Screwdriver Set TTX4 5 Pieces
2/10	TT9116N	1/2" Impact Socket Set ANSI TTI 16 Pieces
3/10	TTX918N	Screwdriver Set Flat & PH TTX4 8 Pieces
3/10	TT917N	Screwdriver Set Mixed TTI 7 Pieces
3/10	TT917TXN	Screwdriver Set TX & TPX TTI 7 Pieces
3/10	TTMD74	Ratcheting Screwdriver Bit Set TTI 74 Pieces
3/10	TTMI16	Mini Pliers & Screwdriver Set TTI 16 Pieces
4/10	TTX474-9	Circlip Plier Set 40-100 mm TTX4 4 Pieces

Drawer	Item ID	Description
4/10	TT440-T	Plier Set TPR Crip TTI 4 Pieces
4/10	TT474-7	Circlip Plier Set 19-60 mm TTI 4 Pieces
4/10	TT474-5	Circlip Plier Set 10-25 mm TTI 4 Pieces
4/10	TTHC03	Hose Clamp Set TTI 3 Pieces
5/10	TTX1292	1/2" Torque Wrench 40-210 Nm TTX4
5/10	TTV440	Insulated Plier Set TTI 4 Pieces
5/10	TTCP121	Crimping Plier Set TTI 121 Pieces
5/10	TTV907N	Insulated Screwdriver Set Mixed TTI 7 Pieces
5/10	TT01	Storage Tray TTI 7 Compartments
6/10	TTX01	Storage Tray TTX4 6 Compartments
6/10	TT804	Puller Set TTI 4 Pieces
6/10	TTOS16	Oil Service Set TTI 16 Pieces
6/10	TTSN11	Extractor & Nut Splitter Set TTI 11 Pieces
6/10	TTTD17	Tap and Die Set TTI 17 Pieces
7/10	TTX2032	Combination Spanner Set TTX4 7 Pieces
7/10	TTX3892	3/8" Torque Wrench Set TTX4 22 Pieces
7/10	TTXPB3A	Pry Bar Set TTX4 3 Pieces
8/10	TTXND	Nut Driver Set TTX4 9 Pieces
8/10	TTSPSPG	Power Grip Plier Set TT4 4 Pieces
9/10	TTX2640	Combination Spanner Set AF TTX4 7 Pieces
9/10	TTTXH15	1/2" Hex & TX Bit Socket Set TTI 15 Pieces
9/10	TTI215AF	1/2" Socket Set 12 pt AF TTI 15 Pieces
9/10	TTAF32	1/4" & 3/8" Socket Set AF 6 pt TTI 32 Pieces
9/10	TTTX30	3/8" TX Bit Socket Set TTI 30 Pieces
10/10	TTX3404	3/4" Ratchet & Accessories Set TTX4 4 Pieces
10/10	TTX3414	3/4" Socket Set 6 pt TTX4 14 Pieces
-	ABS-TOP	ABS Top for Roller Cabinet
-	580	Magnetic Bits Tray

Item ID: **TCMM1001BK**

**A Personalised Tool Box Sticker**

This is now available to you through your local stockist. Provide an image that you would like to use and we will customise your tool kit for you. Images need to be supplied as high resolution jpeg, PDF, or a vector format.

Item ID: **TCMM1001P**

TT Series | Tool Kits

TT SERIES



26" PRO STACK TT TOOL KIT 1055 PIECES RED

- A complete tool kit covering the requirements of most users
- All the tools are laid out in individual tool modules using the TengTools Tool Control system
- Easy to see if any tools have been mislaid or lost helping to prevent leaving them with the work piece
- Supplied in a red TengTools 26" 16 drawer stack system with a top box, middle box and roller cabinet with the distinctive TengTools eyes logo on the drop front of the top box

- 16 Drawer
- 26" Wide Cabinet
- Heavy Gauge Steel
- 5-Step Rust Protection
- 5" Castor Wheels with Brakes
- 3 Step Ball Bearing Slides
- Comfort Grip Handle
- Combination Lock

1055 Pieces 170.3 kg



Side Panel



Drawer 1, 2, 3/6



Drawer 4/6



Drawer 5/6



Drawer 6/6



Drawer 1/3



Drawer 2/3



Drawer 3/3



Drawer 1/7



Drawer 2/7



Drawer 3/7



Drawer 4/7

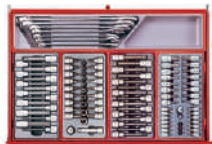

Drawer 5/7



Drawer 6/7



Drawer 7/7

Drawer	Item ID	Description
Storage	TC806NF	26" PRO Top Box 6 Drawers Red
	TC803N	26" PRO Middle Box 3 Drawers Red
	TCW807N	26" PRO Cabinet 7 Drawers Red
	TCW-SP01	Side Panel for Cabinet
	TCW-HK10	Tool Hooks 7 x 90° & 3 x 45°
2/6	1476NTX1	Folding Ball Point TX Key Set 8 Pieces
2/6	1477NX	Folding Key Set Mixed 8 Pieces
2/6	587H	Magnifying Glass with LED
4/6	TT1435	1/4" Socket Set 6 pt TTI 35 Pieces
4/6	TT3819	3/8" Socket Set 6 pt TTI 19 Pieces
4/6	TT1218	1/2" Socket Set 12 pt TTI 17 Pieces
4/6	TT1211	1/2" Socket Set 12 pt TTI 11 Pieces
5/6	TT1236	Combination Spanner Set TTI 12 Pieces
5/6	TT6010M	Stubby Combination Spanner Set TTI 10 Pieces
5/6	TT6508RS	Ratcheting Spanner Set RS TTI 8 Pieces
5/6	TTADJ04	Adjustable Wrench Set TTI 4 Pieces
6/6	TTHEX7	T-Handle Ball Point Hex Key Set TTI 7 Pieces
6/6	TTTX7	T-Handle TX/TPX Key Set TTI 7 Pieces
6/6	TTHT28	Ball Point Hex & TX Key Set TTI 28 Pieces
6/6	TT804	Puller Set TTI 4 Pieces
1/3	TTD441-T	Plier Set TPR Grip TT2 8 Pieces
1/3	TT474-7	Circlip Plier Set 19-60 mm TTI 4 Pieces
1/3	TTM116	Mini Pliers & Screwdriver Set TTI 16 Pieces
2/3	TTCP04	Crimping Plier Set TTI 4 Pieces
2/3	TTCP121	Crimping Plier Set TTI 121 Pieces
2/3	TTV440	Insulated Plier Set TTI 4 Pieces
2/3	TTV907N	Insulated Screwdriver Set Mixed TTI 7 Pieces
3/3	TTTF10	Flaring Tool Set TTI 10 Pieces
3/3	TTK40	Knife Set TTI 40 Pieces
3/3	TTDCT05	Cutting Tool Set TT2 5 Pieces
1/7	TTD914N	Screwdriver Set Mixed TT2 14 Pieces
1/7	TT917TXN	Screwdriver Set TX & TPX TTI 7 Pieces
1/7	TTMD74	Ratcheting Screwdriver Bit Set TTI 74 Pieces
1/7	TTX918N	Screwdriver Set Flat & PH TTX4 8 Pieces
2/7	TTHR81	Rivet Gun Set TTI 81 Pieces
2/7	TTNR81	Nutsert Gun Set TTI 81 Pieces
2/7	TTSD39	Torque Screwdriver Set TTI 39 Pieces
2/7	TTBE18	Stud Extractor Set TTI 18 Pieces
2/7	TTX1292	1/2" Torque Wrench 40-210 Nm TTX4
3/7	TTVG05	Power Grip Plier Set TTI 5 Pieces

Drawer	Item ID	Description
3/7	TTID20	1/2" Impact Driver Set TTI 20 Pieces
3/7	TTPC09	Punch & Chisel Set TTI 9 Pieces
3/7	TTNF12	Needle File Set TTI 12 Pieces
3/7	TTXEXT13	Extension Bars Set TTX4 13 Pieces
4/7	TTAF32	1/4" & 3/8" Socket Set AF 6 pt TTI 32 Pieces
4/7	TT1215AF	1/2" Socket Set 12 pt AF TTI 15 Pieces
4/7	TTBM	Measuring Tool Set TTI 4 Pieces
4/7	TTM08	Inspection Set TTI 8 Pieces
4/7	TTXTB09	3/8" Long T Bar Socket Set TTX4 9 Pieces
5/7	TTTXH15	1/2" Long Hex & TX Bit Socket Set TTI 15 Pieces
5/7	TTTX30	3/8" TX Bit Socket Set TTI 30 Pieces
5/7	TTRS15	1/2" Ribe & XZN Bit Socket Set TTI 15 Pieces
5/7	TTBS35	1/4" & 3/8" Bit Socket Set TTI 35 Pieces
5/7	TTX2032	Combination Spanner Set TTX4 7 Pieces
6/7	TT9024	1/4" & 3/8" Impact Skt Set ANSI TTI 24 Pieces
6/7	TT9207	1/2" Impact Accessories Set DIN TTI 11 Pieces
6/7	TT9116N	1/2" Impact Socket Set ANSI TTI 16 Pieces
6/7	TTTS08	1/2" Torque Sticks & Wheel Nut Set TTI 8 Pieces
6/7	TTXPB3	Pry Bar Set Roll/Heel TTX4 3 Pieces
7/7	583M	Magnetic Bracelet
7/7	TM149	Hook & Pick Set 4 Pieces
7/7	9850	Circuit Tester
7/7	DB034	Drill Bit Set 1.0-13.0 mm 34 Pieces
-	580	Magnetic Bits Tray

Item ID: **TCMM1055N**



TT Series | Tool Kits

TT SERIES



26" PRO STACK TT TOOL KIT 715 PIECES RED

- A complete tool kit covering the requirements of most users
- The tools are laid out in individual tool modules using the TengTools Tool Control system
- Larger tools are fitted to the removable free standing side plate for easier storage and use
- Easy to see if any tools have been mislaid or lost helping to prevent leaving them with the work piece
- Supplied in a red TengTools 26" 19 drawer stack system with a top box, middle box and roller cabinet with the distinctive TengTools eyes logo on the drop front of the top box
- A comprehensive selection of tools using 11 of the available 19 drawers ensuring that space is still available to add to the kit if needed

- 19 Drawer
- 26" Wide Cabinet
- Heavy Gauge Steel
- 5-Step Rust Protection
- 5" Castor Wheels with Brakes
- 3 Step Ball Bearing Slides
- Comfort Grip Handle
- Combination Lock

715 Pieces 172.7 kg



Side Plate



Drawer 5/6



Drawer 1, 2, 3/6



Drawer 4/6



Drawer 6/6



Drawer 1/3



Drawer 2/3



Drawer 3/3



Drawer 1/10



Drawer 2/10



Drawer 3/10



Drawer 4/10



Drawer 5/10



Drawer 6/10



Drawer 7/10



Drawer 8/10



Drawer 9/10



Drawer 10/10

Drawer	Item ID	Description
Storage	TC806NF	26" PRO Top Box 6 Drawers Red
	TC803N	26" PRO Middle Box 3 Drawers Red
	TCW810N	26" PRO Cabinet 10 Drawers Red
	TCW-SP01	Side Panel for Cabinet
	TCW-HK10	Tool Hooks 7 x 90° & 3 x 45°
4/6	TTM116	Mini Pliers & Screwdriver Set TT1 16 Pieces
4/6	TTID20	1/2" Impact Driver Set TT1 20 Pieces
4/6	TTPC09	Punch & Chisel Set TT1 9 Pieces
4/6	TT01	Storage Tray TT1 7 Compartments
5/6	TT917N	Screwdriver Set Mixed TT1 7 Pieces
5/6	TT440-T	Plier Set TPR Grip TT1 4 Pieces
5/6	TT917TXN	Screwdriver Set TX & TPX TT1 7 Pieces
5/6	TTMD74	Ratcheting Screwdriver Bit Set TT1 74 Pieces
6/6	TTSPSG	Power Grip Plier Set TT4 4 Pieces
1/3	TT804	Puller Set TT1 4 Pieces
1/3	TTNR81	Nutsert Gun Set TT1 81 Pieces
1/3	TTTD17	Tap and Die Set TT1 17 Pieces
1/3	TTHP08	Hook & Pin Wrench Set TT1 8 Pieces
2/3	TTHEX7	T-Handle Ball Point Hex Key Set TT1 7 Pieces
2/3	TT474-7	Circlip Plier Set 19-60 mm TT1 4 Pieces
2/3	TTTX7	T-Handle TX/TPX Key Set TT1 7 Pieces
2/3	TTHR81	Rivet Gun Set TT1 81 Pieces
3/3	TTX6311	Double Ring Spanner Set TTX4 11 Pieces
3/3	TTXPB3	Pry Bar Set Roll/Heel TTX4 3 Pieces
1/10	TTXEXT13	Extension Bars Set TTX4 13 Pieces
1/10	TT1435	1/4" Socket Set 6 pt TT1 35 Pieces
1/10	TT3819	3/8" Socket Set 6 pt TT1 19 Pieces
1/10	TT1217	1/2" Socket Set 12 pt TT1 17 Pieces
1/10	TT1205	1/2" Ratchet & Accessories Set TT1 5 Pieces
2/10	TTX1292	1/2" Torque Wrench 40-210 Nm TTX4
2/10	TT9116N	1/2" Impact Socket Set ANSI TT1 16 Pieces
2/10	TTHEX23	1/2" Hex Bit Socket Set TT1 23 Pieces
2/10	TTALU	Clip Rail Set TT1 32 Pieces
2/10	TTTX23	1/2" TX Bit Socket Set TT1 23 Pieces
7/10	TTX2032	Combination Spanner Set TTX4 7 Pieces
7/10	TT1236	Combination Spanner Set TT1 12 Pieces
7/10	TTSN11	Extractor & Nut Splitter Set TT1 11 Pieces
7/10	TTOS16	Oil Service Set TT1 16 Pieces
7/10	TTALU	Clip Rail Set TT1 32 Pieces
8/10	TTX918N	Screwdriver Set Flat & PH TTX4 8 Pieces

Drawer	Item ID	Description
8/10	TTPS09	General Tool Set BP TT4 9 Pieces
9/10	TTX2640	Combination Spanner Set AF TTX4 7 Pieces
9/10	TT3592	Combination Spanner Set AF TT1 8 Pieces
9/10	TTAF32	1/4" & 3/8" Socket Set AF 6 pt TT1 32 Pieces
9/10	TT1215AF	1/2" Socket Set 12 pt AF TT1 15 Pieces
9/10	TTTX30	3/8" TX Bit Socket Set TT1 30 Pieces

Item ID: **TCMM715N**

TT Series | Tool Kits

TT  
SERIES



26" PRO STACK TT TOOL KIT 600 PIECES RED

- A complete tool kit covering the requirements of most users
- The tools are laid out in individual tool modules using the TengTools Tool Control system
- Larger tools are fitted to the removable free standing side plate for easier storage and use
- Easy to see if any tools have been mislaid or lost helping to prevent leaving them with the work piece
- Supplied in a red TengTools 26" 16 drawer stack system with a top box, middle box and roller cabinet with the distinctive TengTools eyes logo on the drop front of the top box
- A comprehensive selection of tools using 11 of the available 16 drawers ensuring that space is still available to add to the kit if needed

- 16 Drawer
- 26" Wide Cabinet
- Heavy Gauge Steel
- 5-Step Rust Protection
- 5" Castor Wheels with Brakes
- 3 Step Ball Bearing Slides
- Comfort Grip Handle
- Combination Lock

600 Pieces 178.3 kg



Side Panel



Drawer 1, 2, 3/6



Drawer 4/6



Drawer 5/6



Drawer 6/6



Drawer 1/3

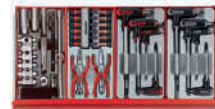

Drawer 2/3



Drawer 3/3

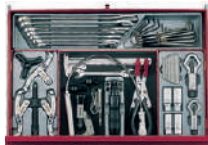

Drawer 1/7

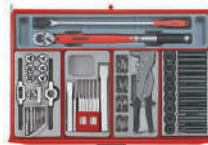

Drawer 2/7

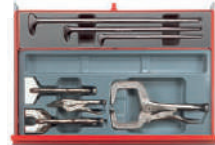

Drawer 3/7



Drawer 4/7



Drawer 5/7



Drawer 6/7



Drawer 7/7

Drawer	Item ID	Description
Storage	TC806NF	26" PRO Top Box 6 Drawers Red
	TC803N	26" PRO Middle Box 3 Drawers Red
	TCW807N	26" PRO Cabinet 7 Drawers Red
	TCW-SP01	Side Panel for Cabinet
	TCW-HK10	Tool Hooks 7 x 90° & 3 x 45°
4/6	TT1435	1/4" Socket Set 6 pt TT1 35 Pieces
4/6	TT3819	3/8" Socket Set 6 pt TT1 19 Pieces
4/6	TT1217	1/2" Socket Set 12 pt TT1 17 Pieces
4/6	TT1205	1/2" Ratchet & Accessories Set TT1 5 Pieces
5/6	TT1236	Combination Spanner Set TT1 12 Pieces
5/6	TT917N	Screwdriver Set Mixed TT1 7 Pieces
5/6	TT440	Plier Set Vinyl Grip TT1 4 Pieces
5/6	TTALU	Clip Rail Set TT1 32 Pieces
6/6	TTPS09	General Tool Set BP TT4 9 Pieces
1/3	TTXEXT13	Extension Bars Set TTX4 13 Pieces
1/3	TTX918N	Screwdriver Set Flat & PH TTX4 8 Pieces
2/3	TTOS16	Oil Service Set TT1 16 Pieces
2/3	TTM116	Mini Pliers & Screwdriver Set TT1 16 Pieces
2/3	TTHEX7	T-Handle Ball Point Hex Key Set TT1 7 Pieces
2/3	TTTX7	T-Handle TX/TPX Key Set TT1 7 Pieces
3/3	TT474-7	Circlip Plier Set 19-60 mm TT1 4 Pieces
3/3	TT917TXN	Screwdriver Set TX & TPX TT1 7 Pieces
3/3	TTHEX23	1/2" Hex Bit Socket Set TT1 23 Pieces
3/3	TTTX23	1/2" TX Bit Socket Set TT1 23 Pieces
1/7	1201	1/2" Flex Handle 450mm
1/7	1424	Hex Key Set AF 10 Pieces
1/7	1425	Hex Key Set 10 Pieces
1/7	1487	TX Key Set 7 Pieces
1/7	586	Flexible Light With Magnet
1/7	64101	Flare nut Wrench Metric 10 x 11mm
1/7	641213	Flare nut Wrench Metric 12 x 13mm
1/7	661416	Flare nut Wrench AF 7/16" x 1/2"
1/7	705	Mini Hacksaw
1/7	9850	Circuit Tester
1/7	CALD150	Digital Caliper 0-150mm
1/7	ID506	5/16" Impact Driver Set 6 Pieces
1/7	MB499-7T	Wire Stripping Plier TPR Grip
1/7	MD503N	Hose Clip Driver 6mm/7mm
1/7	SPBP20	Spark Plug Boot Plier

Drawer	Item ID	Description
1/7	TRC1012	Spark Plug Thread Cleaner 10 x 12mm
1/7	TRC1418	Spark Plug Thread Cleaner 14 x 18mm
1/7	TTX2032	Combination Spanner Set TTX4 7 Pieces
1/7	TT804	Puller Set TT1 4 Pieces
1/7	TTSN11	Extractor & Nut Splitter Set TT1 11 Pieces
2/7	TTX1292	1/2" Torque Wrench 40-210 Nm TTX4
2/7	TTTD17	Tap and Die Set TT1 17 Pieces
2/7	TTPC09	Punch & Chisel Set TT1 9 Pieces
2/7	TTHR81	Rivet Gun Set TT1 81 Pieces
2/7	TT9116N	1/2" Impact Socket Set ANSI TT1 16 Pieces
3/7	TTXPB3	Pry Bar Set Roll/Heel TTX4 3 Pieces
3/7	TTSPPG	Power Grip Plier Set TT4 4 Pieces
4/7	TTX2640	Combination Spanner Set AF TTX4 7 Pieces
4/7	TT3592	Combination Spanner Set AF TT1 8 Pieces
4/7	TTAF32	1/4" & 3/8" Socket Set AF 6 pt TT1 32 Pieces
4/7	TT1215AF	1/2" Socket Set 12 pt AF TT1 15 Pieces
4/7	TTALU	Clip Rail Set TT1 32 Pieces
5/7	TTX3414	3/4" Socket Set 6 pt TTX4 14 Pieces
5/7	TTX3404	3/4" Ratchet & Accessories Set TTX4 4 Pieces
5/7	TTX34AF	3/4" Socket Set 12 pt AF TTX4 14 Pieces
Side Plate	BC424	Bolt Cutter
	MB416	Groove Joint Water Pump Plier
	PWC18	Aluminium Pipe Wrench
	4008	Adjustable Wrench
-	580	Magnetic Bits Tray
-	TC-MAG	Magnetic Tool Rail

Item ID: **TCMM600**

TT Series | Tool Kits

TT SERIES



26" PRO STACK TT TOOL KIT 479 PIECES RED

- A complete tool kit covering the requirements of most users
- The tools are laid out in individual tool modules using the TengTools Tool Control system
- Easy to see if any tools have been mislaid or lost helping to prevent leaving them with the work piece
- Supplied in a red TengTools 26" 19 drawer stack system with a top box, middle box and roller cabinet with the distinctive TengTools eyes logo on the drop front of the top box
- A comprehensive selection of tools using 9 of the available 16 drawers ensuring that space is still available to add to the kit if needed

- 16 Drawer
  - 26" Wide Cabinet
  - Heavy Gauge Steel
  - 5-Step Rust Protection
  - 5" Castor Wheels with Brakes
  - 3 Step Ball Bearing Slides
  - Comfort Grip Handle
  - Combination Lock
- 479 Pieces 138.3 kg



Side Panel



Drawer 1, 2, 3/6



Drawer 4/6



Drawer 5/6



Drawer 6/6



Drawer 1/3

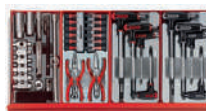

Drawer 2/3



Drawer 3/3



Drawer 1/7

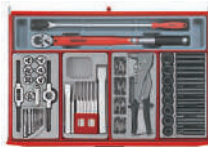

Drawer 2/7

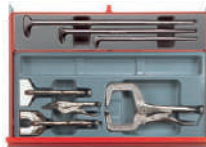

Drawer 3/7



Drawer 4/7



Drawer 5/7



Drawer 6/7



Drawer 7/7

Drawer	Item ID	Description
Storage	TC806NF	26" PRO Top Box 6 Drawers Red
	TC803N	26" PRO Middle Box 3 Drawers Red
	TCW807N	26" PRO Cabinet 7 Drawers Red
	TCW-SP01	Side Panel for Cabinet
	TCW-HK10	Tool Hooks 7 x 90° & 3 x 45°
4/6	TT1435	1/4" Socket Set 6 pt TT1 35 Pieces
4/6	TT3819	3/8" Socket Set 6 pt TT1 19 Pieces
4/6	TT1217	1/2" Socket Set 12 pt TT1 17 Pieces
4/6	TT1205	1/2" Ratchet & Accessories Set TT1 5 Pieces
5/6	TT1236	Combination Spanner Set TT1 12 Pieces
5/6	TT917N	Screwdriver Set Mixed TT1 7 Pieces
5/6	TT440	Plier Set Vinyl Grip TT1 4 Pieces
5/6	TTALU	Clip Rail Set TT1 32 Pieces
6/6	TTPS09	General Tool Set BP TT4 9 Pieces
1/3	TTXEXT13	Extension Bars Set TTX4 13 Pieces
1/3	TTX918N	Screwdriver Set Flat & PH TTX4 8 Pieces
2/3	TTOS16	Oil Service Set TT1 16 Pieces
2/3	TTM116	Mini Pliers & Screwdriver Set TT1 16 Pieces
2/3	TTHEX7	T-Handle Ball Point Hex Key Set TT1 7 Pieces
2/3	TTTX7	T-Handle TX/TPX Key Set TT1 7 Pieces
3/3	TT474-7	Circlip Plier Set 19-60 mm TT1 4 Pieces
3/3	TT917TXN	Screwdriver Set TX & TPX TT1 7 Pieces
3/3	TTHEX23	1/2" Hex Bit Socket Set TT1 23 Pieces
3/3	TTTX23	1/2" TX Bit Socket Set TT1 23 Pieces
1/7	1201	1/2" Flex Handle 450mm
1/7	1425	Hex Key Set 10 Pieces
1/7	1487	TX Key Set 7 Pieces
1/7	586	Flexible Light With Magnet
1/7	641011	Flare nut Wrench Metric 10 x 11mm
1/7	641213	Flare nut Wrench Metric 12 x 13mm
1/7	661416	Flare nut Wrench AF 7/16" x 1/2"
1/7	705	Mini Hacksaw
1/7	9850	Circuit Tester
1/7	CALD150	Digital Caliper 0-150mm
1/7	ID506	5/16" Impact Driver Set 6 Pieces
1/7	MB499-7T	Wire Stripping Plier TPR Grip
1/7	MD503N	Hose Clip Driver 6mm/7mm
1/7	SPBP20	Spark Plug Boot Plier
1/7	TF30	Pipe Cutter 3-32mm

Drawer	Item ID	Description
1/7	TRC1012	Spark Plug Thread Cleaner 10 x 12mm
1/7	TRC1418	Spark Plug Thread Cleaner 14 x 18mm
1/7	TTX2032	Combination Spanner Set TTX4 7 Pieces
1/7	TT804	Puller Set TT1 4 Pieces
1/7	TTSN11	Extractor & Nut Splitter Set TT1 11 Pieces
2/7	TTX1292	1/2" Torque Wrench 40-210 Nm TTX4
2/7	TTTD17	Tap and Die Set TT1 17 Pieces
2/7	TTPC09	Punch & Chisel Set TT1 9 Pieces
2/7	TTHR81	Rivet Gun Set TT1 81 Pieces
2/7	TT9116N	1/2" Impact Socket Set ANSI TT1 16 Pieces
3/7	TTXPB3	Pry Bar Set Roll/Heel TTX4 3 Pieces
3/7	TTPSPG	Power Grip Plier Set TT4 4 Pieces

Item ID: **TCMM479**

TT Series | Tool Kits

TT SERIES



26" STD STACK TT TOOL KIT 569 PIECES RED

- A complete tool kit covering the requirements of most users
- The tools are laid out in individual tool modules using the TengTools Tool Control system
- Easy to see if any tools have been mislaid or lost helping to prevent leaving them with the work piece
- Supplied in a red TengTools 26" 16 drawer standard stack system with a top box, middle box and roller cabinet with the distinctive TengTools eyes logo on the drop front of the top box
- A comprehensive selection of tools using 9 of the available 16 drawers ensuring that space is still available to add to the kit if needed

- 16 Drawer
- 26" Wide Cabinet
- Heavy Gauge Steel
- 5-Step Rust Protection
- 5" Castor Wheels with Brakes
- 3 Step Ball Bearing Slides
- Key Lock

569 Pieces 116 kg

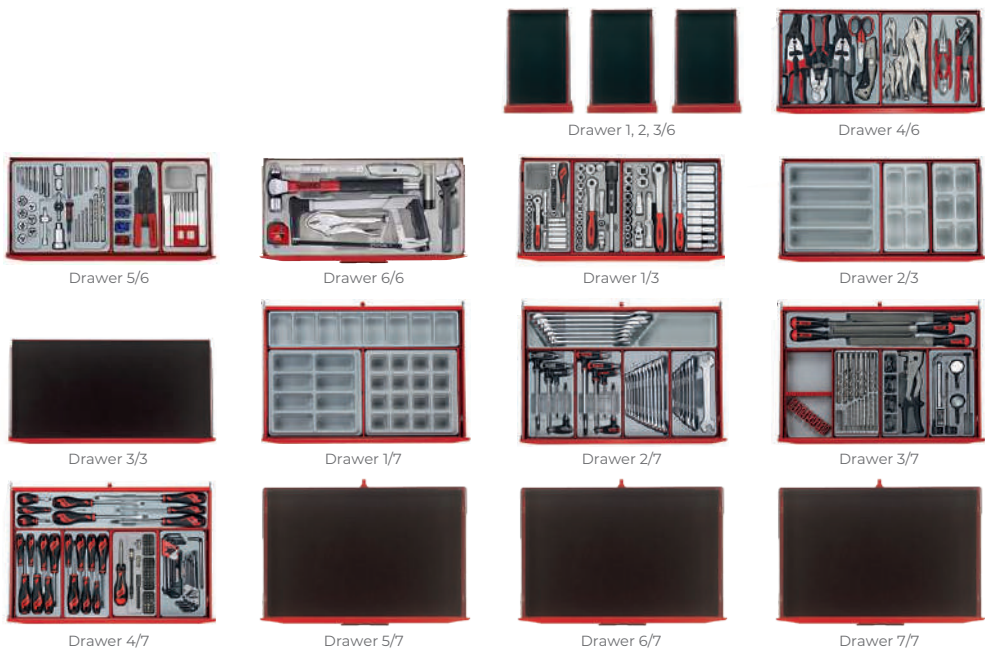

Drawer	Item ID	Description
Storage	TC806SV	26" STD Top Box 6 Drawers Red
	TC803SV	26" STD Middle Box 3 Drawers Red
	TCW707EV	26" STD Cabinet 7 Drawers Red
4/6	TTDCT05	Cutting Tool Set TT2 5 Pieces
4/6	TT440	Plier Set Vinyl Grip TT1 4 Pieces
4/6	TTVG05	Power Grip Plier Set TT1 5 Pieces
5/6	TTPC09	Punch & Chisel Set TT1 9 Pieces
5/6	TTCP121	Crimping Plier Set TT1 121 Pieces
5/6	TTDTD34	Tap and Die Set TT2 34 Pieces
6/6	TTPS09	General Tool Set BP TT4 9 Pieces
1/3	TT1435	1/4" Socket Set 6 pt TT1 35 Pieces
1/3	TT3819	3/8" Socket Set 6 pt TT1 19 Pieces
1/3	TT1218	1/2" Socket Set 12 pt TT1 17 Pieces
1/3	TT1211	1/2" Socket Set 12 pt TT1 11 Pieces
2/3	TT03	Storage Tray TT1 4 Compartments
2/3	TT04	Storage Tray TT1 6 Compartments
2/3	TTD00	Storage Tray TT2 4 Compartments
1/7	TTD01	Storage Tray TT2 8 Compartments
1/7	TTD02	Storage Tray TT2 16 Compartments
1/7	TTX03	Storage Tray TTX4 8 Compartments
2/7	TT1236	Combination Spanner Set TT1 12 Pieces
2/7	TT6208	Double Open Ended Spanner Set TT1 8 Pieces
2/7	TTHEX7	T-Handle Ball Point Hex Key Set TT1 7 Pieces
2/7	TTTX7	T-Handle TX/TPX Key Set TT1 7 Pieces
2/7	TTX2032	Combination Spanner Set TTX4 7 Pieces
3/7	TTDB28	Drill Bit Set 1.0-13.0 mm TT2 28 Pieces
3/7	TT00	Storage Tray With Tool Holder TT1
3/7	TTHR81	Rivet Gun Set TT1 81 Pieces
3/7	TTTM08	Inspection Set TT1 8 Pieces
3/7	TTXF05	Hand File Set TTX4 5 Pieces
4/7	TTMD74	Ratcheting Screwdriver Bit Set TT1 74 Pieces
4/7	TT917N	Screwdriver Set Mixed TT1 7 Pieces
4/7	TT917TXN	Screwdriver Set TX & TPX TT1 7 Pieces
4/7	TTHT28	Ball Point Hex & TX Key Set TT1 28 Pieces
4/7	TTX918N	Screwdriver Set Flat & PH TTX4 8 Pieces

Item ID: **TCMM569EV**



## Benefits of a well organised tool solution

**INCREASED EFFICIENCY** No more time wasted searching for tools and a more streamlined workflow reduces the total time needed to get the job done.

**IMPROVED QUALITY** Always having the right tool at hand prevents material damage (e.g. deformed screws and bolts).

**REDUCED COSTS** With our tool control system you don't have to waste money on tools you don't need and will lose less tools resulting in lower replacement costs.

**IMPROVED SAFETY** With a well organised tool kit it is easy to spot if any tool is missing. It ensures that no tool is left behind that can cause damage to machinery or injuries to personnel.

**SUSTAINABILITY** One of the most important reasons to get organised is to minimize the amount of lost tools that you have to replace. That is sustainability in a nutshell.



## TT Series | Tool Kits

TT  
SERIES**37" PRO CABINET TT TOOL KIT 622 PIECES**

- A complete tool kit covering the requirements of most users
- All the tools are laid out in individual tool modules using the TengTools Tool Control system
- Easy to see if any tools have been mislaid or lost helping to prevent leaving them with the work piece
- Supplied in a red TengTools 37" 7 drawer roller cabinet
- A comprehensive selection of tools using 6 of the available 7 drawers ensuring that space is still available to add to the kit if needed

- 7 Drawer
- 37" Wide Cabinet
- Heavy Gauge Steel
- 5-Step Rust Protection
- 5" Castor Wheels with Brakes
- 3 Step Ball Bearing Slides
- Comfort Grip Handle
- Combination Lock

622 Pieces  138 kg

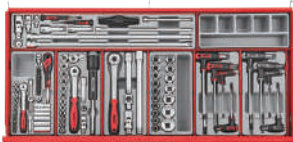

Drawer 1/7



Drawer 2/7

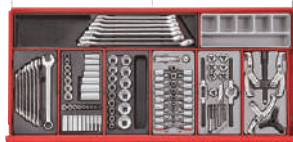

Drawer 3/7



Drawer 4/7

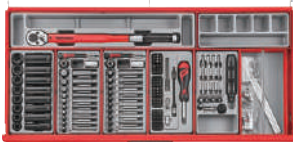

Drawer 5/7



Drawer 6/7



Drawer 7/7

Drawer	Item ID	Description
Storage	TCW207N	37" PRO Cabinet 7 Drawers Red
	TC-TB03	Work Top for 37" Cabinet
1/7	TTXEXT13	Extension Bars Set TTX4 13 Pieces
1/7	TT1435	1/4" Socket Set 6 pt TT1 35 Pieces
1/7	TT3819	3/8" Socket Set 6 pt TT1 19 Pieces
1/7	TT1217	1/2" Socket Set 12 pt TT1 17 Pieces
1/7	TT1205	1/2" Ratchet & Accessories Set TT1 5 Pieces
1/7	TTHEX7	T-Handle Ball Point Hex Key Set TT1 7 Pieces
1/7	TTTX7	T-Handle TX/TPX Key Set TT1 7 Pieces
1/7	TTZ01	Storage Tray TTX2 6 Compartments
2/7	TTX2032	Combination Spanner Set TTX4 7 Pieces
2/7	TT1236	Combination Spanner Set TT1 12 Pieces
2/7	TTSN11	Extractor & Nut Splitter Set TT1 11 Pieces
2/7	TTOS16	Oil Service Set TT1 16 Pieces
2/7	TTM116	Mini Pliers & Screwdriver Set TT1 16 Pieces
2/7	TT474-7	Circlip Plier Set 19-60 mm TT1 4 Pieces
2/7	TT440	Plier Set Vinyl Grip TT1 4 Pieces
2/7	TTZVG03	Power Grip Plier Set TTX2 3 Pieces
3/7	TTX2640	Combination Spanner Set AF TTX4 7 Pieces
3/7	TT3592	Combination Spanner Set AF TT1 8 Pieces
3/7	TTAF32	1/4" & 3/8" Socket Set AF 6 pt TT1 32 Pieces
3/7	TT1215AF	1/2" Socket Set 12 pt AF TT1 15 Pieces
3/7	TTTX30	3/8" TX Bit Socket Set TT1 30 Pieces
3/7	TTTD17	Tap and Die Set TT1 17 Pieces

Drawer	Item ID	Description
3/7	TT804	Puller Set TT1 4 Pieces
3/7	TTZ01	Storage Tray TTX2 6 Compartments
4/7	TTX918N	Screwdriver Set Flat & PH TTX4 8 Pieces
4/7	TTPS09	General Tool Set BP TT4 9 Pieces
4/7	TT917N	Screwdriver Set Mixed TT1 7 Pieces
4/7	TT917TXN	Screwdriver Set TX & TPX TT1 7 Pieces
4/7	TTZ01	Storage Tray TTX2 6 Compartments
5/7	TTX1292	1/2" Torque Wrench 40-210 Nm TTX4
5/7	TT9116N	1/2" Impact Socket Set ANSI TT1 16 Pieces
5/7	TTHEX23	1/2" Hex Bit Socket Set TT1 23 Pieces
5/7	TTALU	Clip Rail Set TT1 32 Pieces
5/7	TTTX23	1/2" TX Bit Socket Set TT1 23 Pieces
5/7	TTID20	1/2" Impact Driver Set TT1 20 Pieces
5/7	TTMD74	Ratcheting Screwdriver Bit Set TT1 74 Pieces
5/7	TTZ01	Storage Tray TTX2 6 Compartments
6/7	TTX6311	Double Ring Spanner Set TTX4 11 Pieces
6/7	TTXPB3	Pry Bar Set Roll/Heel TTX4 3 Pieces
6/7	TTXMB02	Plier & Wrench Set TTX4 2 Pieces
6/7	TTNR81	Nutsert Gun Set TT1 81 Pieces
6/7	TTPC09	Punch & Chisel Set TT1 9 Pieces
6/7	TTZ01	Storage Tray TTX2 6 Compartments

Item ID: **TCMM622N**

## TT Series | Tool Kits

TT  
SERIES



### 53" PRO CABINET TT TOOL KIT 569 PIECES

- A complete tool kit covering the requirements of most users
- All the tools are laid out in individual tool modules using the TengTools Tool Control system
- Easy to see if any tools have been mislaid or lost helping to prevent leaving them with the work piece
- Supplied in a red TengTools 53" 9 drawer roller cabinet
- A comprehensive selection of tools using 8 of the available 9 drawers ensuring that space is still available to add to the kit if needed

- 9 Drawer
- 53" Wide Cabinet
- Heavy Gauge Steel
- 5-Step Rust Protection
- 5" Castor Wheels with Brakes
- 3 Step Ball Bearing Slides
- Comfort Grip Handle
- Combination Lock

569 Pieces 138 kg



Drawer 1/9



Drawer 2/9

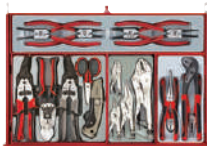

Drawer 3/9



Drawer 4/9



Drawer 5/9



Drawer 6/9



Drawer 7/9



Drawer 8/9



Drawer 9/9

Drawer	Item ID	Description
Storage	TCW809N	53" PRO Cabinet 9 Drawers Red
2/9	TTXEXT13	Extension Bars Set TTX4 13 Pieces
2/9	TT1435	1/4" Socket Set 6 pt TT1 35 Pieces
2/9	TT3819	3/8" Socket Set 6 pt TT1 19 Pieces
2/9	TT1205	1/2" Ratchet & Accessories Set TT1 5 Pieces
2/9	TT1217	1/2" Socket Set 12 pt TT1 17 Pieces
3/9	TTX474-9	Circlip Plier Set 40-100 mm TTX4 4 Pieces
3/9	TT440-T	Plier Set TPR Grip TT1 4 Pieces
3/9	TTVG05	Power Grip Plier Set TT1 5 Pieces
3/9	TTDCT05	Cutting Tool Set TT2 5 Pieces
4/9	TTXF05	Hand File Set TTX4 5 Pieces
4/9	TTTTX30	3/8" TX Bit Socket Set TT1 30 Pieces
4/9	TTBS35	1/4" & 3/8" Bit Socket Set TT1 35 Pieces
4/9	TTTXH15	1/2" Hex & TX Bit Socket Set TT1 15 Pieces
4/9	TTRS15	1/2" Ribe & XZN Bit Socket Set TT1 15 Pieces
5/9	TTX2640	Combination Spanner Set AF TTX4 7 Pieces
5/9	TTAF32	1/4" & 3/8" Socket Set AF 6 pt TT1 32 Pieces
5/9	TT1215AF	1/2" Socket Set 12 pt AF TT1 15 Pieces
5/9	TT3592	Combination Spanner Set AF TT1 8 Pieces
5/9	TT3816	3/8" Socket Set 6 pt TT1 16 Pieces

Drawer	Item ID	Description
6/9	TTX918N	Screwdriver Set Flat & PH TTX4 8 Pieces
6/9	TT917N	Screwdriver Set Mixed TT1 7 Pieces
6/9	TT917TXN	Screwdriver Set TX & TPX TT1 7 Pieces
6/9	TTMD74	Ratcheting Screwdriver Bit Set TT1 74 Pieces
6/9	TTDB28	Drill Bit Set 1.0-13.0 mm TT2 28 Pieces
7/9	TTX2032	Combination Spanner Set TTX4 7 Pieces
7/9	TT1236	Combination Spanner Set TT1 12 Pieces
7/9	TT6508R	Ratcheting Spanner Set R TT1 8 Pieces
7/9	TT6208	Double Open Ended Spanner Set TT1 8 Pieces
7/9	TT474-7	Circlip Plier Set 19-60 mm TT1 4 Pieces
8/9	TTX3404	3/4" Ratchet & Accessories Set TTX4 4 Pieces
8/9	TTHT28	Ball Point Hex & TX Key Set TT1 28 Pieces
8/9	TTHEX7	T-Handle Ball Point Hex Key Set TT1 7 Pieces
8/9	TTTX7	T-Handle TX/TPX Key Set TT1 7 Pieces
8/9	TTTTM08	Inspection Set TT1 8 Pieces
9/9	TTX3414	3/4" Socket Set 6 pt TTX4 14 Pieces
9/9	TT9207	1/2" Impact Accessories Set DIN TT1 11 Pieces
9/9	TT9120DN	1/2" Impact Socket Set DIN TT1 20 Pieces
9/9	TTID20	1/2" Impact Driver Set TT1 20 Pieces
9/9	TTBM	Measuring Tool Set TT1 4 Pieces

Item ID: **TCMMIND08**

## TT Series | Tool Kits

TT  
SERIES

## 26" PRO CABINET TT TOOL KIT 546 PIECES

- A complete tool kit covering the requirements of most users
- All the tools are laid out in individual tool modules using the TengTools Tool Control system
- Easy to see if any tools have been mislaid or lost helping to prevent leaving them with the work piece
- Supplied in a red TengTools 26" 8 drawer roller cabinet
- A comprehensive selection of tools using 7 of the available 8 drawers ensuring that space is still available to add to the kit if needed

- 8 Drawer
- 26" Wide Cabinet
- Heavy Gauge Steel
- 5-Step Rust Protection
- 5" Castor Wheels with Brakes
- 3 Step Ball Bearing Slides
- Comfort Grip Handle
- Combination Lock

546 Pieces 84.7 kg



Drawer 1/8



Drawer 2/8



Drawer 3/8



Drawer 4/8



Drawer 5/8

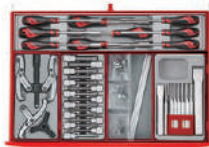

Drawer 6/8



Drawer 7/8



Drawer 8/8

Drawer	Item ID	Description
Storage	TCW808N	26" PRO Cabinet 8 Drawers Red
1/8	TT1205	1/2" Ratchet & Accessories Set TTI 5 Pieces
1/8	TT1217	1/2" Socket Set 12 pt TTI 17 Pieces
1/8	TT1435	1/4" Socket Set 6 pt TTI 35 Pieces
1/8	TT3819	3/8" Socket Set 6 pt TTI 19 Pieces
1/8	TTXEXT13	Extension Bars Set TTX4 13 Pieces
2/8	TT01	Storage Tray TTI 7 Compartments
2/8	TT917N	Screwdriver Set Mixed TTI 7 Pieces
2/8	TT917TXN	Screwdriver Set TX & TPX TTI 7 Pieces
2/8	TTMD74	Ratcheting Screwdriver Bit Set TTI 74 Pieces
2/8	TTXMDTN	Power Through Screwdriver Set TTX4 5 Pieces
3/8	TT01	Storage Tray TTI 7 Compartments
3/8	TTCP121	Crimping Plier Set TTI 121 Pieces
3/8	TTHEX7	T-Handle Ball Point Hex Key Set TTI 7 Pieces
3/8	TTHR81	Rivet Gun Set TTI 81 Pieces
3/8	TTX00	Storage Tray TTX4 1 Compartment
4/8	TTHT28	Ball Point Hex & TX Key Set TTI 28 Pieces





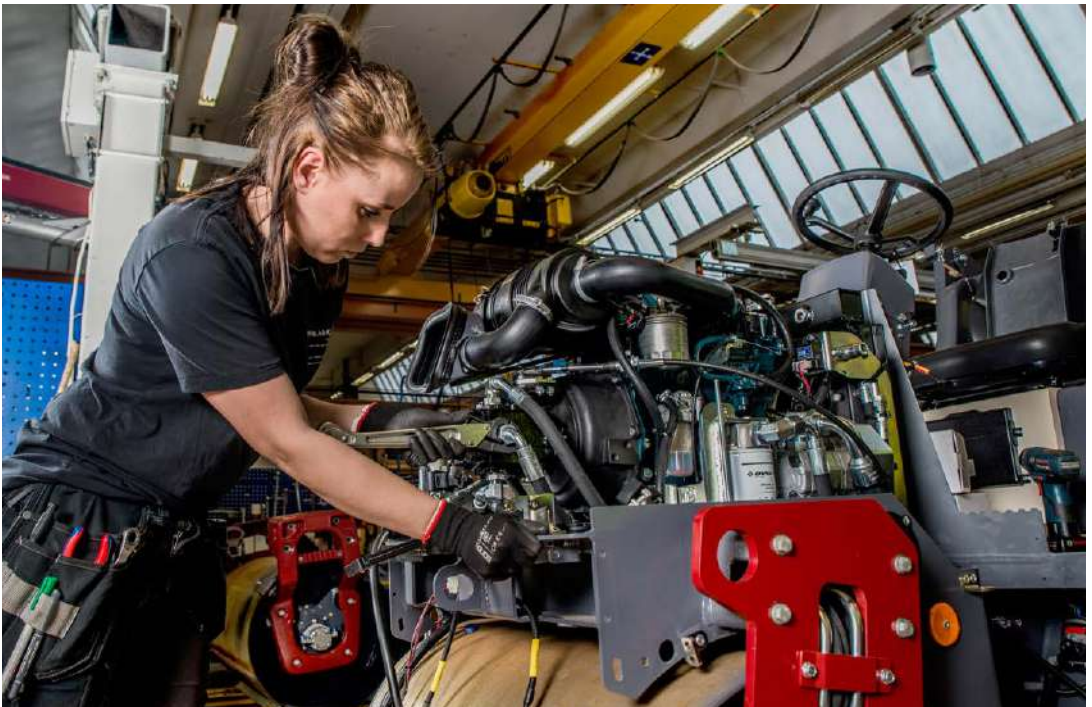



Drawer	Item ID	Description
4/8	TTMD12D	Screwdriver Blade Set Mixed TTI 12 Pieces
4/8	TTNF12	Needle File Set TTI 12 Pieces
4/8	TTSR04	Scraper Set TTI 4 Pieces
4/8	TTXF05	Hand File Set TTX4 5 Pieces
5/8	TT1236	Combination Spanner Set TTI 12 Pieces
5/8	TT440-T	Plier Set TPR Grip TTI 4 Pieces
5/8	TT474-7	Circlip Plier Set 19-60 mm TTI 4 Pieces
5/8	TT6208	Double Open Ended Spanner Set TTI 8 Pieces
5/8	TTX2032	Combination Spanner Set TTX4 7 Pieces
6/8	TT804	Puller Set TTI 4 Pieces
6/8	TTALU	Clip Rail Set TTI 32 Pieces
6/8	TTPC09	Punch & Chisel Set TTI 9 Pieces
6/8	TTTXH15	1/2" Hex & TX Bit Socket Set TTI 15 Pieces
6/8	TTXND	Nut Driver Set TTX4 9 Pieces
7/8	TTPS09	General Tool Set BP TT4 9 Pieces
7/8	TTX01	Storage Tray TTX4 6 Compartments

Item ID: **TCMM546N**



## TT Series | Tool Kits

TT  
SERIES

-  **7 Drawer**
-  **26" Wide Cabinet**
-  **Heavy Gauge Steel**
-  **5-Step Rust Protection**
-  **5" Castor Wheels with Brakes**
-  **3 Step Ball Bearing Slides**
-  **Comfort Grip Handle**
-  **Combination Lock**

  **83.4 kg**

Drawer 1/7



Drawer 2/7



Drawer 3/7



Drawer 4/7



Drawer 5/7



Drawer 6/7



Drawer 7/7

**26" PRO CABINET TT TOOL KIT 491 PIECES**

- A complete tool kit covering the requirements of most users
- All the tools are laid out in individual tool modules using the TengTools Tool Control system
- Easy to see if any tools have been mislaid or lost helping to prevent leaving them with the work piece
- Supplied in a red TengTools 26" 7 drawer roller cabinet
- A comprehensive selection of tools using 6 of the available 7 drawers ensuring that space is still available to add to the kit if needed

Drawer	Item ID	Description
Storage	TCW807N	26" PRO Cabinet 7 Drawers Red
1/7	TTXND	Nut Driver Set TTX4 9 Pieces
1/7	TTI435	1/4" Socket Set 6 pt TTI 35 Pieces
1/7	TT3819	3/8" Socket Set 6 pt TTI 19 Pieces
1/7	TTI236	Combination Spanner Set TTI 12 Pieces
1/7	TT6208	Double Open Ended Spanner Set TTI 8 Pieces
2/7	TTXMDTN	Power Through Screwdriver Set TTX4 5 Pieces
2/7	TTMD74	Ratcheting Screwdriver Bit Set TTI 74 Pieces
2/7	TTHX7	T-Handle Ball Point Hex Key Set TTI 7 Pieces
2/7	TT917N	Screwdriver Set Mixed TTI 7 Pieces
2/7	TT917TXN	Screwdriver Set TX & TPX TTI 7 Pieces
3/7	TTX00	Storage Tray TTX4 1 Compartment
3/7	TT440-T	Plier Set TPR Grip TTI 4 Pieces
3/7	TTPC09	Punch & Chisel Set TTI 9 Pieces
3/7	TTCP121	Crimping Plier Set TTI 121 Pieces
3/7	TTTX7	T-Handle TX/TPX Key Set TTI 7 Pieces
4/7	TTX01	Storage Tray TTX4 6 Compartments
4/7	TTPS09	General Tool Set BP TT4 9 Pieces
5/7	TTXEXT13	Extension Bars Set TTX4 13 Pieces
5/7	TTI217	1/2" Socket Set 12 pt TTI 17 Pieces
5/7	TTI205	1/2" Ratchet & Accessories Set TTI 5 Pieces
5/7	TTTXH15	1/2" Hex & TX Bit Socket Set TTI 15 Pieces
5/7	TTALU	Clip Rail Set TTI 32 Pieces
6/7	TTX2032	Combination Spanner Set TTX4 7 Pieces
6/7	TTHR81	Rivet Gun Set TTI 81 Pieces
6/7	TT804	Puller Set TTI 4 Pieces
6/7	TT474-7	Circlip Plier Set 19-60 mm TTI 4 Pieces
6/7	TT01	Storage Tray TTI 7 Compartments

Item ID: **TCMM491N**

**26" STD CABINET TT TOOL KIT 277 PIECES**

- A complete tool kit covering the requirements of most users
- All the tools are laid out in individual tool modules using the TengTools Tool Control system
- Easy to see if any tools have been mislaid or lost helping to prevent leaving them with the work piece
- Supplied in a red TengTools 26" standard 7 drawer roller cabinet
- A comprehensive selection of tools using 4 of the available 7 drawers ensuring that space is still available to add to the kit if needed



Drawer	Item ID	Description
Storage	TCW707EV	26" STD Cabinet 7 Drawers Red
1/7	TT1435	1/4" Socket Set 6 pt TT1 35 Pieces
1/7	TT3819	3/8" Socket Set 6 pt TT1 19 Pieces
1/7	TT1211	1/2" Socket Set 12 pt TT1 11 Pieces
1/7	TT1218	1/2" Socket Set 12 pt TT1 17 Pieces
1/7	TTXEXT13	Extension Bars Set TTX4 13 Pieces
2/7	TT1236	Combination Spanner Set TT1 12 Pieces
2/7	TT6208	Double Open Ended Spanner Set TT1 8 Pieces
2/7	TTHEX7	T-Handle Ball Point Hex Key Set TT1 7 Pieces
2/7	TTTX7	T-Handle TX/TPX Key Set TT1 7 Pieces
2/7	TTX2032	Combination Spanner Set TTX4 7 Pieces
3/7	TT440	Plier Set Vinyl Grip TT1 4 Pieces
3/7	TTVG05	Power Grip Plier Set TT1 5 Pieces
3/7	TTDCT05	Cutting Tool Set TT2 5 Pieces
3/7	TTX1292	1/2" Torque Wrench 40-210 Nm TTX4
4/7	TTMD74	Ratcheting Screwdriver Bit Set TT1 74 Pieces
4/7	TT917N	Screwdriver Set Mixed TT1 7 Pieces
4/7	TT917TXN	Screwdriver Set TX & TPX TT1 7 Pieces
4/7	TTHT28	Ball Point Hex & TX Key Set TT1 28 Pieces
4/7	TTX918N	Screwdriver Set Flat & PH TTX4 8 Pieces
6/7	TT01	Storage Tray TT1 7 Compartments

- 7 Drawer**
  - 26" Wide Cabinet**
  - Heavy Gauge Steel**
  - 5-Step Rust Protection**
  - 5" Castor Wheels with Brakes**
  - 3 Step Ball Bearing Slides**
  - Key Lock Lock**
- 277 Pieces** **74.3 kg**

Item ID: **TCMM277EV**



Drawer 1/7



Drawer 2/7



Drawer 3/7



Drawer 4/7



Drawer 5/7



Drawer 6/7



Drawer 7/7



# TT Series | Tool Kits

TT SERIES



## 1004 PIECE 8 DRAWER TOOL KIT BLACK

- 1004 piece Work Station tool kit
- A complete tool kit covering the requirements of most types of user
- All the tools are laid out in individual tool modules using the TengTools Tool Control system
- Easy to see if any tools have been mislaid or lost helping to prevent leaving them with the work piece
- Supplied in a black TengTools 37" 8 drawer roller cabinet
- Work Top, Vice + vice shelf, magnetic bits tray and paper holder are included

- 8 Drawer**
- 37" Wide Cabinet**
- Heavy Gauge Steel**
- 5-Step Rust Protection**
- 5" Castor Wheels with Brakes**
- 3 Step Ball Bearing Slides**
- Comfort Grip Handle**
- Combination Lock**

**1004**  
Pieces 138 kg

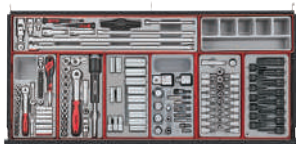

Drawer 1/8

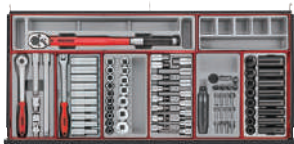

Drawer 2/8

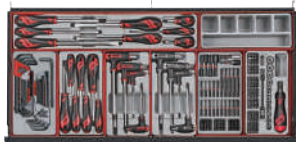

Drawer 3/8

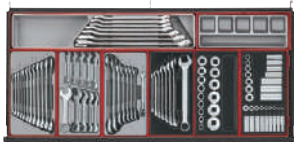

Drawer 4/8

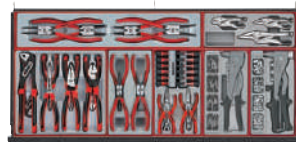

Drawer 5/8



Drawer 6/8

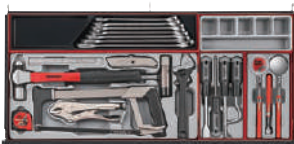

Drawer 7/8

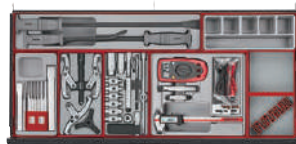

Drawer 8/8

Drawer	Item ID	Description
Storage	580	Magnetic Bits Tray
	TC-TB03	Work Top for 37" Cabinet
	TCATV	Side Shelf for Vice
	TCAV4	4" Work Bench Vice
	TCA01	Paper Roll Holder
	TCW208NBK1	37" PRO Cabinet 8 Drawers Black
1/8	TTZ01	Storage Tray TTX2 6 Compartments
1/8	TTXEXT13	Extension Bars Set TTX4 13 Pieces
1/8	TT1435	1/4" Socket Set 6 pt TT1 35 Pieces
1/8	TT3819	3/8" Socket Set 6 pt TT1 19 Pieces
1/8	TTADP17	Socket Adaptor Set TT1 17 Pieces
1/8	TTTX30	3/8" TX Bit Socket Set TT1 30 Pieces
1/8	TT3816	3/8" Socket Set 6 pt TT1 16 Pieces
1/8	TT9015HX	3/8" & 1/2" Hex Impact Skt Set DIN TT1 15 Pieces
2/8	TTZ01	Storage Tray TTX2 6 Compartments
2/8	TTX1292	1/2" Torque Wrench 40-210 Nm TTX4
2/8	TT1205	1/2" Ratchet & Accessories Set TT1 5 Pieces
2/8	TT1217-6	1/2" Socket Set 6 pt TT1 17 Pieces
2/8	TT9116N	1/2" Impact Socket Set ANSI TT1 16 Pieces
2/8	TTHEX16	1/2" Hex Bit Socket Set TT1 16 Pieces
2/8	TT1211	1/2" Socket Set 12 pt TT1 11 Pieces
2/8	TTID20	1/2" Impact Driver Set TT1 20 Pieces
3/8	TTZ01	Storage Tray TTX2 6 Compartments
3/8	TTX918N	Screwdriver Set Flat & PH TTX4 8 Pieces
3/8	TTTX7	T-Handle TX/TPX Key Set TT1 7 Pieces
3/8	TTHEX7	T-Handle Ball Point Hex Key Set TT1 7 Pieces
3/8	TT917TXN	Screwdriver Set TX & TPX TT1 7 Pieces
3/8	TTBS53	Impact Bit Set TT1 53 Pieces
3/8	TTMDR84	Ratcheting Bits Driver Set TT1 84 Pieces
3/8	TTHT28	Ball Point Hex & TX Key Set TT1 28 Pieces
4/8	TTZ01	Storage Tray TTX2 6 Compartments
4/8	TTX2032	Combination Spanner Set TTX4 7 Pieces
4/8	TT1236	Combination Spanner Set TT1 12 Pieces
4/8	TT6010M	Stubby Combination Spanner Set TT1 10 Pieces
4/8	TT6508R	Ratcheting Spanner Set R TT1 8 Pieces
4/8	TT3592	Combination Spanner Set AF TT1 8 Pieces
4/8	TT1215AF	1/2" Socket Set 12 pt AF TT1 15 Pieces
4/8	TTAF32	1/4" & 3/8" Socket Set AF 6 pt TT1 32 Pieces

Drawer	Item ID	Description
5/8	TTZVG03	Power Grip Plier Set TTX2 3 Pieces
5/8	TTX474-9	Circlip Plier Set 40-100 mm TTX4 4 Pieces
5/8	TTM116	Mini Pliers & Screwdriver Set TT1 16 Pieces
5/8	TT474-7	Circlip Plier Set 19-60 mm TT1 4 Pieces
5/8	TTD441-T	Plier Set TPR Grip TT2 8 Pieces
5/8	TTHR81	Rivet Gun Set TT1 81 Pieces
5/8	TTNR81	Nutsert Gun Set TT1 81 Pieces
6/8	TTZ01	Storage Tray TTX2 6 Compartments
6/8	TTX3892	3/8" Torque Wrench Set TTX4 22 Pieces
6/8	TTD914N	Screwdriver Set Mixed TT2 14 Pieces
6/8	TTMDQ49	Bits Driver Set TT1 49 Pieces
6/8	TTV907N	Insulated Screwdriver Set Mixed TT1 7 Pieces
6/8	TTV440	Insulated Plier Set TT1 4 Pieces
6/8	TTCP121	Crimping Plier Set TT1 121 Pieces
7/8	TTZ01	Storage Tray TTX2 6 Compartments
7/8	TTX2640	Combination Spanner Set AF TTX4 7 Pieces
7/8	TTPS09	General Tool Set BP TT4 9 Pieces
7/8	TTSR04	Scraper Set TT1 4 Pieces
7/8	TTTM03	Inspection Set TT1 3 Pieces
8/8	TTZ01	Storage Tray TTX2 6 Compartments
8/8	TTXPB3A	Pry Bar Set TTX4 3 Pieces
8/8	TTPC09	Punch & Chisel Set TT1 9 Pieces
8/8	TT804	Puller Set TT1 4 Pieces
8/8	TTOS16	Oil Service Set TT1 16 Pieces
8/8	TTDAM	Measuring Tool Set TT2 4 Pieces Discontinued
8/8	TT00	Storage Tray With Tool Holder TT1

Item ID: **TCMM1004NBK1**

## TT Series | Tool Kits

TT  
SERIES**26" PRO CABINET WORKSTATION TT TOOL KIT  
545 PIECES RED**

- A complete tool kit combined with a top plate and back panels to create a work station
- The tools are laid out in individual tool modules using the TengTools Tool Control system
- The most commonly used tools are supplied in wall racks to keep them handy at the work station
- Easy to see if any tools have been mislaid or lost helping to prevent leaving them with the work piece
- Supplied in a red TengTools 26" 7 drawer roller cabinet complete with work top and panels
- A comprehensive selection of tools using 6 of the available 7 drawers ensuring that space is still available to add to the kit if needed

- 7 Drawer
- 26" Wide Cabinet
- Heavy Gauge Steel
- 5-Step Rust Protection
- 5" Castor Wheels with Brakes
- 3 Step Ball Bearing Slides
- Comfort Grip Handle
- Combination Lock

545 Pieces  91.2 kg



Drawer 1/7



Drawer 2/7



Drawer 3/7



Drawer 4/7



Drawer 5/7



Drawer 6/7



Drawer 7/7

Drawer	Item ID	Description
Storage	TCW807N	26" PRO Cabinet 7 Drawers Red
Panel	WRFL05	Hand File Set Wall Rack 5 Pieces
	WRMB04	Plier Set Wall Rack 4 Pieces
	WRMD10N	Screwdriver Set Wall Rack 10 Pieces
	WRSP12	Combination Spanner Set 8-19 mm Wall Rack 12 Pieces
1/7	TTXEXT13	Extension Bars Set TTX4 13 Pieces
1/7	TT1435	1/4" Socket Set 6 pt TT1 35 Pieces
1/7	TT3819	3/8" Socket Set 6 pt TT1 19 Pieces
1/7	TT1218	1/2" Socket Set 12 pt TT1 17 Pieces
1/7	TTTXH15	1/2" Hex & TX Bit Socket Set TT1 15 Pieces
2/7	TTXMDTN	Power Through Screwdriver Set TTX4 5 Pieces
2/7	TTMD74	Ratcheting Screwdriver Bit Set TT1 74 Pieces
2/7	TT917TXN	Screwdriver Set TX & TPX TT1 7 Pieces
2/7	TTHEX7	T-Handle Ball Point Hex Key Set TT1 7 Pieces
2/7	TTTX7	T-Handle TX/TPX Key Set TT1 7 Pieces
3/7	TTXND	Nut Driver Set TTX4 9 Pieces
3/7	TTHR81	Rivet Gun Set TT1 81 Pieces
3/7	TT474-7	Circlip Plier Set 19-60 mm TT1 4 Pieces
3/7	TT804	Puller Set TT1 4 Pieces
3/7	TT01	Storage Tray TT1 7 Compartments
4/7	TTX00	Storage Tray TTX4 1 Compartment
4/7	TTPC09	Punch & Chisel Set TT1 9 Pieces
4/7	TTCP121	Crimping Plier Set TT1 121 Pieces
4/7	TTDTD34	Tap and Die Set TT2 34 Pieces
5/7	TTX2032	Combination Spanner Set TTX4 7 Pieces
5/7	TTDCT05	Cutting Tool Set TT2 5 Pieces
5/7	TTTM08	Inspection Set TT1 8 Pieces
5/7	TTBM	Measuring Tool Set TT1 4 Pieces
6/7	TTX01	Storage Tray TTX4 6 Compartments
6/7	TTPS09E	General Tool Set E TT4 9 Pieces

Item ID: **TCMM545N**



TT Series | Tool Kits

TT SERIES



Drawer 1, 2, 3/6



Drawer 4/6



Drawer 5/6

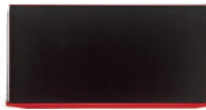

Drawer 6/6

26" STD TOP BOX TT STARTER KIT 20 PIECES

- Mechanics starter kit built up using the TengTools Tool Control system
- Supplied in a red TengTools 26" 6 drawer standard top box with 3 full width drawers and 3 smaller drawers secured with a key lock
- Drop front with the TengTools logo to cover the drawers when the box is closed

- 6 Drawer** 20 Pieces  26 kg
- 26" Wide Box**
- Heavy Gauge Steel**
- 5-Step Rust Protection**
- 3 Step Ball Bearing Slides**
- Key Lock**

Drawer	Item ID	Description
Storage	TC806SV	26" STD Top Box 6 Drawers Red
4/6	TT1236	Combination Spanner Set TT1 12 Pieces
4/6	TT917N	Screwdriver Set Mixed TT1 7 Pieces

Item ID: **TC820SV**

TT SERIES



Drawer 1, 2, 3/6



Drawer 4/6



Drawer 5/6



Drawer 6/6

26" PRO TOP BOX TT TOOL KIT 140 PIECES

- A comprehensive mechanics starter kit built up using the TengTools Tool Control system
- Supplied in a red TengTools 26" 6 drawer top box with 3 full width drawers and 3 smaller drawers secured with a combination lock
- Drop front with the TengTools logo to cover the drawers when the box is closed
- A handy lightweight plastic and aluminium tote tray is included for taking tools to the job in hand

- 6 Drawer** 140 Pieces  42 kg
- 26" Wide Box**
- Heavy Gauge Steel**
- 5-Step Rust Protection**
- 3 Step Ball Bearing Slides**
- Comfort Grip Handle**
- Combination Lock**

Drawer	Item ID	Description
Storage	TC806NF	26" PRO Top Box 6 Drawers Red
4/6	TT1435	1/4" Socket Set 6 pt TT1 35 Pieces
4/6	TT3819	3/8" Socket Set 6 pt TT1 19 Pieces
4/6	TT1217	1/2" Socket Set 12 pt TT1 17 Pieces
4/6	TT1205	1/2" Ratchet & Accessories Set TT1 5 Pieces
5/6	TT1236	Combination Spanner Set TT1 12 Pieces
5/6	TT917N	Screwdriver Set Mixed TT1 7 Pieces
5/6	TT440-T	Plier Set TPR Grip TT1 4 Pieces
5/6	TTALU	Clip Rail Set TT1 32 Pieces
6/6	TTPS09	General Tool Set BP TT4 9 Pieces

Item ID: **TC8140NF**

**26" PRO TOP BOX TT TOOL KIT 140 PIECES**

- A comprehensive mechanics starter kit built up using the TengTools Tool Control system
- Supplied in a red TengTools 26" 6 drawer top box with 3 full width drawers and 3 smaller drawers secured with a combination lock
- Drop front with the TengTools logo to cover the drawers when the box is closed
- A handy lightweight plastic and aluminium tote tray is included for taking tools to the job in hand

Drawer	Item ID	Description
Storage	TC806NGM	26" PRO Top Box 6 Drawers Black Without Logo
4/6	TT1435	1/4" Socket Set 6 pt TT1 35 Pieces
4/6	TT3819	3/8" Socket Set 6 pt TT1 19 Pieces
4/6	TT1217	1/2" Socket Set 12 pt TT1 17 Pieces
4/6	TT1205	1/2" Ratchet & Accessories Set TT1 5 Pieces
5/6	TT1236	Combination Spanner Set TT1 12 Pieces
5/6	TT917N	Screwdriver Set Mixed TT1 7 Pieces
5/6	TT440-T	Plier Set TPR Grip TT1 4 Pieces
5/6	TTALU	Clip Rail Set TT1 32 Pieces
6/6	TTPS09	General Tool Set BP TT4 9 Pieces

Item ID: **TC8140P**

**A Personalised Tool Box Sticker**

This is now available to you through your local stockist. Provide an image that you would like to use and we will customise your tool kit for you. Images need to be supplied as high resolution jpeg, eps, PDF, or ai vector format.



TT SERIES

- 6 Drawer**
- 26" Wide Box**
- Heavy Gauge Steel**
- 5-Step Rust Protection**
- 3 Step Ball Bearing Slides**
- Comfort Grip Handle**
- Combination Lock**

**140** Pieces 42 kg



Drawer 1, 2, 3/6



Drawer 4/6



Drawer 5/6



Drawer 6/6



## TT Series | Tool Kits

## MECCA PRO™

TT  
SERIES113  
Pieces 12.9 kg

## MECCA PRO TC-9 TT TOOL KIT 113 PIECES

- Ideal for technicians
- Supplied in the unique TengTools service case with the tools supplied in 9 TengTools TC1 modules
- Hard wearing flight case style carrying case with a combination lock and secure catches
- Complete with fixed castor wheels and retractable handle for easy carrying

Section	Item ID	Description
1/3	TT1217	1/2" Socket Set 12 pt TTI 17 Pieces
1/3	TT1236	Combination Spanner Set TTI 12 Pieces
1/3	TT440-T	Plier Set TPR Grip TTI 4 Pieces
2/3	TT917N	Screwdriver Set Mixed TTI 7 Pieces
2/3	TT917TXN	Screwdriver Set TX & TPX TTI 7 Pieces
2/3	TTHEX7	T-Handle Ball Point Hex Key Set TTI 7 Pieces
3/3	TT1435	1/4" Socket Set 6 pt TTI 35 Pieces
3/3	TT3819	3/8" Socket Set 6 pt TTI 19 Pieces
3/3	TT1205	1/2" Ratchet & Accessories Set TTI 5 Pieces

Item ID: **SC01**

## MECCA PRO™

TT  
SERIES232  
Pieces 10.3 kg

## MECCA PRO TC-9 TT TOOL KIT 232 PIECES

- Supplied in the unique TengTools service case with the tools supplied in 9 TengTools TC1 modules
- Hard wearing flight case style carrying case with a combination lock and secure catches
- Complete with fixed castor wheels and retractable handle for easy carrying

Section	Item ID	Description
1/3	TT440	Plier Set Vinyl Grip TTI 4 Pieces
1/3	TTM16	Mini Pliers & Screwdriver Set TTI 16 Pieces
1/3	TTCP121	Crimping Plier Set TTI 121 Pieces
2/3	TTTM03	Inspection Set TTI 3 Pieces
2/3	TTNF12	Needle File Set TTI 12 Pieces
2/3	TTDB28	Drill Bit Set 1.0-13.0 mm TT 28 Pieces
3/3	TT6508R	Ratcheting Spanner Set R TTI 8 Pieces
3/3	TTHT28	Ball Point Hex & TX Key Set TTI 28 Pieces
3/3	TTMD12D	Screwdriver Blade Set Mixed TTI 12 Pieces

Item ID: **SC02**

MECCA PRO™

TT SERIES



193 Pieces 10.8 kg



MECCA PRO TC-9 FOAM TOOL KIT 193 PIECES

- Supplied in the unique TengTools service case with the tools supplied in 9 TengTools TCI modules
- Hard wearing flight case style carrying case with a combination lock and secure catches
- Complete with fixed castor wheels and retractable handle for easy carrying

Section	Item ID	Description
1/3	TT440	Plier Set Vinyl Grip TTI 4 Pieces
1/3	TTM16	Mini Pliers & Screwdriver Set TTI 16 Pieces
1/3	TTMD12D	Screwdriver Blade Set Mixed TTI 12 Pieces
2/3	TT917N	Screwdriver Set Mixed TTI 7 Pieces
2/3	TT917XN	Screwdriver Set TX & TPX TTI 7 Pieces
2/3	TTMD74	Ratcheting Screwdriver Bit Set TTI 74 Pieces
3/3	TT1435	1/4" Socket Set 6 pt TTI 35 Pieces
3/3	TTBS35	1/4" & 3/8" Bit Socket Set TTI 35 Pieces
3/3	TTTM03	Inspection Set TTI 3 Pieces

Item ID: **SC03**

MECCA PRO™

TT SERIES



100 Pieces 15.3 kg



MECCA PRO TC-9 TT TOOL KIT 100 PIECES

- Supplied in the unique TengTools service case with the tools supplied in 6 TengTools TCI modules and a TT3 module
- Hard wearing flight case style carrying case with a combination lock and secure catches
- Complete with fixed castor wheels and retractable handle for easy carrying

Section	Item ID	Description
1/3	TT1236	Combination Spanner Set TTI 12 Pieces
1/3	TT917N	Screwdriver Set Mixed TTI 7 Pieces
1/3	TT440-T	Plier Set TPR Grip TTI 4 Pieces
2/3	SCPS01	General Tool Set BP TT3 6 Pieces
3/3	TT1435	1/4" Socket Set 6 pt TTI 35 Pieces
3/3	TT3819	3/8" Socket Set 6 pt TTI 19 Pieces
3/3	TT1218	1/2" Socket Set 12 pt TTI 17 Pieces

Item ID: **SC04**



## TT Series | Tool Kits

## MECCA PRO™

TT  
SERIES100  
Pieces 12.9 kg

## MECCA PRO TC-9 TT TOOL KIT E 100 PIECES

- Supplied in the unique TengTools service case with the tools supplied in 6 TengTools TC1 modules and a TT3 module
- Hard wearing flight case style carrying case with a combination lock and secure catches
- Complete with fixed castor wheels and retractable handle for easy carrying

Section	Item ID	Description
1/3	TT1236	Combination Spanner Set TTI 12 Pieces
1/3	TT917N	Screwdriver Set Mixed TTI 7 Pieces
1/3	TT440-T	Plier Set TPR Grip TTI 4 Pieces
2/3	SCPS01E	General Tool Set E TT3 6 Pieces
3/3	TT1435	1/4" Socket Set 6 pt TTI 35 Pieces
3/3	TT3819	3/8" Socket Set 6 pt TTI 19 Pieces
3/3	TT1218	1/2" Socket Set 12 pt TTI 17 Pieces

Item ID: **SC04E**

## MECCA PRO™

TT  
SERIES114  
Pieces

## MECCA PRO TC-6 TT TOOL KIT 114 PIECE

- Supplied in the unique TengTools service case with the tools supplied in 6 TengTools TC1 modules.
- Hard wearing carrying case with distinctive branding.
- Robust moulded body with built in strength and durability.
- Handle on side make it easy to carry

Section	Item ID	Description
1/2	TT440	Plier Set Vinyl Grip TTI 4 Pieces
1/2	TTHT28	Ball Point Hex & TX Key Set TTI 28 Pieces
1/2	TT01	Storage Tray TTI 7 Compartments
2/2	TT3819	3/8" Socket Set 6 pt TTI 19 Pieces
2/2	TT1236	Combination Spanner Set TTI 12 Pieces
2/2	TTMDQ49	Bits Driver Set TTI 49 Pieces

Item ID: **TC-6T01**

NEW

MECCA PRO™

TT  
SERIES



37  
Pieces

**MECCA PRO TC-6 TT MECHANICS TOOL KIT  
37 PIECES**

- Includes pliers, torque screwdriver, socket set 3/8" drive and screwdrivers
- Insulated tools for live working up to 1,000 volts
- Integrated protective insulation with two colour s to clearly indicate if there is any damage
- All tools are laid in individual TT modules, easy to see if any tool is missing
- Supplied in the unique TengTools service case with the tools supplied in 6 TengTools TT modules
- Nonslip rubber feet to prevent the case from sliding and which protects against scratching
- Secure lock system with click mechanism so you know the top is closed properly
- Hard wearing hinge with metal pin for increased life
- Retractable handle design for comfort and durability

Section	Item ID	Description
1/2	TTV440	Insulated Plier Set TT1 4 Pieces
1/2	TTVSD09	Insulated Torque Screwdriver Blade Set TT1
1/2	TTV3814	Insulated Socket Set 3/8" Drive TT1
2/2	TTDV910N	Insulated Screwdriver Set Mixed TT2
2/2	TT04	Storage Tray TT1 6 Compartments

Item ID: **TC-6T02**



**1 CHOOSE YOUR STORAGE**  
Storages for all needs.



**2 CHOOSE YOUR TOOL SETS**  
Your kit. Your way.



**3 ORGANISE YOUR KIT**  
Optimise your workflow.

# TT SERIES TOOL TRAYS

## A modular system that fits all storages

Our tool sets are available in different sizes (1-4 and X2-X4). These can be combined to fit perfectly into your chosen storage solution, regardless of whether you have a storage that is portable, 26, 37 or 53 inches.

### 1 CHOOSE YOUR STORAGE

Storages for all needs.



### 2 CHOOSE YOUR TOOL SETS

Your kit. Your way.



### 3 ORGANISE YOUR KIT

Optimise your workflow.



## A flexible tool control system with over 240 tool sets

The TT Series offers a space-saving tool control system allowing you to fit more tools in each drawer. With our wide assortment you can build some of the largest tool kits in the market, with over 1000 tools in a 26" wide stack. The tool trays are made of recyclable plastic that is easy to clean and they are ideal for use in dirty or high moisture environments.

**TT  
SERIES**  
SIZE



Portable Service case



26" Top & Middle box drawer



26" cabinet drawer



37" cabinet drawer



1

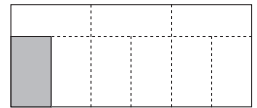
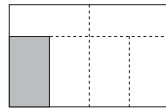
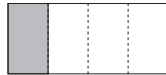
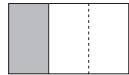

2

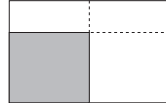

3

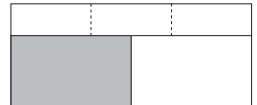
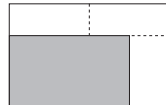
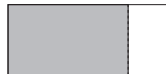
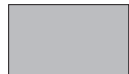

4

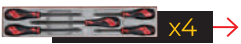
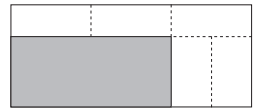
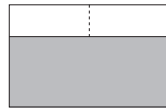
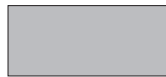
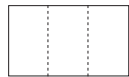

x4

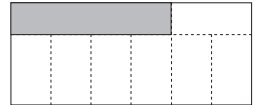
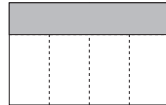
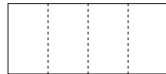
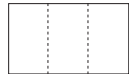

x2

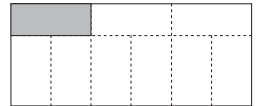
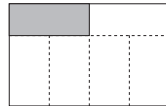
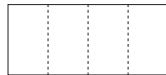
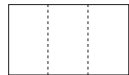

## TT Series | Tool Trays

### STORAGE TRAYS

TT  
SERIES



#### CLIP RAIL SET TTI 32 PIECES

- Includes 2 clip rails and clips for 1/4", 3/8" and 1/2" drive sockets
- A protective mat is included in the bottom of the tray
- Removable lid and dove tail joints
- Organised in a tool tray module size 1 (TTI)

2 x 260mm aluminium rails, 10 x 1/4" drive socket clips,  
10 x 3/8" drive socket clips, 10 x 1/2" drive socket clips

Item ID: **TTALU**

TT  
SERIES



#### STORAGE TRAY TTI WITH TOOL HOLDER

- Includes plastic clips for holding spanners or screwdrivers
- A protective mat is included in the bottom of the tray
- Removable lid and dove tail joints
- Organised in a tool tray module size 1 (TTI)

Item ID: **TT00**

TT  
SERIES



#### STORAGE TRAY TTI 7 COMPARTMENTS

- Storage module with 7 compartments
- Ideal for storing small components and consumables
- Removable lid and dove tail joints
- Organised in a tool tray module size 1 (TTI)

Item ID: **TT01**

TT  
SERIES



#### STORAGE TRAY TTI 2 COMPARTMENTS

- Storage module with 2 compartments
- Ideal for storing small components and consumables
- Removable lid and dove tail joints
- Organised in a tool tray module size 1 (TTI)

Item ID: **TT02**

TT  
SERIES



#### STORAGE TRAY TTI 4 COMPARTMENTS

- Storage module with 4 compartments
- Ideal for storing small components and consumables
- Removable lid and dove tail joints
- Organised in a tool tray module size 1 (TTI)

Item ID: **TT03**

TT  
SERIES



#### STORAGE TRAY TTI 6 COMPARTMENTS

- Storage module with 6 compartments
- Ideal for storing small components and consumables
- Removable lid and dove tail joints
- Organised in a tool tray module size 1 (TTI)

Item ID: **TT04**



**STORAGE TRAY TTI FOR TJ SETS**

- Empty module for holding 4x TJ sets
- Removable lid and dove tail joints
- Organised in a tool tray module size 1 (TT1)

Item ID: **TTTJ04**



**STORAGE TRAY TT2 16 COMPARTMENTS**

- Storage module with 16 compartments
- Ideal for storing small components and consumables
- Removable lid and dove tail joints
- Organised in a tool tray module size 2 (TT2)

Item ID: **TTD02**



**STORAGE TRAY TT2 4 COMPARTMENTS**

- Storage module with 4 compartments
- Ideal for storing small components and consumables
- Removable lid and dove tail joints
- Organised in a tool tray module size 2 (TT2)

Item ID: **TTD00**



**STORAGE TRAY TTX4 1 COMPARTMENT**

- Storage module with 1 compartment
- Ideal for storing additional tools, components and consumables
- Protective mat is included in the bottom of the tray
- Organised in a tool tray module size X4 (TTX4)

Item ID: **TTX00**



**STORAGE TRAY TT2 8 COMPARTMENTS**

- Storage module with 8 compartments
- Ideal for storing small components and consumables
- Removable lid and dove tail joints
- Organised in a tool tray module size 2 (TT2)

Item ID: **TTD01**



**STORAGE TRAY TTX4 6 COMPARTMENTS**

- Storage module with 6 compartments
- Ideal for storing additional tools, components and consumables
- Organised in a tool tray module size X4 (TTX4)

Item ID: **TTX01**

## TT Series | Tool Trays



### STORAGE TRAY TTX4 4 COMPARTMENTS

- Storage module with 4 compartments
- Ideal for storing additional tools, components and consumables
- Organised in a tool tray module size X4 (TTX4)

Item ID: **TTX02**



### STORAGE TRAY TTX4 8 COMPARTMENTS

- Storage module with 8 compartments
- Ideal for storing additional tools, components and consumables
- Organised in a tool tray module size X4 (TTX4)

Item ID: **TTX03**



### STORAGE TRAY TTX2 6 COMPARTMENTS

- Storage module with 6 compartments
- Ideal for storing small components and consumables
- Organised in a tool tray module size X2 (TTX2)

Item ID: **TTZ01**

## GENERAL TOOL KITS



### GENERAL TOOL SET BP TT4 9 PIECES 9 Pieces

- A selection of tools to compliment any tool kit
- Includes measuring, striking and cutting tools as well as an adjustable wrench and power grip pliers
- Organised in a tool tray module size 4 (TT4)

#### General Tools:

6" adjustable wrench, 10" adjustable wrench,  
10" power grip plier, utility knife,  
12" hack saw, soft face hammer, 3 meter tape measure,  
200mm steel rule, 24oz (675g) ball pein hammer

Item ID: **TTPS09**



### GENERAL TOOL SET E TT4 9 PIECES 9 Pieces

- A selection of tools to compliment any tool kit
- Includes measuring, striking and cutting tools as well as an adjustable wrench and power grip pliers
- Organised in a tool tray module size 4 (TT4)

#### General Tools:

6" adjustable wrench, 10" adjustable wrench,  
10" power grip plier, utility knife,  
12" hack saw, soft face hammer, 3 meter measuring tape,  
200mm steel rule, 800g engineers hammer

Item ID: **TTPS09E**



TT  
SERIES



**GENERAL TOOL SET BP TT3 6 PIECES** 6 Pieces

- Especially designed for use in the TengTools portable service cases
- A set of general hand tools to compliment the other sets in a tool kit

General Tools:

Measuring tape, hacksaw frame, utility knife, power grip plier, adjustable wrench, ball pein hammer

Item ID: **SCPS01**



TT  
SERIES



**GENERAL TOOL SET E TT3 6 PIECES** 6 Pieces

- Especially designed for use in the TengTools portable service cases
- A set of general hand tools to compliment the other sets in a tool kit

General Tools:

Measuring tape, hacksaw frame, utility knife, power grip plier, adjustable wrench, engineers hammer

Item ID: **SCPS01E**

**SOCKET SETS**



TT  
SERIES



35 Pieces

1/4"

mm

**1/4" SOCKET SET 6 PT TTI 35 PIECES**

- Regular and deep 6 point single hexagon sockets
- Chrome vanadium satin finish sockets
- Designed and manufactured to DIN and ISO standards
- Organised in a tool tray module size 1 (TT1)

72 Teeth ratchet, Universal Joint, 6" spinner handle

Coupler adaptor, 2" & 4" Extension bars, 3/8" F x 1/4" M T-bar adaptor

6 point sockets:

○	Reg mm:	4	5	5.5	6	7	8	9
		10	11	12	13			
○	Deep mm:	6	7	8	10	12	13	
	1/4" Hex bits:	⊖	4, 5.5	⊕	TPX10, TPX15, TPX20	⊕	5, 6	
		⊕	PH1, PH2	⊕	PZ1, PZ2			

Item ID: **TT1435**



TT Series | Tool Trays



TT SERIES  
1

35 Pieces 1/4" mm

1/4" SOCKET SET 12 PT TTI 35 PIECES

- Regular and deep 12 point bi-hexagon sockets
- Chrome vanadium satin finish sockets
- Designed and manufactured to DIN and ISO standards
- Organised in a tool tray module size 1 (TTI)

72 Teeth ratchet, Universal Joint, 6" spinner handle	
Coupler adaptor, 2" & 4" Extension bars, 3/8" F x 1/4" M T-bar adaptor	
12 point sockets:	
Reg mm:	4 5 5.5 6 7 8 9 10 11 12 13
Deep mm:	6 7 8 10 12 13
1/4" Hex bits:	⊖ 4, 5.5   ⊕ TPX10, TPX15, TPX20   ⊗ 5, 6 ⊕ PH1, PH2   ⊕ PZ1, PZ2

Item ID: TTI43512



TT SERIES  
1

32 Pieces 1/4" 3/8" AF

1/4" & 3/8" SOCKET SET AF 6 PT TTI

- Regular and deep 6 point single hexagon sockets
- Chrome vanadium satin finish sockets
- Designed and manufactured to DIN3120/3124 and ISO2725
- Organised in a tool tray module size 1 (TTI)

3/8" Drive 6 point sockets:	
Reg AF:	3/8 7/16 1/2 9/16 5/8 11/16 3/4
Deep AF:	3/8 7/16 1/2 9/16 5/8 11/16 3/4
1/4" Drive 6 point sockets:	
Reg AF:	3/16 7/32 1/4 9/32 5/16 11/32 3/8 7/16 1/2
Deep AF:	3/16 7/32 1/4 9/32 5/16 11/32 3/8 7/16 1/2

Item ID: TTAF32



TT SERIES  
1

32 Pieces 1/4" 3/8" AF

1/4" & 3/8" SOCKET SET 12 PT AF TTI

- Regular and deep 12 point bi-hexagon sockets
- Chrome vanadium satin finish sockets
- Designed and manufactured to DIN3120/3124 and ISO2725
- Organised in a tool tray module size 1 (TTI)

3/8" Drive 12 point sockets:	
Reg AF:	3/8 7/16 1/2 9/16 5/8 11/16 3/4
Deep AF:	3/8 7/16 1/2 9/16 5/8 11/16 3/4
1/4" Drive 12 point sockets:	
Reg AF:	3/16 7/32 1/4 9/32 5/16 11/32 3/8 7/16 1/2
Deep AF:	3/16 7/32 1/4 9/32 5/16 11/32 3/8 7/16 1/2

Item ID: TTAF3212



TT SERIES  
1

48 Pieces 1/4" mm

1/4" SOCKET & BITS SET TTI 48 PIECES

- Gearless palm ratchet, 3" extension bar
- 1/4" drive regular 6 point sockets 5-13mm
- A selection of 25mm & 89mm long bits
- Organised in a tool tray module size 1 (TTI)

Gearless palm ratchet, 3" extension bar	
6 point sockets:	
Reg mm:	5 5.5 6 7 8 9 10 11 11 12 13
1/4" Hex bits:	⊖ 3.5, 5.5, 8   ⊕ PZ1, PZ2, PZ3   ⊗ 2, 3, 4, 5, 6, 8 Length 25mm   ⊕ PH1, PH2, PH3   ⊕ TPX20, TPX25, TPX30 ⊕ TX10, TX15, TX20, TX25, TX30, TX40   ⊕ ROBI, 2, 3
1/4" Hex bits:	⊖ 3, 4   ⊕ PH1, PH2   ⊕ PZ1, PZ2 Length 89mm   ⊕ TX10, TX20, TX25

Item ID: TTI448



TT SERIES



19 Pieces 3/8" mm

### 3/8" SOCKET SET 6 PT TTI 19 PIECES

- Regular 6 point single hexagon sockets
- Chrome vanadium satin finish sockets
- Designed and manufactured to DIN and ISO standards
- Organised in a tool tray module size 1 (TTI)

72 Teeth ratchet, Universal Joint, 3" Wobble extension bar, 10" Spinner handle

Coupler adaptor, 1/2" F x 3/8" M T-bar adaptor

Regular 6 point sockets:

mm:	8	9	10	11	12	13	14	15	16
	17	18	19	22					

Item ID: **TT3819**



TT SERIES



19 Pieces 3/8" mm

### 3/8" SOCKET SET 12 PT TTI 19 PIECES

- Regular 12 point bi-hexagon sockets
- Chrome vanadium satin finish sockets
- Designed and manufactured to DIN and ISO standards
- Organised in a tool tray module size 1 (TTI)

72 Teeth ratchet, Universal Joint, 3" Wobble extension bar, 10" Spinner handle

Coupler adaptor, 1/2" F x 3/8" M T-bar adaptor

Regular 12 point sockets:

mm:	8	9	10	11	12	13	14	15	16
	17	18	19	22					

Item ID: **TT381912**



TT SERIES



16 Pieces 3/8" mm

### 3/8" SOCKET SET 6 PT TTI 16 PIECES

- Deep 6 point single hexagon sockets
- Chrome vanadium satin finish sockets
- Designed and manufactured to DIN3120/3124 and ISO2725
- Organised in a tool tray module size 1 (TTI)

Deep 6 point sockets:

mm:	7	8	9	10	11	12	13	14	15
	16	17	18	19	20	21	22		

Item ID: **TT3816**



TT SERIES



16 Pieces 3/8" mm

### 3/8" SOCKET SET 12 PT TTI 16 PIECES

- Deep 12 point bi-hexagon sockets
- Chrome vanadium satin finish sockets
- Designed and manufactured to DIN3120/3124 and ISO2725
- Organised in a tool tray module size 1 (TTI)

Deep 12 point sockets:

mm:	7	8	9	10	11	12	13	14	15
	16	17	18	19	20	21	22		

Item ID: **TT381612**

## TT Series | Tool Trays



30 Pieces 1/4" 3/8"

### 3/8" TX BIT SOCKET SET TTI 30 PIECES

- Chrome vanadium satin finish sockets
- Designed and manufactured to DIN and ISO standards
- Organised in a tool tray module size 1 (TTI)

3" Extension bar, 3/8"F x 1/4"M adaptor

3/8" Drive bit sockets:

	TX:	10	15	20	25	27	30	40	45	50
--	-----	----	----	----	----	----	----	----	----	----

	TPX:	10	15	20	25	27	30	40	45	50
--	------	----	----	----	----	----	----	----	----	----

	TX-E:	E10	E12	E14	E16	E18
--	-------	-----	-----	-----	-----	-----

1/4" Drive bit sockets:

	TX-E:	E4	E5	E6	E7	E8
--	-------	----	----	----	----	----

Item ID: **TTTX30**



35 Pieces 1/4" 3/8"

### 1/4" & 3/8" BIT SOCKET SET TTI 35 PIECES

- Includes all the most commonly used screwdriver, hex and TX bits
- Chrome vanadium satin finish sockets
- Organised in a tool tray module size 1 (TTI)

3/8"F x 1/4"M adaptor, 1/4"F x 3/8"M adaptor

1/4" Drive bit sockets:

	TX:	10	15	20	25	27	30	40
--	-----	----	----	----	----	----	----	----

	mm:	4	4.5	7
--	-----	---	-----	---

	PH:	0	1	2	3
--	-----	---	---	---	---

	PZ:	1	2	3
--	-----	---	---	---

3/8" Drive bit sockets:

	mm:	3	4	5	5.5	6	7	8	10	12
--	-----	---	---	---	-----	---	---	---	----	----

	AF:	1/8	5/32	3/16	7/32	1/4	5/16	3/8
--	-----	-----	------	------	------	-----	------	-----

Item ID: **TTBS35**



5 Pieces 1/2"

### 1/2" RATCHET & ACCESSORIES SET TTI 5 PIECES

- Socket accessory set
- Designed and manufactured to DIN and ISO standards
- Organised in a tool tray module size 1 (TTI)

72 Teeth ratchet, 5" & 10" Extension bars

Universal joint, 3/8"F x 1/2"M T-bar adaptor

Item ID: **TTI205**



11 Pieces 1/2" mm

### 1/2" DEEP SOCKET SET 12 PT TTI 11 PIECES

- Deep 12 point bi-hexagon sockets
- Includes a 10" flex handle with ergonomic grip
- Chrome vanadium satin finish
- Designed and manufactured to DIN and ISO standards
- Organised in a tool tray module size 1 (TTI)

10" Flex handle

Deep 12 point sockets:

	mm:	10	11	12	13	14	15
		16	17	18	19		

Item ID: **TTI211**



TT SERIES



17 Pieces 1/2" mm

**1/2" SOCKET SET 6 PT TTI 17 PIECES**

- 6 point single hexagon sockets
- Chrome vanadium satin finish sockets
- Designed and manufactured to DIN3120/3124 and ISO2725
- Organised in a tool tray module size 1 (TTI)

Regular 6 point sockets:

mm:	10	11	12	13	14	15	16	17	18
	19	20	21	22	24	27	30	32	

Item ID: **TTI217-6**



TT SERIES



17 Pieces 1/2" mm

**1/2" SOCKET SET 12 PT TTI 17 PIECES**

- 12 point bi-hexagon sockets
- Chrome vanadium satin finish sockets
- Designed and manufactured to DIN3120/3124 and ISO2725
- Organised in a tool tray module size 1 (TTI)

Regular 12 point sockets:

mm:	10	11	12	13	14	15	16	17	18
	19	20	21	22	24	27	30	32	

Item ID: **TTI217**



TT SERIES



18 Pieces 1/2" mm

**1/2" SOCKET SET 6 PT TTI 18 PIECES**

- 6 point single hexagon sockets
- Chrome vanadium satin finish sockets
- Designed and manufactured to DIN and ISO standards
- Organised in a tool tray module size 1 (TTI)

72 Teeth ratchet, 2½" & 10" Extension bars

Universal joint, 3/8"F x 1/2"M T-bar adaptor

Regular 6 point sockets:

mm:	10	11	12	13	14	15	16	17	18
	19	22	24						

Item ID: **TTI218-6**



TT SERIES



18 Pieces 1/2" mm

**1/2" SOCKET SET 12 PT TTI 18 PIECES**

- 12 point bi-hexagon sockets
- Chrome vanadium satin finish sockets
- Designed and manufactured to DIN and ISO standards
- Organised in a tool tray module size 1 (TTI)

72 Teeth ratchet, 2½" & 10" Extension bars

Universal joint, 3/8"F x 1/2"M T-bar adaptor

Regular 12 point sockets:

mm:	10	11	12	13	14	15	16	17	18
	19	22	24						

Item ID: **TTI218**

## TT Series | Tool Trays



15 Pieces 1/2" AF

### 1/2" SOCKET SET 12 PT AF TTI 15 PIECES

- 12 point bi-hexagon sockets
- Chrome vanadium satin finish sockets
- Designed and manufactured to DIN3120 and ASME B107.1
- Organised in a tool tray module size 1 (TT1)

Regular 12 point sockets:

	AF:	3/8	7/16	1/2	9/16	5/8	11/16	3/4	13/16	7/8
		15/16	1	1-1/16	1-1/8	1-3/16	1-1/4			

Item ID: **TTI215AF**



16 Pieces 1/2" mm

### 1/2" HEX BIT SOCKET SET TTI 16 PIECES

- Chrome vanadium satin finish sockets
- Designed and manufactured to DIN7422
- Organised in a tool tray module size 1 (TT1)

	Hex bit sockets mm:										
Length 55mm:	5	6	7	8	9	10	12	14	17		
Length 100mm:	5	6	10	12	14	17					
Length 115mm:	8										

Item ID: **TTHEX16**



23 Pieces 1/2" mm

### 1/2" HEX BIT SOCKET SET TTI 23 PIECES

- Chrome vanadium satin finish bit holders included
- Grub screws to retain the bit in place, especially useful when working in difficult to reach places
- Designed and manufactured to DIN 3126 & ISO 1173
- Organised in a tool tray module size 1 (TT1)

10mm Hex bit adaptor, 12mm Hex bit adaptor, 2mm Hex mini screwdriver

	Hex bit sockets mm:										
Length 40mm:	10mm Hex Drive:	5	6	7	8	9	10				
	12mm Hex Drive:	12	14	17	19						
Length 75mm:	10mm Hex Drive:	5	6	7	8	9	10				
	12mm Hex Drive:	12	14	17	19						

Item ID: **TTHEX23**



18 Pieces 1/2" mm

### 1/2" TX BIT SOCKET SET TTI 18 PIECES

- Chrome vanadium satin finish sockets
- Designed and manufactured to DIN and ISO standards
- Organised in a tool tray module size 1 (TT1)

	TX bit sockets:										
Length 55mm:	20	25	27	30	40	45	50	55	60		
Length 110mm:	20	25	27	30	40	45	50	55	60		

Item ID: **TTTX18**



TT SERIES

1			
---	--	--	--

23 Pieces 1/2"

**1/2" TX BIT SOCKET SET TTI 23 PIECES**

- Chrome vanadium satin finish bit holders included
- Grub screws to retain the bit in place, especially useful when working in difficult to reach places
- Designed and manufactured to DIN 3126 & ISO 1173
- Organised in a tool tray module size 1 (TT1)

10mm Hex bit adaptor, 12mm Hex bit adaptor, 2mm Hex mini screwdriver

**TX bit sockets:**

Length 40mm:	10mm Hex Drive:	20	25	27	30	40	45	50	55
	12mm Hex Drive:	60	70						

Length 75mm:	10mm Hex Drive:	20	25	27	30	40	45	50	55
	12mm Hex Drive:	60	70						

Item ID: **TTTX23**



TT SERIES

1			
---	--	--	--

15 Pieces 1/2" mm

**1/2" LONG HEX & TX BIT SOCKET SET TTI**

- 100mm length for easier access in recesses
- Chrome vanadium satin finish sockets
- Designed and manufactured to DIN and ISO standards
- Organised in a tool tray module size 1 (TT1)

**TX bit sockets:**

Length 100mm:	20	25	27	30	40	45	50	55	60
---------------	----	----	----	----	----	----	----	----	----

**Hex bit sockets mm:**

Length 100mm:	5	6	7	8	10	12
---------------	---	---	---	---	----	----

Item ID: **TTTXH15**



TT SERIES

1			
---	--	--	--

15 Pieces 1/2"

**1/2" LONG RIBE & XZN BIT SOCKET SET TTI**

- 100mm length for easier access in recesses
- Chrome vanadium satin finish sockets
- Designed and manufactured to DIN and ISO standards
- Organised in a tool tray module size 1 (TT1)

**Ribe bit sockets:**

Length 100mm:	4	5	6	8	10	11	12	13
---------------	---	---	---	---	----	----	----	----

**XZN bit sockets:**

Length 100mm:	5	6	8	10	12	14	16
---------------	---	---	---	----	----	----	----

Item ID: **TTRS15**



TT SERIES

X4			
----	--	--	--

13 Pieces 1/4" 3/8" 1/2"

**EXTENSION BARS SET TTX4 13 PIECES**

- Includes a selection of long and wobble extension bars
- TengTools T-HD handle included for a more comfortable grip
- Designed and manufactured to DIN and ISO standards
- Organised in a tool tray module size X4 (TTX4)

1/4" Drive	6" & 12" Extension bars, Universal joint
------------	--

3/8" Drive	3" Wobble extension bar, 20" Extension bar, Universal joint, 3/8" F x 1/4" M T-bar adaptor
------------	--

1/2" Drive	3" Wobble extension bar, 20" Extension bar, Universal joint
------------	---

T-handle grip, 2mm & 2.5mm Mini Hex Screwdrivers

Item ID: **TTXEXT13**

TT Series | Tool Trays



TT SERIES  
x4

4 Pieces 3/4"

3/4" RATCHET & ACCESSORIES SET TTX4

- Socket accessory set
- Quick release and twist reverse action for easier use
- Sliding T bar and extension bars also included
- Designed and manufactured to DIN and ISO standards
- Organised in a tool tray module size X4 (TTX4)

Quick release 72 teeth ratchet, 8" and 16" Extension bars

Sliding T-bar

Item ID: TTX3404



TT SERIES  
x4

4 Pieces 3/4"

3/4" RATCHET & ACCESSORIES SET SAFETY LOCK

- Socket accessory set
- With safety locking system to avoid tools being dropped
- Quick release and twist reverse action for easier use
- Sliding T bar and extension bars also included
- Designed and manufactured to DIN and ISO standards
- Organised in a tool tray module size X4 (TTX4)

Quick release 72 teeth ratchet, 8" and 16" Extension bars

Sliding T-bar

Item ID: TTX3404S



TT SERIES  
x4

2 Pieces 3/4"

3/4" RATCHET & ACCESSORIES SET TTX4

- Ratchet with extendable handle 545 to 860mm
- Extension bar 16"
- Designed and manufactured according to DIN3122D
- Organised in a tool tray module size X4 (TTX4)

72 teeth 3/4" Drive Extendable Ratchet

16" Extension bar

Item ID: TTX3402E



TT SERIES  
x4

14 Pieces 3/4" mm

3/4" SOCKET SET 6 PT TTX4 14 PIECES

- Chrome vanadium
- Satin finish for a better grip when handling the sockets
- 6 point single hexagon sockets for a better grip
- Designed and manufactured to DIN3120/3124
- Organised in a tool tray module size X4 (TTX4)

Regular 6 point sockets:

mm:	19	21	22	24	27	30	32	33	34
	36	38	41	46	50				

Item ID: TTX3414



TT  
SERIES  
x4

14  
Pieces 3/4" AF

**3/4" SOCKET SET 12 PT AF TTX4 14 PIECES**

- Chrome vanadium
- Satin finish for a better grip when handling the sockets
- 12 point bi-hexagon sockets
- Designed and manufactured to DIN3120 & ASME B107.1
- Organised in a tool tray module size X4 (TTX4)

Regular 12 point sockets:

	AF:	7/8	15/16	1	1-1/16	1-1/8	1-3/16	1-1/4	1-5/16	1-3/8
		1-7/16	1-1/2	1-5/8	1-3/4	1-7/8				

Item ID: **TTX34AF**



TT  
SERIES  
1

17  
Pieces 1/4" 3/8" 1/2"

**SOCKET ADAPTOR SET TTI 17 PIECES**

- A selection of extension bars and adaptors in one handy set
- A full range of converters and adaptors from 1/4" to 1" drive
- Includes regular, magnetic and quick chuck holders for use with 1/4" hex bits
- Designed and manufactured to DIN standard
- Organised in a tool tray module size 1 (TT1)

1/4" Drive:	1/4" Hex Coupler, Hex bit adaptor, 50mm Hex bit adaptor
3/8" Drive:	1/4" Hex Coupler, Hex bit adaptor, 50mm Hex bit adaptor
1/2" Drive:	50mm Hex bit adaptor
Step Up Adaptors:	1/4"F x 3/8"M      3/8" x 1/2"M 1/2"F x 3/4"F      3/4"M x 1"F
Reducing Adaptors:	3/8"F x 1/4"M      1/2"F x 3/8"M 3/4"F x 1/2"M
50mm & 70mm Magnetic bit holder, 50mm Chuck bit holder with quick release	

Item ID: **TTADP17**



TT  
SERIES  
1

24  
Pieces 1/4" 3/8" mm

**1/4" & 3/8" IMPACT SOCKET SET ANSI TTI**

- Chrome molybdenum for use with power tools
- ANSI standard design for use with power tools with a ball bearing socket retainer
- Organised in a tool tray module size 1 (TT1)

3/8" F x 1/4" M impact adaptor

1/4" Drive Impact 6 point sockets:

	Reg mm:	6	7	8	10	13
--	---------	---	---	---	----	----

3/8" Drive Impact 6 point sockets:

	Reg mm:	8	10	11	12	13	14	16	17	19
--	---------	---	----	----	----	----	----	----	----	----

	Deep mm:	8	10	11	12	13	14	16	17	19
--	----------	---	----	----	----	----	----	----	----	----

Item ID: **TT9024**



TT  
SERIES  
1

11  
Pieces 1/2"

**1/2" IMPACT SOCKET ACCESSORIES SET DIN TTI**

- A selection of extension bars and adaptors
- DIN standard design for use with a retaining pin and ring
- Chrome molybdenum for use with power tools
- Organised in a tool tray module size 1 (TT1)

Impact Adaptors: 3/8" F x 1/2" M, 1/2" F x 3/8" M, 1/2" F x 3/4" M

Universal Joint, 3", 5" & 10" Extension bars

Retaining rings & pins: O92194, O92244, P92320, P92325 x1

Item ID: **TT9207**



## TT Series | Tool Trays



11 Pieces 1/2"

## 1/2" IMPACT SOCKET ACCESSORIES SET ANSI TTI

- A selection of extension bars and adaptors
- For use with ANSI sockets
- Chrome molybdenum for use with power tools
- Organised in a tool tray module size 1 (TTI)

Impact Adaptors: 3/8"F x 1/2"M, 1/2"F x 3/8"M, 1/2"F x 3/4"M

Universal Joint, 3", 5" & 10" Extension bars

Retaining rings & pins: O92194, O92244, P92320, P92325 x1

Item ID: TT9207A



16 Pieces 1/2" mm

## 1/2" IMPACT SOCKET SET ANSI TTI 16 PIECES

- ANSI standard design for use with power tools with a ball bearing socket retainer
- Chrome molybdenum for use with power tools
- Organised in a tool tray module size 1 (TTI)

1/2" Drive Impact 6 point sockets:

	Reg mm:	13	15	16	17	18	19	22	24
	Deep mm:	13	15	16	17	18	19	22	24

Item ID: TT9116N



12 Pieces 1/2" mm

## 1/2" IMPACT SOCKET SET DIN TTI 12 PIECES

- DIN standard design for use with a retaining pin and ring
- Chrome molybdenum for use with power tools
- O-rings & pins included
- Designed and manufactured to DIN3129
- Organised in a tool tray module size 1 (TTI)

Retaining rings & pins: O92244, P92325 x1

1/2" Drive Impact 6 point sockets:

	Reg mm:	19	21	22	24	27	30	32
	Deep mm:	19	21	22	24	27		

Item ID: TT9212



20 Pieces 1/2" mm

## 1/2" IMPACT SOCKET SET DIN TTI 20 PIECES

- DIN standard design for use with a retaining pin and ring
- Chrome molybdenum for use with power tools
- Designed and manufactured to DIN3129
- Organised in a tool tray module size 1 (TTI)

Retaining rings & pins: O92194, O92244, P92320, P92325 x1

1/2" Drive Impact 6 point sockets:

	Reg mm:	13	15	16	17	18	19	22	24
	Deep mm:	13	15	16	17	18	19	22	24

Item ID: TT9120DN



TT SERIES

1		
---	--	--

12 Pieces 1/2"

**1/2" TX IMPACT SOCKET SET DIN TT1**

- Chrome molybdenum for use with power tools
- DIN standard design for use with a retaining pin and ring
- Organised in a tool tray module size 1 (TT1)

1/2" Drive Impact TX bit sockets:

	TX:	10	15	20	25	27	30	40	45
		50	55	60	70				

Item ID: **TT9212TX**



TT SERIES

1		
---	--	--

15 Pieces 3/8" 1/2" mm

**3/8" & 1/2" HEX IMPACT SOCKET SET DIN TT1**

- Chrome molybdenum for use with power tools
- DIN standard design for use with a retaining pin and ring
- Designed and manufactured to DIN3129
- Organised in a tool tray module size 1 (TT1)

3/8" Drive Impact Hex bit sockets:

	mm:	4	5	6	7	8	10	12
--	-----	---	---	---	---	---	----	----

1/2" Drive Impact Hex bit sockets:

	mm:	5	6	8	10	12	14	17	19
--	-----	---	---	---	----	----	----	----	----

Item ID: **TT9015HX**



TT SERIES

1		
---	--	--

8 Pieces 1/2"

**1/2" TORQUE STICKS & WHEEL NUT SET TT1**

- For the correct tightening of wheel nut sockets on cars
- When the correct torque is reached the torque stick socket end stops turning while the drive end springs back with each stroke
- Reduces the risk of sheared wheel nut bolts or distorted rims and brake discs
- Chrome molybdenum wheel nut sockets with protective inserts to avoid damage to wheels
- Organised in a tool tray module size 1 (TT1)

3/8" x 1/2" Torque step up adaptor

1/2" Drive Torque sticks:

Nm:	90	110	120	140
-----	----	-----	-----	-----

1/2" Drive wheel nut sockets:

	mm:	17	19	21
--	-----	----	----	----

Item ID: **TTTS08**



TT SERIES

	2	
--	---	--

16 Pieces 3/4" mm

**3/4" IMPACT SOCKET SET DIN TT2 16 PIECES**

- 7" impact extension bar included for reaching in to recessed wheels, etc
- DIN standard design for use with a retaining pin and ring (included)
- Chrome molybdenum for use with power tools
- Organised in a tool tray module size 2 (TT2)

7" Extension bar

Retaining rings & pins: O95036 x3, P90435 x3

3/4" Drive Impact 6 point sockets:

	Reg mm:	19 (3/4")	24	27 (1-1/16")	30 (1-3/16")	32	33
		34	36	38			

Item ID: **TTD9416**

## TT Series | Tool Trays

TT  
SERIES15  
Pieces 3/4" mm

## 3/4" IMPACT SOCKET SET DIN TTX4 15 PIECES

- DIN standard design for use with a retaining pin and ring
- Chrome molybdenum for use with power tools
- Organised in a tool tray module size X4 (TTX4)

3/4" Drive Impact 6 point sockets:

○	Reg mm:	19 (3/4")	24	27 (1-1/16")	28
		30 (1-3/16")	32	34	36
○	Deep mm:	19 (3/4")	24	27 (1-1/16")	
		30 (1-3/16")	32	33	36

Item ID: TTX9415

TT  
SERIES20  
Pieces 1/2"

## 1/2" IMPACT DRIVER SET TTI 20 PIECES

- Includes a range of impact bits for removing stubborn fastenings
- Organised in a tool tray module size 1 (TTI)

Reversible impact driver, coupler adaptor,  
5/16" Hex x 1/2"M adaptor

5/16" Hex bits: Length 36mm	⊖	6, 8, 10, 12	⊕	PH1, PH2, PH3, PH4
	⊖	4, 5, 6, 8	⊕	TX30, TX40, TX45, TX50, TX55

Item ID: TTID20

TT  
SERIES19  
Pieces 1/4"

## 1/4" IMPACT DRIVER SET TTI 19 PIECES

- Includes a range of impact bits, impact sockets and screw extractors
- A complete set for removing stubborn fastenings
- Organised in a tool tray module size 1 (TTI)

1/4" Drive reversible impact driver, Impact Bit Adaptor,  
1/4" Hex x 1/4"M adaptor

1/4" Drive Impact 6 point sockets:

○	Reg mm:	8	10	13
	Screw Extractors:	1	2	3
	1/4" Hex Impact Bits: Length 50mm	⊖ 3, 4, 5, 6	⊕ TX25, TX30, TX40	⊕ PZ2, PZ3

Item ID: TTID19

## TORQUE TOOLS

TT  
SERIES38  
Pieces 1/4"

## TORQUE SCREWDRIVER SET TTI 38 PIECES

- Includes a 1-5Nm 1/4" drive torque screwdriver
- Accurate to +/- 6% and conforms to ISO6789 for assured accuracy
- Wide range of screwdriver bits and accessories
- Removable lid and dove tail joints
- Organised in a tool tray module size 1 (TTI)

1-5Nm Torque screwdriver, 1/4"M x 1/4"Hex adaptor

1/4" Hex bits: Length 25mm	⊖	3, 4.5, 5.5, 6.5	⊕	PH0, PH1, PH2, PH3
	⊖	2, 3, 4, 5, 6	⊕	PZ0, PZ1, PZ2, PZ3
			⊕	ROB1, 2, 3
			⊕	TX8, TX9, TX10, TX15, TX20, TX25, TX27, TX30, TX40
			⊕	TPX10, TPX15, TPX20, TPX30, TPX40
			⊕	PH2G (x2)

Item ID: TTSD38



TT  
SERIES  
x4

22  
Pieces 3/8"

**3/8" TORQUE WRENCH SET 20-110 NM TTX4**

- Ideal set for automotive technicians
- Equipped with an in-built angular gauge for easier after tightening
- Click type mechanism when the required torque is reached
- Additional ft/lb reference scale (range 15-81 ft/lb)
- Marked to show the correct place where pressure should be applied
- Twist locking facility to ensure the set torque is maintained
- Reversible 24 teeth ratchet (DIN3122) giving 15° increments
- Designed to torque right hand (clockwise) fasteners
- Accurate to +/- 4% conforms to ISO6789 for assured accuracy
- Individually tested and certified at the time of manufacture
- Organised in a tool tray module size X4 (TTX4)

3/8" Drive Torque wrench (20-110Nm, 15-81 ft/lb),  
3" and 5" extension bars, adaptor for 10mm hex bits

10mm Hex Drive TX bits:

TX8, TX10, TX15, TX20, TX25, TX27, TX30, TX40

3/8" Drive Crow Foot Wrenches

10, 11, 12, 13, 14, 15, 16, 17, 18, 19 mm

Item ID: **TTX3892**



TT  
SERIES  
x4

1  
Piece 1/2"

**1/2" TORQUE WRENCH P-SERIES 40-200 NM TTX4**

- Click type mechanism to signal when the required torque is reached
- Simple to adjust and easy to read Nm scale
- Locking button to ensure the set torque is securely maintained
- Compact head for easier use in confined spaces
- Quick release 72 teeth ratchet mechanism with twist reverse (DIN3122)
- Designed to torque right hand (clockwise) fasteners
- Ergonomic bi-material grip for added comfort
- Marked to show the correct place where pressure should be applied
- Hanging facility which can be used together with a fall protection wire
- Accurate to +/- 4% and conforms to ISO6789 for assured accuracy
- Each torque wrench has its own individual certification number
- Organised in a tool tray module size X4 (TTX4)

1/2" Drive P-SERIES Torque wrench (40-200Nm)

Item ID: **TTXP1292**



TT  
SERIES  
x4

1  
Piece 1/2"

**1/2" TORQUE WRENCH 40-210 NM TTX4**

- Equipped with an in-built angular gauge for easier after tightening
- Additional ft/lb reference scale (range 30-150 ft/lb)
- Marked to show the correct place where pressure should be applied
- Twist locking facility to ensure the set torque is maintained
- Reversible 24 teeth ratchet (DIN3122) giving 15° increments
- Designed to torque right hand (clockwise) fasteners
- Accurate to +/- 4% conforms to ISO6789 for assured accuracy
- Individually tested and certified at the time of manufacture
- Organised in a tool tray module size X4 (TTX4)

1/2" Drive Torque wrench (40-210Nm, 30-150 ft/lb)

Item ID: **TTX1292**



TT  
SERIES  
x4

2  
Pieces 1/2" 3/4"

**1/2" TORQUE MULTIPLIER SET TTX4 2 PIECES**

- Includes a 1/2" drive torque wrench giving a range of 40 to 210Nm
- The torque multiplier can be used to multiply the torque at a ratio of 1:3 increasing the potential torque to 630Nm
- For use with 3/4" drive sockets
- Organised in a tool tray module size X4 (TTX4)

1/2" Drive Torque wrench (40-210Nm, 30-150 ft/lb)

1/2" F:3/4" M Torque multiplier (1:3 ratio) and maximum torque capacity 1,500Nm

Item ID: **TTXMP12**

## TT Series | Tool Trays

## SPANNERS &amp; WRENCHES

TT  
SERIES12  
Pieces

mm

## COMBINATION SPANNER SET ANTI SLIP TTI

- Off set at 15° for easier use on flat surfaces
- TengTools hip grip design for contact with the flat side of the fastening
- TengTools anti slip design on the open end to give a much better grip
- Organised in a tool tray module size 1 (TTI)

Combination Spanners:

8, 9, 10, 11, 12, 13, 14, 15, 16, 17, 18, 19 mm



HIP GRIP AND ANTI-SLIP

Item ID: **TT8012**TT  
SERIES10  
Pieces

mm

## STUBBY COMBINATION SPANNER SET TTI

- Short stubby spanners for use in confined spaces
- Off set at 15° for easier use on flat surfaces
- TengTools hip grip design for contact with the flat side of the fastening
- Chrome vanadium satin finish
- Designed and manufactured to DIN3113A
- Organised in a tool tray module size 1 (TTI)

Midget Combination Spanners:

10, 11, 12, 13, 14, 15, 16, 17, 18, 19 mm

Item ID: **TT6010M**TT  
SERIES12  
Pieces

mm

## COMBINATION SPANNER SET TTI 12 PIECES

- Off set at 15° for easier use on flat surfaces
- TengTools hip grip design for contact with the flat side of the fastening
- Chrome vanadium satin finish
- Designed and manufactured to DIN3113A
- Organised in a tool tray module size 1 (TTI)

Combination Spanners:

8, 9, 10, 11, 12, 13, 14, 15, 16, 17, 18, 19 mm

Item ID: **TT1236**TT  
SERIES8  
Pieces

AF

## COMBINATION SPANNER SET AF TTI 8 PIECES

- Off set at 15° for easier use on flat surfaces
- TengTools hip grip design for contact with the flat side of the fastening
- Chrome vanadium satin finish
- Designed and manufactured to ASME B107.100
- Organised in a tool tray module size 1 (TTI)

Combination Spanners:

5/16", 3/8", 7/16", 1/2", 9/16", 5/8", 11/16", 3/4"

Item ID: **TT3592**



TT  
SERIES



**COMBINATION SPANNER SET TTX4 7 PIECES**

- Chrome vanadium, satin finish
- Off set at 15° for easier use on flat surfaces
- TengTools hip grip design for contact with the flat side of the fastening
- Designed and manufactured to DIN3113A
- Organised in a tool tray module size X4 (TTX4)

Combination Spanners:

20, 21, 22, 24, 27, 30, 32 mm

Item ID: **TTX2032**



TT  
SERIES



**LONG COMBINATION SPANNER SET TTX4**

- Extra long for increased torque
- Off set at 15° for easier use on flat surfaces
- TengTools hip grip design for contact with the flat side of the fastening
- Designed and manufactured to DIN3113A
- Organised in a tool tray module size X4 (TTX4)

Long Combination Spanners:

8, 9, 10, 11, 12, 13, 14, 15, 16, 17, 18, 19 mm

Item ID: **TTXLMP12**



TT  
SERIES



**COMBINATION SPANNER SET AF TTX4 7 PIECES**

- Chrome vanadium, satin finish
- Off set at 15° for easier use on flat surfaces
- TengTools hip grip design for contact with the flat side of the fastening
- Designed and manufactured to ASME B107.100
- Organised in a tool tray module size X4 (TTX4)

Combination Spanners:

13/16", 7/8", 15/16", 1", 1-1/16", 1-1/8", 1-1/4"

Item ID: **TTX2640**



TT  
SERIES



**RATCHETING COMBI SPANNER SET R TTI**

- 72 teeth ratchet spanners giving a 5° increment between clicks
- Reversible ratchet mechanism with a flip reverse lever
- TengTools hip grip design on the ring end
- Chrome vanadium satin finish
- Designed and manufactured to DIN ISO 1711-1 and DIN 3113A
- Organised in a tool tray module size 1 (TTI)

Ratchet Spanners with flip reverse switch:

8, 10, 11, 12, 13, 14, 17, 19 mm

Item ID: **TT6508R**

## TT Series | Tool Trays

TT  
SERIES11  
Pieces mm**RATCHETING COMBI SPANNER SET R TTI**

- 72 teeth ratchet spanners giving a 5° increment between clicks
- Reversible ratchet mechanism with hip grip & flip reverse lever
- Chrome vanadium satin finish
- Designed and manufactured to DIN ISO 1711-1 and DIN 3113A
- Organised in a tool tray module size 1 (TT1)

Ratchet Spanners with flip reverse switch:

8, 10, 11, 12, 13, 14, 15, 16, 17, 18, 19 mm

Item ID: **TT6511R**TT  
SERIES8  
Pieces mm**RATCHETING COMBI SPANNER SET RF TTI**

- 72 teeth ratchet spanners giving a 5° increment between clicks
- Flexible head for use at an angle or for reversing the direction of use when ratcheting
- Chrome vanadium satin finish
- Removable lid and dove tail joints
- Organised in a tool tray module size 1 (TT1)

Flexible head Ratchet Spanners:

8, 10, 11, 12, 13, 14, 17, 19 mm

Item ID: **TT6508RF**TT  
SERIES8  
Pieces AF**RATCHETING COMBI SPANNER SET R AF TTI**

- 72 teeth ratchet spanners giving a 5° increment between clicks
- Reversible ratchet mechanism with a flip reverse lever
- Chrome vanadium satin finish
- Manufactured to DIN ISO 1711-1 and ASME B107.100
- Organised in a tool tray module size 1 (TT1)

Ratchet Spanners with flip reverse switch:

5/16", 3/8", 7/16", 1/2", 9/16", 5/8", 11/16", 3/4"

Item ID: **TT6508RAF**TT  
SERIES10  
Pieces mm**STUBBY RATCHETING SPANNER SET RS TTI**

- Short stubby spanners for use in confined spaces.
- 72 teeth ratchet spanners giving a 5° increment between clicks.
- Hip Grip on the ring end, turn spanner over to change direction.
- Chrome vanadium satin finish
- Organised in a tool tray module size 1 (TT1)

Stubby Ratchet Spanners:

10, 11, 12, 13, 14, 15, 16, 17, 18, 19 mm

Item ID: **TT6010MRS**



TT SERIES



8 Pieces

mm

**RATCHETING COMBI SPANNER SET RS TT1**

- 72 teeth ratchet spanners giving a 5° increment between clicks
- Simply turn over to reverse the direction of use when ratcheting
- Chrome vanadium satin finish
- Designed and manufactured to DIN ISO 1711-1 & DIN 3113A
- Organised in a tool tray module size 1 (TT1)

Ratchet Spanners:

8, 10, 11, 12, 13, 14, 17, 19 mm

Item ID: **TT6508RS**



TT SERIES



11 Pieces

mm

**DOUBLE RING SPANNER SET TTX4 11 PIECES**

- Different size at each end to give 22 sizes in total
- Double curved heads offset at 75° for easier use on flat surfaces
- Chrome vanadium satin finish
- TengTools hip grip design for contact with the flat side of the fastening
- Designed and manufactured to DIN838
- Organised in a tool tray module size X4 (TTX4)

Double Ring Spanners:

6x7, 8x9, 10x11, 12x13, 14x15, 16x17, 18x19, 20x22, 21x23, 24x27, 30x32 mm

Item ID: **TTX6311**



TT SERIES



11 Pieces

mm

**RATCHETING COMBI SPANNER SET RS TT1**

- 72 teeth ratchet spanners giving a 5° increment between clicks
- Hip grip on the ring end, turn spanner over to change direction
- Chrome vanadium satin finish
- Designed and manufactured to DIN ISO 1711-1 and DIN 3113A
- Organised in a tool tray module size 1 (TT1)

Ratchet Spanners:

8, 10, 11, 12, 13, 14, 15, 16, 17, 18, 19 mm

Item ID: **TT6511RS**



TT SERIES



7 Pieces

AF

**DOUBLE RING SPANNER SET AF TTX4 7 PIECES**

- Different size at each end to give 12 sizes in total
- Double curved heads offset at 75° for easier use on flat surfaces
- Chrome vanadium satin finish
- TengTools hip grip design for contact with the flat side of the fastening
- Organised in a tool tray module size X4 (TTX4)

Double Ring Spanners:

1/4" x 5/16", 3/8" x 7/16", 7/16" x 1/2", 13/16" x 7/8",  
15/16" x 1-1/16", 1" x 1-1/8", 1-1/8" x 1-1/4"

Item ID: **TTX6707**



## TT Series | Tool Trays

TT  
SERIES**LONG DOUBLE RING SPANNER SET TTX4**

- Different size at each end to give 12 sizes in total
- Extra long, flat design for extra torque
- Chrome vanadium satin finish
- TengTools hip grip design for contact with the flat side of the fastening
- Designed and manufactured to DIN837
- Organised in a tool tray module size X4 (TTX4)

Extra long Double Ring Spanners:

8x10, 11x13, 12x14, 16x18, 17x19, 22x24 mm

Item ID: **TTXFLS06**TT  
SERIES**DOUBLE OPEN ENDED SPANNER SET AF TTX4**

- Different size at each end to give 14 sizes in total
- Chrome vanadium satin finish
- TengTools hip grip design for contact with the flat side of the fastening
- Designed and manufactured to ASME B107.100
- Organised in a tool tray module size X4 (TTX4)

Double Open Ended Spanners:

1/4" x 5/16", 3/8" x 7/16", 1/2" x 9/16", 5/8" x 3/4",  
13/16" x 7/8", 15/16" x 1", 1-1/8" x 1-1/4"Item ID: **TTX6607**TT  
SERIES**DOUBLE OPEN ENDED SPANNER SET TTI**

- Different size at each end to give 16 sizes in total
- Open at each end off set at 15° for easier use
- Chrome vanadium satin finish
- Designed and manufactured to DIN3110
- Organised in a tool tray module size 1 (TTI)

Double Open Ended Spanners:

6x7, 8x9, 10x11, 12x13, 14x15, 16x17, 18x19, 20x22 mm

Item ID: **TT6208**TT  
SERIES**DOUBLE FLEX WRENCH SET TTI 6 PIECES**

- Swivel end wrenches for fast pre-tightening and loosening
- Angle at 90° for added torque when applying the final tightening
- Extra torque for loosening stubborn fastenings
- Chrome vanadium satin finish
- Designed and manufactured to DIN standard
- Organised in a tool tray module size 1 (TTI)

Double Flex Wrenches

8x9, 10x11, 12x13, 14x15, 16x17, 18x19 mm

Item ID: **TT6506**



TT  
SERIES



**QUICK WRENCH SET TTX4 7 PIECES**

- Special design for loosening and tightening pipe and hose couplings
- Ideal for use in confined spaces
- Ring end has a clever design so that it opens up easily to access the nut on the coupling
- Organised in a tool tray module size X4 (TTX4)

Quick Wrenches:

13, 17, 19, 22, 24, 27, 32 mm

Item ID: **TTXQRS07**



TT  
SERIES



**RATCHETING RING SPANNER SET TTI 6 PIECES**

- Fibre reinforced reversible ratchet wrenches
- 18 teeth for extra strength and use in outdoor sites
- Double ended with 25° offset heads
- 12 point ring ends (6x8mm is 6 point)
- Chrome vanadium satin finish with FRP bodies
- Organised in a tool tray module size 1 (TTI)

RORS Wrenches:

6x8, 7x9, 10x13, 12x14, 17x19, 21x22 mm

Item ID: **TTRORS**



TT  
SERIES



**HOOK & PIN WRENCH SET TTI 8 PIECES**

- Includes a range of handles, pin and hook adaptors
- Chrome vanadium satin finish
- To be used for nuts designed and manufactured to DIN1804 & 1816
- Wrench manufactured to DIN1810
- Organised in a tool tray module size 1 (TTI)

Hook & Pin Wrenches

Hook Handles: 3/4" to 2", 1-1/4" to 3", 2" to 4-3/4"

Pin Adaptors: 4, 5, 6 mm

Pins: 6, 8 mm

Item ID: **TTHP08**



TT  
SERIES



**ADJUSTABLE WRENCH SET TTI 4 PIECES**

- Includes an 8" wide jaw adjustable wrench for added versatility
- Designed and manufactured to ISO6787
- Organised in a tool tray module size 1 (TTI)

Adjustable Wrenches

6" (150 mm) Capacity: 24 mm

8" (200 mm) Capacity: 28 mm

10" (250 mm) Capacity: 33 mm

8" (200 mm) Wide Jaw Capacity: 38 mm

Item ID: **TTADJ04**

## TT Series | Tool Trays

## SCREWDRIVERS

TT  
SERIES

## SCREWDRIVER SET MIXED TTI 7 PIECES

- TT-MV PLUS steel alloy for greater strength and material flexibility
- Ergonomically designed bi-material handle for easy use with higher torque
- Hanging hole in the handle for use as a T handle or with a fall protection wire
- The handle is moulded around the blade to give a higher torque capacity
- Organised in a tool tray module size 1 (TT1)

Screwdrivers:

	mm:	3 x 75	5.5 x 75	6.5 x 100
	mm:	PH0 x 75	PH1 x 75	PH2 x 100
	mm:	PZ2 x 100		

Item ID: **TT917N**TT  
SERIES

## SCREWDRIVER SET MIXED TT2 14 PIECES

- TT-MV PLUS steel alloy for greater strength and material flexibility
- Ergonomically designed bi-material handle for easy use with higher torque
- Hanging hole in the handle for use as a T handle or with a fall protection wire
- The handle is moulded around the blade to give a higher torque capacity
- Organised in a tool tray module size 2 (TT2)

Screwdrivers:

	mm:	3 x 75	3.5 x 100	5.5 x 75	5.5 x 125
		6.5 x 38	6.5 x 100		
	mm:	PH0 x 75	PH1 x 75	PH2 x 38	PH2 x 100
	mm:	PZ0 x 75	PZ1 x 75	PZ2 x 38	PZ2 x 100

Item ID: **TTD914N**TT  
SERIES

## SCREWDRIVER SET FLAT &amp; PH TTX4 8 PIECES

- TT-MV PLUS steel alloy for greater strength and material flexibility
- Ergonomically designed bi-material handle for easy use with higher torque
- Hanging hole in the handle for use as a T handle or with a fall protection wire
- The handle is moulded around the blade to give a higher torque capacity
- Organised in a tool tray module size X4 (TTX4)

Screwdrivers:

	mm:	6.5 x 38	3 x 100	6.5 x 100	10 x 200
		5.5 x 150	8 x 150		
	mm:	PH2 x 38	PH3 x 150		

Item ID: **TTX918N**



TT SERIES



**SCREWDRIVER SET TX & TPX TTI 7 PIECES**

- TT-MV PLUS steel alloy for greater strength and material flexibility
- Ergonomically designed bi-material handle for easy use with higher torque
- Hanging hole in the handle for use as a T handle or with a fall protection wire
- The handle is moulded around the blade to give a higher torque capacity
- Organised in a tool tray module size 1 (TTI)

Screwdrivers:

	mm:	TX6 x 75	TX9 x 75	
	mm:	TPX10 x 100	TPX15 x 100	TPX20 x 100
		TPX25 x 100	TPX30 x 100	

Item ID: **TT917TXN**



TT SERIES



**SCREWDRIVER SET TX TT2 12 PIECES**

- TT-MV PLUS steel alloy for greater strength and material flexibility
- Ergonomically designed bi-material handle for easy use with higher torque
- Hanging hole in the handle for use as a T handle or with a fall protection wire
- The handle is moulded around the blade to give a higher torque capacity
- Organised in a tool tray module size 2 (TT2)

Screwdrivers:

	mm:	TX6 x 75	TX7 x 75	TX8 x 75	TX9 x 75
		TX10 x 100	TX15 x 100	TX20 x 100	TX25 x 100
		TX27 x 100	TX30 x 100	TX40 x 100	TX45 x 125

Item ID: **TTD912TXN**



TT SERIES



**SCREWDRIVER BLADE SET MIXED TTI 12 PIECES**

- 22 screwdrivers in one set
- TT-MV PLUS steel alloy for greater strength and material flexibility
- Ergonomically designed bi-material handle for easy use with higher torque
- Hanging hole in the handle for use as a T handle or with a fall protection wire
- Organised in a tool tray module size 1 (TTI)

Screwdriver Blade Handle With 1/4" Shank

Screwdriver Blades:

	mm:	4 - 5.5
		PH1 - PH2
	mm:	PH3 - 6.5
		PZ1 - PZ2
	mm:	3 Ball - 3    4 Ball - 4    5 Ball - 5    6 Ball - 6
	TX:	10 - 15    20 - 25    30 - 40

Item ID: **TTMD12D**



TT SERIES



**POWER THROUGH SCREWDRIVER SET TTX4**

- Chrome vanadium blades for greater strength and material flexibility
- Percussion cap and full length integral blade for use with a hammer to release stubborn screws
- Ergonomically designed bi-material handle for easy use with higher torque and faster speed
- The handle is moulded around the blade to ensure straightness and to allow larger blade wings which give a higher torque capacity
- Organised in a tool tray module size X4 (TTX4)

Screwdrivers:

	mm:	6.5 x 100	8 x 150	10 x 200
	mm:	PH2 x 100	PH3 x 150	

Item ID: **TTXMDTN**

TT Series | Tool Trays



TT SERIES  
1

16 Pieces

MINI PLIERS & SCREWDRIVER SET TTI 16 PIECES

- Mini screwdrivers feature a rotating end piece for easier use when "transporting" the fastening
- Mini pliers feature high carbon steel construction and vinyl grip handles
- Organised in a tool tray module size 1 (TT1)

Mini Screwdrivers:

mm:	2.0 x 40	2.4 x 40	3.0 x 40
mm:	PH00 x 40	PH0 x 40	PH1 x 40
mm:	TX6 x 40	TX7 x 40	TX8 x 40
	TX9 x 40	TX10 x 40	TX15 x 40

Mini Pliers:

4 1/2"	SIDE CUTTER
4 1/2"	END CUTTER
5"	LONG NOSE PLIER
5"	FLAT NOSE PLIER

Item ID: TTM116



TT SERIES  
x4

9 Pieces mm

NUT DRIVER SET TTX4 9 PIECES

- 6 point socket ends for a perfect fit
- Chrome vanadium for greater strength and material flexibility
- Ergonomically designed bi-material handle for easy use with higher torque
- Hanging hole in the handle for use as a T handle or for use with a fall protection wire
- The handle is moulded around the blade which give a higher torque capacity
- Organised in a tool tray module size X4 (TTX4)

Nut Drivers:

mm	5, 5.5, 6, 7, 8, 10, 11, 12, 13 mm
----	------------------------------------

Item ID: TTXND

BITS & DRIVER SETS



TT SERIES  
1

49 Pieces 1/4"

BITS DRIVER SET TTI 49 PIECES

- Comprehensive selection of 25mm and 89mm 1/4" drive hex bits
- 1/4" drive regular sockets from 4 to 13mm
- Various drivers and accessories for use with bits and/or sockets
- Organised in a tool tray module size 1 (TT1)

147mm Quick chuck driver, 1/4" drive ratchet head adaptor, 1/4"M x 1/4" Hex adaptor

1/4" Drive Regular 6 point sockets:

mm:	4, 5, 5.5, 6, 7, 8, 9, 10, 11, 12, 13 mm
-----	--

1/4" Hex bits:

Length 25mm:	3.5, 5.5, 8 mm	PZ1, PZ2, PZ3
	PH1, PH2, PH3	2, 3, 4, 5, 6, 8
	TX10, TX15, TX20, TX25, TX30, TX40	
	TPX20, TPX25, TPX30	ROB1, 2, 3
Length 89mm:	PH1, PH2	4 mm PZ2
	TX10, TX20, TX25	4 mm

Item ID: TTMDQ49



TT SERIES



76 Pieces

1/4"

**BITS DRIVER SET TTI 76 PIECES**

- Quick chuck magnetic bits driver and adaptor for use with bits and/or sockets
- Organised in a tool tray module size 1 (TT1)

217mm Quick chuck screwdriver handle, 1/4"M x 1/4" Hex adaptor

1/4" Drive Regular 6 point sockets:

mm: 4, 5, 5.5, 6, 7, 8, 9, 10, 11, 12, 13 mm

1/4" Hex bits:

Length	3.5, 4.0, 4.5, 5.5 (x2), 6.5, 8.0 mm	PH2G (x3)
25mm:	PH1 (x3), PH2 (x6), PH3	ROB1, 2, 3
	TX6, TX7, TX8, TX9, TX10, TX15, TX20 (x3), TX25 (x3), TX27, TX30, TX40	
	TPX10, TPX15, TPX20 (x2), TPX25 (x2), TPX27, TPX30, TPX40	
	PZ1 (x3), PZ2 (x6), PZ3	2, 3, 4, 5, 6, 8

Item ID: **TTMDQ76**



TT SERIES



62 Pieces

1/4"

**T-HANDLE BITS DRIVER SET TTI 62 PIECES**

- Comprehensive selection of 25mm 1/4" drive hex bits included
- T-handle bits driver with quick chuck adaptor on the long end and a magnetic bits holder on the short end
- Organised in a tool tray module size 1 (TT1)

75mm Quick chuck T handle, 1/4"M x 1/4" Hex adaptor

1/4" Drive Regular 6 point sockets:

mm: 5, 5.5, 6, 7, 8, 9, 10, 11, 12, 13 mm

1/4" Drive TX-E bit sockets:

TX-E: E4, E5, E6, E7, E8

1/4" Hex bits:

Length	3.5, 5.5, 8 mm	PZ1, PZ2, PZ3
25mm:	PH1, PH2, PH3	2, 3, 4, 5, 6, 8
	TX6, TX7, TX8, TX9, TX10, TX15, TX20 (x3), TX25 (x3), TX27, TX30, TX40	
	TPX10, TPX15, TPX20 (x2), TPX25 (x2), TPX27, TPX30, TPX40	
	PH2G (x3)	ROB1, 2, 3

Item ID: **TTTHQ62**

## TT Series | Tool Trays

TT  
SERIES84  
Pieces

1/4"

## RATCHETING BITS DRIVER SET TTI 84 PIECES

- Reversible ratcheting bits driver, flexible extension and adaptor for use with bits and/or sockets
- Organised in a tool tray module size 1 (TTI)

Ratcheting Quick chuck screwdriver handle, 1/4" M x 1/4" Hex adaptor, 150mm flexible extension bar

1/4" Drive Regular 6 point sockets:

mm: 4, 5, 5.5, 6, 7, 8, 9, 10, 11, 12, 13 mm

1/4" Hex bits:

Length 25mm:	3.5, 4.0, 4.5, 5.5 (x2), 6.5, 8.0 mm	PH2G (x3)
	PH1 (x3), PH2 (x6), PH3	ROBI, 2, 3
	TX6, TX7, TX8, TX9, TX10, TX15, TX20 (x3), TX25 (x3), TX27, TX30, TX40	
	TPX10, TPX15, TPX20 (x2), TPX25 (x2), TPX27, TPX30, TPX40	
	PZ1 (x3), PZ2 (x6), PZ3	2, 3, 4, 5, 6, 8

Item ID: TTMDR84

TT  
SERIES38  
Pieces

## BITS DRIVER SET TTI 38 PIECES

- An extensive range of 1/4" hex drive 25mm screwdriver bits
- 2 quick chuck magnetic bit driver handles included giving a choice of shaft lengths
- Removable lid and dove tail joints
- Organised in a tool tray module size 1 (TTI)

147mm & 183mm Quick chuck screwdriver handles

1/4" Hex bits:

Length 25mm:	3.5, 5.5, 8 mm	PH1, PH2, PH3
	PZ1, PZ2, PZ3	ROBI, 2, 3
	TX10, TX15, TX20, TX25, TX30, TX40	
	TPX20, TPX25, TPX30	
	2, 3, 4, 5, 6, 8	
Length 89mm:	PH1, PH2	3, 4 mm
	PZ1, PZ2	TX10, TX20, TX25

Item ID: TTMDQ38

TT  
SERIES74  
Pieces

## RATCHETING SCREWDRIVER BIT SET TTI

- An extensive range of 1/4" hex drive 25mm screwdriver bits
- Reversible, magnetic, ratcheting bits driver, extension bars and adaptors included
- Removable lid and dove tail joints
- Organised in a tool tray module size 1 (TTI)

Ratcheting bits handle, 6" flexible extension, 4" extension, 1/4" M x 1/4" hex coupler adaptor, 1/4" F x 1/4" hex coupler adaptor

1/4" Hex bits:

Length 25mm:	3.5, 4.0, 4.5, 5, 5.5 (x2), 6.5, 7, 8 mm	PH2G
	PH1 (x4), PH2 (x7), PH3	ROBI, 2, 3
	TX6, TX7, TX8, TX9, TX10, TX15, TX20 (x3), TX25 (x3), TX27, TX30, TX40	
	TPX10, TPX15, TPX20 (x2), TPX25 (x2), TPX27, TPX30, TPX40	
	PZ1 (x4), PZ2 (x7), PZ3	2, 3, 4, 5, 6, 8

Item ID: TTMD74



TT  
SERIES



64  
Pieces

1/4"

### ANGLED RATCHETING BITS DRIVER SET TTI

- Comprehensive selection of 25mm 1/4" drive hex bits
- Ratcheting magnetic bits driver with an adjustable handle angle to create a pistol type grip driver
- Removable lid and dove tail joints
- Organised in a tool tray module size 1 (TTI)

Bits driver with adjustable angle setting,  
1/4" M x 1/4" hex coupler adaptor

1/4" Drive Regular 6 point sockets:

mm: 4, 5, 5.5, 6, 7, 8, 9, 10, 11, 12, 13 mm

1/4" Hex bits:

- |        |   |
|--------|---|
| Length | 3.5, 4, 4.5, 5, 5.5 (x2), 6.5, 7, 8 mm                                    |
| 25mm:  | PH1 (x4), PH2 (x4), PH3 (x2)    ROBI, 2, 3                                |
|        | TX6, TX7, TX8, TX9, TX10, TX15, TX20 (x3),<br>TX25 (x3), TX27, TX30, TX40 |
|        | PZ1, PZ2 (x3), PZ3 (x2)    2, 3, 4 (x3), 5, 6, 8                          |

Item ID: **TTMDRT64**



TT  
SERIES



41  
Pieces

1/4"

### SOCKET & BIT SET FLEXIBLE HANDLE TTX4

- Long reach bit and socket drivers set
- Comprehensive selection of 25mm 1/4" drive hex bits
- 1/4" drive regular sockets from 4 to 13mm
- Ideal for use in difficult to reach places
- Organised in a tool tray module size X4 (TTX4)

555mm flexible spinner handle with 1/4" drive,  
555mm flexible bits driver with 1/4" hex drive,  
1/4" M x 1/4" hex coupler adaptor

1/4" Drive Regular 6 point sockets:

mm: 4, 4.5, 5, 5.5, 6, 7, 8, 9, 10, 11, 12, 13 mm

1/4" Hex bits:

- |        |   |                   |
|--------|---|-------------------|
| Length | 4, 5.5, 8 mm                                  | 3, 4, 5, 6, 8, 10 |
| 25mm:  | PH0, PH1, PH2, PH3, PH4                       |                   |
|        | PZ0, PZ1, PZ2, PZ3                            |                   |
|        | TX8, TX10, TX15, TX20, TX25, TX27, TX30, TX40 |                   |

Item ID: **TTXMD41N**



## TT Series | Tool Trays



53  
Pieces













1/4"

## IMPACT BIT SET TTI 53 PIECES

- Screwdriver, hex and TX bits in various lengths
- Metric and AF impact nut setters included
- New design impact bits and adaptors for higher torsion
- Suitable for use with power tools
- Organised in a tool tray module size 1 (TTI)

60mm Impact magnetic bit holder, 60mm Impact quick chuck bit holder

1/4" Drive Impact nut setters - Length 65mm 

	Size: 1/4"	8	10	13
1/4" Hex Impact Bits: Length 30mm	 PH1, PH2 (x2), PH3	 PH2G (x2)	 1, 2	
	 PZ1, PZ2 (x2), PZ3	 3, 4 (x2), 5, 6		
	 TX10, TX15, TX20 (x2), TX25 (x2), TX27, TX30 (x2), TX40			
1/4" Hex Impact Bits: Length 50mm	 TX10, TX15, TX20, TX25, TX27, TX30, TX40			
	 3, 4, 5, 6	 PH2G	 1, 2, 3	 PZ2
1/4" Hex Impact Bits: Length 89mm	 TX20, TX25, TX30	 PH2 (x2)		

Item ID: **TTBS53**

## HEX &amp; TX KEYS



7  
Pieces

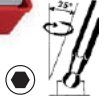

mm



## T-HANDLE BALL POINT HEX KEY SET TTI

- Ball point end on the long key end giving access at angles of up to 25°
- Regular hex end on the short arm gives the ability to apply higher torque
- Removable lid and dove tail joints
- Organised in a tool tray module size 1 (TTI)

## Ball Point T-Handle Hex Drivers:

 100 mm long:	2.5, 3, 4 mm
 150 mm long:	5, 6, 7 mm
 190 mm long:	8 mm

Item ID: **TTHEX7**



7  
Pieces



mm



## T-HANDLE HEX KEY SET TTI 7 PIECES

- Regular hex end on the short and long arms gives the ability to apply higher torque
- Removable lid and dove tail joints
- Organised in a tool tray module size 1 (TTI)

## T-Handle Hex Drivers:

 100 mm long:	2.5, 3, 4 mm
 150 mm long:	5, 6, 7 mm
 190 mm long:	8 mm

Item ID: **TTHEX7S**



**T-HANDLE BALL POINT HEX KEY SET AF TTI**

- Ball point end on the long key end giving access at angles of up to 25°
- Regular hex end on the short and long arms gives the ability to apply higher torque
- Removable lid and dove tail joints
- Organised in a tool tray module size 1 (TT1)

Ball Point T-Handle Hex Drivers:

	100 mm long:	3/32", 1/8", 5/32"
	150 mm long:	3/16", 7/32", 1/4"
	190 mm long:	5/16"

Item ID: **TTHEX7AF**



**T-HANDLE TX/TPX KEY SET TTI 7 PIECES**

- TPX type on the long key end for tamper proof TX fastenings
- Regular TX end on the short arm giving the ability to apply higher torque
- Removable lid and dove tail joints
- Organised in a tool tray module size 1 (TT1)

T-Handle TX Drivers:

	100 mm long:	TX/TPX10, TX/TPX15, TX/TPX20
	150 mm long:	TX/TPX25, TX/TPX27, TX/TPX30
	190 mm long:	TX/TPX40

Item ID: **TTTX7**



**BALL POINT HEX & TX KEY SET TTI 28 PIECES**

- Includes a range of ball point keys covering metric and AF hex key & TX keys
- Removable lid and dove tail joints
- Organised in a tool tray module size 1 (TT1)

Ball Point Hex & TX Keys:

	1.5, 2, 2.5, 3, 4, 5, 6, 7, 8, 10 mm
	5/64", 3/32", 1/8", 5/32", 3/16", 7/32", 1/4", 5/16", 3/8"
	TX8, TX9, TX10, TX15, TX20, TX25, TX27, TX30, TX40

Item ID: **TTHT28**

**PLIERS**



**PLIER SET VINYL GRIP TTI 4 PIECES**

- Vinyl grip for easier use in pockets or tool pouches
- All the most commonly used pliers in one set
- Organised in a tool tray module size 1 (TT1)

Pliers:

SIDE CUTTER	6" / 155 mm
COMBINATION	7" / 180 mm
LONG NOSE	8" / 200 mm
WATER PUMP	10" / 250 mm

Item ID: **TT440**

## TT Series | Tool Trays



8 Pieces

## PLIER SET VINYL GRIP TT2 8 PIECES

- Vinyl grip for easier use in pockets or tool pouches
- All the most commonly used pliers in one set
- Organised in a tool tray module size 2 (TT2)

Pliers:

HEAVY DUTY SIDE CUTTER	6" / 160 mm	LONG NOSE	6" / 160 mm
	8" / 200 mm		8" / 200 mm
HIGH LEVERAGE COMBINATION	6" / 160 mm	WATER PUMP	7" / 180 mm
	8" / 200 mm		10" / 250 mm

Item ID: **TTD441**

28 Pieces

TPR GRIP

## PLIER SET TPR GRIP TT1 4 PIECES

- TPR grip for a more secure and comfortable grip
- All the most commonly used pliers in one set
- Organised in a tool tray module size 1 (TT1)

Pliers:

SIDE CUTTER	6" / 155 mm
COMBINATION	7" / 180 mm
LONG NOSE	8" / 200 mm
WATER PUMP	10" / 250 mm

Item ID: **TT440-T**

TT SERIES



8 Pieces

TPR GRIP

## PLIER SET TPR GRIP TT2 8 PIECES

- TPR grip for a more secure and comfortable grip
- All the most commonly used pliers in one set
- Organised in a tool tray module size 2 (TT2)

Pliers:

HEAVY DUTY SIDE CUTTER	6" / 160 mm	LONG NOSE	6" / 160 mm
	8" / 200 mm		8" / 200 mm
HIGH LEVERAGE COMBINATION	6" / 160 mm	WATER PUMP	7" / 180 mm
	8" / 200 mm		10" / 250 mm

Item ID: **TTD441-T**

TT SERIES



2 Pieces

## PLIER &amp; WRENCH SET TTX4 2 PIECES

- 2 tools for gripping even the most stubborn nuts and bolts
- Organised in a tool tray module size X4 (TTX4)

Pliers:

QUICK ACTION WATER PUMP	10" / 250 mm
-------------------------	--------------

Wrenches

ALIGATOR ADJUSTABLE	8" / 200 mm
---------------------	-------------

Item ID: **TTXMB02**



TT SERIES



**CIRCLIP PLIER SET 12-25 MM TTI 4 PIECES**

- For use with inner and outer type circlips or snap rings
- 1.3mm tip and 12 to 25mm capacity
- Chrome vanadium construction
- Return spring for easier use
- Vinyl grip for easier use in pockets or tool pouches
- DIN5254/DIN5256
- Organised in a tool tray module size 1 (TTI)

5" / 130 mm Circlip Pliers:		Capacity
STRAIGHT	INNER	12 - 25 mm
	OUTER	12 - 25 mm
BENT	INNER	12 - 25 mm
	OUTER	12 - 25 mm

Item ID: **TT474-5**



TT SERIES



**CIRCLIP PLIER SET 19-60 MM TTI 4 PIECES**

- For use with inner and outer type circlips or snap rings
- 1.8mm tip and 19 to 60mm capacity
- Chrome vanadium construction
- Return spring for easier use
- Vinyl grip for easier use in pockets or tool pouches
- DIN5254 and DIN5256
- Organised in a tool tray module size 1 (TTI)

7" / 175 mm Circlip Pliers:		Capacity
STRAIGHT	INNER	19 - 60 mm
	OUTER	19 - 60 mm
BENT	INNER	19 - 60 mm
	OUTER	19 - 60 mm

Item ID: **TT474-7**



TT SERIES



**CIRCLIP PLIER SET PRO 12-25 MM TTI 4 PIECES**

- Invisible return spring for easier operation.
- For use with inner and outer type circlips or snap rings.
- 1.3mm bearing steel tip for heavy duty applications.
- Non slip tip angle enabling the ring to stock securely to the tip when compressing or expanding the circlip.
- 12 to 25mm capacity.
- Chrome vanadium construction.
- Vinyl grip for easier use in pockets or tool pouches
- DIN5254 and DIN5256
- Organised in a tool tray module size 1 (TTI)

5" / 130 mm Circlip Pliers:		Capacity
STRAIGHT	INNER	12 - 25 mm
	OUTER	12 - 25 mm
BENT	INNER	12 - 25 mm
	OUTER	12 - 25 mm



Item ID: **TT474-5E**



TT SERIES



**CIRCLIP PLIER SET PRO 19-60 MM TTI 4 PIECES**

- Invisible return spring for easier operation
- For use with inner and outer type circlips or snap rings
- 1.8mm bearing steel tips for heavy duty applications
- Non slip tip angle enabling the ring to stock securely to the tip when compressing or expanding the circlip
- 19 to 60mm capacity
- Chrome vanadium construction
- Return spring for easier use
- Vinyl grip for easier use in pockets or tool pouches
- DIN5254 and DIN5256
- Organised in a tool tray module size 1 (TTI)

7" Circlip Pliers:		Capacity
STRAIGHT	INNER	19 - 60 mm
	OUTER	19 - 60 mm
BENT	INNER	19 - 60 mm
	OUTER	19 - 60 mm



Item ID: **TT474-7E**

## TT Series | Tool Trays

TT  
SERIES**CIRCLIP PLIER SET 40-100 MM TTX4 4 PIECES**

- For use with inner and outer type circlips or snap rings
- 2.3mm tip and 40 to 100mm capacity
- Chrome vanadium construction
- Return spring for easier use
- Vinyl grip for easier use in pockets or tool pouches
- DIN5254 and DIN5256
- Organised in a tool tray module size X4 (TTX4)

9" / 225 mm Circlip Pliers:		Capacity
STRAIGHT	INNER	40 - 100 mm
	OUTER	40 - 100 mm
BENT	INNER	40 - 100 mm
	OUTER	40 - 100 mm

Item ID: **TTX474-9**TT  
SERIES**CIRCLIP PLIER SET PRO 40-100 MM TTX4**

- Invisible return spring for easier operation.
- For use with inner and outer type circlips or snap rings.
- 2,3mm bearing steel tip for heavy duty applications.
- Non slip tip angle enabling the ring to stock securely to the tip when compressing or expanding the circlip.
- 40 to 100mm capacity.
- Chrome vanadium construction.
- Vinyl grip for easier use in pockets or tool pouches
- DIN5254 and DIN5256
- Organised in a tool tray module size X4 (TTX4)

9" / 225 mm Circlip Pliers:		Capacity
STRAIGHT	INNER	40 - 100 mm
	OUTER	40 - 100 mm
BENT	INNER	40 - 100 mm
	OUTER	40 - 100 mm



INVISIBLE RETURN SPRING

Item ID: **TTX474-9E**TT  
SERIES5  
Pieces**POWER GRIP PLIER SET TTI 5 PIECES**

- All the most commonly used power grip pliers in one set
- Self locking with release lever
- With locking nut on adjustment knob for pre-setting, ideal for repeated use
- Wire cutter and crimper function
- Chrome molybdenum
- Organised in a tool tray module size 1 (TTI)

Power Grip Pliers:		
		4" / 100 mm
STANDARD ROUND JAW		7" / 180 mm
		10" / 250 mm
LONG NOSE		4" / 100 mm
		6" / 155 mm

Item ID: **TTVG05**TT  
SERIES3  
Pieces**POWER GRIP PLIER SET TTX2 3 PIECES**

- The most commonly used power grip pliers in one set
- Self locking with release lever
- With locking nut on adjustment knob for pre-setting, ideal for repeated use
- Wire cutter and crimper function
- Chrome molybdenum
- Organised in a tool tray module size X2 (TTX2)

Power Grip Pliers:		
STANDARD ROUND JAW		4" / 100 mm
		4" / 100 mm
LONG NOSE		6" / 155 mm

Item ID: **TTZVG03**



**POWER GRIP PLIER SET TT4 4 PIECES**

- Includes all the most commonly used welding pliers in one set
- Designed to fit exactly in TengTools tool box drawers
- Can be used as a set on it's own or as part of the TengTools Tool Control system
- Organised in a tool tray module size 4 (TT4)

Power Grip Pliers:	
LONG NOSE	6" / 155 mm
SHEET METAL GRIP	8" / 230 mm
WELDING GRIP	9" / 230 mm
C CLAMP PLIER	11" / 280 mm

Item ID: **TTPSPG**

**INSULATED TOOLS**



**INSULATED SCREWDRIVER SET MIXED TT1**

- Approved for live working up to 1,000 volts
- Integrated protective insulation with two colours to clearly indicate if there is any damage
- Designed and manufactured to DIN ISO 2380, DIN ISO 8764-1 and IEC 60900
- Organised in a tool tray module size 1 (TT1)

1000V Insulated Screwdrivers:	
mm:	4 x 100    5.5 x 125
mm:	PH1 x 80    PH2 x 100
mm:	PZ1 x 80    PZ2 x 100

Item ID: **TTV706N**



**INSULATED SCREWDRIVER SET MIXED TTI**

- Approved for live working up to 1,000 volts
- Integrated protective insulation with two colours to clearly indicate if there is any damage
- Designed and manufactured to DIN ISO 2380, DIN ISO 8764-1 and IEC 60900
- Organised in a tool tray module size 1 (TT1)

1000V Insulated Screwdrivers:			
mm:	2.5 x 75	4 x 100	5.5 x 125
mm:	PH0 x 60	PH1 x 80	PH2 x 100
mm:	PZ2 x 100		

Item ID: **TTV907N**



**INSULATED SCREWDRIVER SET MIXED TT2**

- Approved for live working up to 1,000 volts
- Integrated protective insulation with two colours to clearly indicate if there is any damage
- Designed and manufactured to DIN ISO 2380, DIN ISO 8764-1 and IEC 60900
- Organised in a tool tray module size 2 (TT2)

1000V Insulated Screwdrivers:			
mm:	2.5 x 75	3 x 100	4 x 100    5.5 x 125
mm:	PH0 x 60	PH1 x 80	PH2 x 100
mm:	PZ0 x 60	PZ1 x 80	PZ2 x 100

Item ID: **TTDV910N**

## TT Series | Tool Trays



TT SERIES  
1

10 Pieces

### INSULATED SCREWDRIVER BLADE SET TTI

- Interchangeable blades for a wide range of tips in one set
- Approved for live working up to 1,000 volts
- Designed and manufactured to DIN ISO 2380, DIN ISO 8764-1 and IEC 60900
- Organised in a tool tray module size 1 (TTI)

1000V Insulated handles: 22x100mm, 37x122mm

1000V Insulated Screwdriver blades:

Reg mm:	3 x 70		
Slim mm:	4 x 100	5.5 x 80	6.5 x 100
Slim mm:	PH1 x 80	PH2 x 100	
Slim mm:	PZ1 x 80	PZ2 x 100	

Item ID: **TTV710N**



TT SERIES  
1

4 Pieces TPR GRIP

### INSULATED PLIER SET TTI 4 PIECES

- Approved for live working up to 1,000 volts
- TPR grip for a more secure and comfortable grip
- Designed and manufactured to DIN5745, DIN5746, DIN5749 and IEC 60900
- Organised in a tool tray module size 1 (TTI)

1000V Insulated Pliers:

SIDE CUTTER	6" / 150 mm
LONG NOSE	8" / 200 mm
COMBINATION PLIERS	7" / 175 mm
WIRE STRIPPING PLIERS	6" / 155 mm

Item ID: **TTV440**

NEW



TT SERIES  
1

9 Pieces

### 1000V TORQUE SCREWDRIVER BLADE SET TTI

- Slim blades with reduced blade diameter for easier access to recessed screws and spring elements
- Approved for live working up to 1,000 volts
- Designed and manufactured to IEC 60900
- Organised in a tool tray module size 1 (TTI)

Insulated Torque Screwdriver 1/4 in 1-5Nm 1000V

1000V Insulated Screwdriver blades:

Reg mm:	3 x 70		
Slim mm:	4 x 100	5.5 x 80	6.5 x 100
Slim mm:	PH1 x 80	PH2 x 100	
Slim mm:	PZ1 x 80	PZ2 x 100	

Item ID: **TTVSD09**

NEW



TT SERIES  
1

14 Pieces 3/8" mm

### INSULATED SOCKET SET 3/8" DRIVE TTI

- Approved for live working up to 1,000 volts
- 6 point single hexagon socket for a better grip
- Integrated protective insulation with two colours to clearly indicate if there is any damage to the insulation
- Designed and manufactured to DIN, ISO and IEC 60900
- Organised in a tool tray module size 1 (TTI)

3/8" Drive Insulated Ratchet

6" Insulated Extension bar

Regular 6 point Insulated sockets:

mm:	8	9	10	11	12	13
	14	15	16	17	18	19

Item ID: **TTV3814**

CUTTING TOOLS



TT SERIES

1	2
---	---

5 Pieces

CUTTING TOOL SET TT2 5 PIECES

- Includes high leverage tin snips for straight, left and right cutting
- Utility knife with retractable blade and ergonomic grip
- High carbon stainless steel blade industrial scissors
- Heavy duty cable cutters with compound leverage for easier cutting
- Organised in a tool tray module size 2 (TT2)

Cutting Tools:

Tin snips (straight/left & straight/right), utility knife, scissors, heavy duty cable cutters

Item ID: TTDCT05



TT SERIES

1		
---	--	--

40 Pieces

KNIFE SET TTI 40 PIECES

- Includes a selection of different knives to suit all types of use
- Spare blades included for each type of knife
- Organised in a tool tray module size 1 (TT1)

Knives:

Utility knife with auto load function, folding universal knife, folding mini utility knife, hobby knife with 9mm blade, hobby knife with 18mm blade

Spare blades:

5 x Regular knife blades, 10 x Mini knife blades, 10 x 9mm Snap off blades, 10 x 18mm Snap off blades

Item ID: TTK40



TT SERIES

1		
---	--	--

28 Pieces



DRILL BIT SET 1.0-13.0 MM TTI 28 PIECES

- Standard drill bits for use with steel and cast iron, etc.
- Spiral angle of 28° for clean cutting
- Split point angle of 118° for better positioning
- Shank the same diameter as the tip
- Designed and manufactured to DIN338
- Organised in a tool tray module size 2 (TT2)

Fully Ground Drill Bits:

1.0 (x3), 1.5 (x3), 2.0 (x2), 2.5 (x2), 3.0, 3.5, 4.0, 4.5, 5.0, 5.5, 6.0, 6.5, 7.0, 7.5, 8.0, 8.5, 9.0, 10.0, 10.5, 11.0, 12.0, 13.0

Item ID: TTDB28



TT SERIES

1		
---	--	--

17 Pieces

TAP AND DIE SET TTI 17 PIECES

- Suitable for repairing damaged threads from M3 to M12
- Tap and die holders included
- A thread gauge is included to help identify the pitch of the thread
- Organised in a tool tray module size 1 (TT1)

Metric dies:

3x0.5 mm, 4x0.7 mm, 5x0.8 mm, 6x1.0 mm, 8x1.25 mm, 10x1.5 mm, 12x1.75 mm

Metric taps:

3mm, 4mm, 5mm, 6mm, 8mm, 10mm, 12mm

Accessories:

Tap handle (capacity 3 to 12mm), die handle with adjustment screw (capacity 3 to 12mm), screw pitch gauge

Item ID: TTTDI7



## TT Series | Tool Trays

TT  
SERIES34  
Pieces

## TAP AND DIE SET TT2 34 PIECES

- Designed for the repair of damaged threads covering M3 to M12
- Includes taps and dies with interchangeable chucks
- Screw extractors also included to give a complete set for repairing threads
- Various accessories including drill bits, a screw pitch gauge and mini palm ratchet
- Organised in a tool tray module size 2 (TT2)

Metric dies:

3x0.5 mm, 4x0.7 mm, 5x0.8 mm, 6x1.0 mm, 8x1.25 mm, 10x1.5 mm, 12x1.75 mm

Metric taps:

3mm, 4mm, 5mm, 6mm, 8mm, 10mm, 12mm

Fully ground drill bits:

2.5, 3.3, 4.2, 5.0, 6.8, 8.5, 10.5 mm

Screw extractors:

1/8", 3/16", 15/64", 5/16", 3/8"

Accessories:

Screw pitch gauge, mini screwdriver hex (2.5x40mm), 1/4" extension bar, 3/8"F x 1/4"M adaptor, 1/4" mini palm ratchet, 1/4" interchangeable die chuck, 1/4" tap chuck (x2 - M3-M8, M5-M12)

Item ID: **TTD34**TT  
SERIES12  
Pieces

## NEEDLE FILE SET TTI 12 PIECES

- All the most commonly used types of needle file in one handy set
- Removable lid and dove tail joints
- Organised in a tool tray module size 1 (TT1)

Needle Files:

Hand, half round, three square, square, round, flat point, knife type, barrette, crossing, oval, feather edge, round edge flat

Item ID: **TTNF12**TT  
SERIES5  
Pieces

## HAND FILE SET TTX4 5 PIECES

- 10" high carbon steel hand files
- Bi-material handle for a more comfortable grip
- 2nd cut to create a diamond pattern cutting surface for smoother filing
- Cut on both edges of the flat files for filing grooves, etc
- Organised in a tool tray module size X4 (TTX4)

10" Files:

Flat, Hand, Half Round, Round, Three square

Item ID: **TTXF05**

MEASURING TOOLS



MEASURING TOOL SET TTI 4 PIECES

- Ideal for engineers and technicians
- Includes a 4 function vernier caliper, steel rule, scriber and base square
- Organised in a tool tray module size 1 (TTI)

Measuring Tools:	
Vernier Caliper	150mm / 6"
Steel Rule	150 mm
Base Square	100 x 70 mm
Scriber	150 mm

Item ID: **TTBM**

AUTO TOOLS



HOOK & PICK SET TTI 4 PIECES

- 4 piece hook and pick set
- Includes hooks, awls and picks for detail work and scribing
- Ideal for cleaning components and retrieving lost items in hard to reach places
- Organised in a tool tray module size 1 (TTI)

Hooks & Picks:	
Straight Awl, 35° Hook tool, 90° Hook Tool, 125° Hook Tool	

Item ID: **TTMDP**



SCRAPER SET TTI 4 PIECES

- Includes a gasket scraper, an awl and two hook tools
- Ideal for cleaning, scraping and removing unwanted residue
- Organised in a tool tray module size 1 (TTI)

Scrapers:	
Gasket scraper	22mm wide blade, total length 245mm
Hooks & awl	
Curved hook, 90° hook and awl	

Item ID: **TTSR04**



MEASURING TOOL SET TT2 4 PIECES

- Ideal for mechanics and technicians
- Includes a 4 function digital caliper, multimeter, thread gauge and feeler gauge sets
- Organised in a tool tray module size 2 (TT2)

Measuring Tools:	
Digital Caliper	150mm / 6"
Thread Gauge Set	0.25-6.0mm, 4-42 UNC
Feeler Gauge Set	100mm Length, 0.05-1.0mm
Multimeter	AC, DC, voltage, current, resistance, temperature, CAT II 250V

Item ID: **TTDCM**

## TT Series | Tool Trays

TT  
SERIES3  
Pieces

## HOSE CLAMP SET TTI 3 PIECES

- Range of sizes giving a capacity of 6 to 57mm (1/4" to 2 1/4")
- Specially designed jaws prevent internal hoses from damage when clamping
- Lightweight and easy to use
- Non conductive
- Organised in a tool tray module size 1 (TTI)

Hose clamps:

For hoses: 1/4"-3/4", 1/4"-1-1/4", 3/4"-2-1/4"

Item ID: TTHC03

TT  
SERIES7  
Pieces

3/8"

1/2"

## AUTOMOTIVE SOCKET SET TTI 7 PIECES

- All the most commonly used specialist automotive sockets in one handy set
- Includes sockets for removing and installing injectors, oil sender and vacuum switches as well as various oxygen sensors
- Organised in a tool tray module size 1 (TTI)

3/8" Drive Sockets:

22 mm	Length: 90 mm	Oxygen sensor socket for Mitsubishi, Nissan, Opel, Vauxhall & VW
7/8"	Length: 80 mm	Vacuum switch socket
1-11/16"	Length: 74 mm	Oil sender socket
7/8"	Length: 30 mm	Offset oxygen sensor socket

1/2" Drive Sockets:

29 mm	Length: 90 mm	Oxygen sensor socket for GM
27 mm	Length: 85 mm	Injector socket for M24
7/8"	Length: 50 mm	Heated oxygen sensor socket

Item ID: TTSS07

TT  
SERIES16  
Pieces

3/8"

## OIL SERVICE SET TTI 16 PIECES

- All the tools normally required for an oil service included in one handy set
- Includes an oil filter wrench, drain plug set, spark plug sockets, metric feeler gauge set and a 3 in 1 inspection tool with magnetic pick up
- Organised in a tool tray module size 1 (TTI)

3/8" Drive Accessories:

3" &amp; 10" wobble extensions, 1/2"F x 3/8" Male T-bar adaptor

3/8" Drive Sockets:

21mm regular 6 point socket, 16 &amp; 21mm spark plug sockets

Drain Plug Set:

Bar, 5/16" hex x 3/8" hex, 11mm square x 12mm hex, 17mm hex x 1/2" hex, 8mm square x 3/8" square, 13mm square x 14mm hex, 8mm hex x 10mm hex

Service Tools:

Strap type oil filter wrench, 3 in 1 telescopic inspection tool, 20 piece feeler gauge set (0.05 mm - 1.0 mm)

Item ID: TTOS16

TT  
SERIES5  
Pieces

3/8"

mm

## 3/8" T BAR SPARK PLUG SOCKET SET TTX4

- Magnet spark plug sockets
- 3/8" drive extra long swivelling magnetic spark plug sockets for use in hard to reach places
- T bar with the TengTools T-HD handle for more comfortable use
- Organised in a tool tray module size X4 (TTX4)

2 Piece T bar handle

3/8" Drive extra long swivelling spark plug sockets:

mm: 14 16 21

Item ID: TTXTB05



TT  
SERIES  
x4

9  
PIECES  
3/8" mm

**3/8" LONG T BAR SOCKET SET TTX4 9 PIECES**

- Extra long socket set
- 3/8" drive extra long sockets for use in hard to reach places
- T bar with the TengTools T-HD handle for more comfortable use
- Organised in a tool tray module size X4 (TTX4)

2 Piece T bar handle	
3/8" Drive extra long sockets:	
	mm: 8 10 12 13 14 17 19

Item ID: **TTXTB09**



TT  
SERIES  
4

5  
PIECES

**BODYWORK HAMMER SET TT4 5 PIECES**

- A selection of hammers for use in the automotive body shop or metal working area
- Organised in a tool tray module size 4 (TT4)

Hammers:
Dead blow hammers with 35 and 55mm diameter heads, crown face hammers with straight pein, pick heads and square milled face

Item ID: **TTPSAD**

**SERVICE TOOLS**



TT  
SERIES  
1

10  
PIECES

**FLARING TOOL SET TT1 10 PIECES**

- Suitable for copper, brass and thin walled aluminium tubing
- 45° tube press flare pipes from 4 to 14mm diameter
- Heavy duty pipe cutter included for cutting pipes up to 32mm (1-1/4") diameter
- Organised in a tool tray module size 1 (TT1)

2 piece double flaring tool set	
Pipe Cutter:	3-32 mm (1/8"-1-1/4")
Adaptors:	4, 4.75 (3/16"), 6 (1/4"), 8 (5/16"), 10, 12, 14 mm

Item ID: **TTTTF10**



TT  
SERIES  
1

4  
PIECES

**PULLER SET TT1 4 PIECES**

- Three legged combination puller
- Supplied with an extra yoke for switching to two legged pulling
- Reversible legs for internal or external grip
- Organised in a tool tray module size 1 (TT1)

Pullers:
Combination twin/triple 6" leg puller with 4" capacity

Item ID: **TT804**

## TT Series | Tool Trays

TT  
SERIES11  
Pieces

1/2"

**EXTRACTOR & NUT SPLITTER SET TTI**

- Includes screw extractors, stud extractors and nut splitters
- Ideal for use with broken nuts, bolts, studs or screws
- Organised in a tool tray module size 1 (TT1)

1/2" Drive Stud Extractors:

6, 8, 10, 12 mm

Screw Extractors:

7/64", 9/64", 5/32", 1/4", 19/64"

Nut Splitters:

5 to 20mm, 14 to 27mm

Item ID: **TTSN11**TT  
SERIES18  
Pieces

3/8"

1/2"

**STUD EXTRACTOR SET TTI 18 PIECES**

- Includes all the most commonly used sizes from 6mm (5/16") to 25mm (1")
- Designed for removing rounded or damaged bolt heads or nuts
- 4mm parallel pin punch included for clearing debris from the extractors
- Chrome vanadium satin finish
- Designed and manufactured to DIN3120/3124 and ISO2725
- Organised in a tool tray module size 1 (TT1)

3/8" Drive Stud Extractors:

6 (5/16"), 8, 10 (3/8"), 11 (7/16"), 12, 13 (1/2"), 14 (9/16"), 16 (5/8"), 17 mm

1/2" Drive Stud Extractors:

19, 21, 22, 24, 25 mm

3/4", 13/16", 7/8", 15/16", 1"

Parallel Pin Punch:

4mm (150mm length)

Item ID: **TTBE18**TT  
SERIES3  
Pieces**PRY BAR SET ROLL/HEEL TTX4 3 PIECES**

- Includes roll/heel bars in three sizes to suit different applications
- Organised in a tool tray module size X4 (TTX4)

Roll heel bars:

12", 16", 20"

Item ID: **TTXPB3**TT  
SERIES3  
Pieces**PRY BAR SET TTX4 3 PIECES**

- Includes pry bars in three sizes and shapes to suit different applications
- Organised in a tool tray module size X4 (TTX4)

Roll heel bars:

12", 18", 22"

Item ID: **TTXPB3A**



TT  
SERIES



121  
Pieces

**CRIMPING PLIER SET TTI 121 PIECES**

- Multi function 9" crimping plier and wire stripper
- Use on insulated, non insulated terminals and connectors
- Wire stripping capacity from 0.75 to 6mm
- Cutting function for M2.5 to M5 bolt sizes
- Includes a range of insulated, non insulated terminals and connectors
- Organised in a tool tray module size 1 (TT1)

Crimping Tool:

Multi function CP50 crimping tool

Terminals/connectors:

- Red #6 ring terminals x 20
- Blue #8 spade terminals x 20
- Red butt connectors x 20
- Blue butt connectors x 20
- Blue 6.3x0.8mm female connectors x 20
- Blue 6.3x0.8mm male connectors x 20

Item ID: **TTCP121**



TT  
SERIES



4  
Pieces

**CRIMPING PLIER SET TTI 4 PIECES**

- Interchangeable ratchet crimping tool
- Automatic locking mechanism to ensure a consistent and correct crimping action
- Includes a range of interchangeable heads
- Use on insulated, non insulated terminals and connectors
- Organised in a tool tray module size 1 (TT1)

Crimping Tool:

Changeable ratchet crimping tool for insulated terminals 22-10 AWG

Terminals/connectors:

Die for non-insulated open barrel connector, commercial type 22-12 AWG (0.324 square mm - 3.31 square mm)

Die for non-insulated terminals 22-8 AWG (0.324 square mm - 8 square mm)

Other Tools:

Hex hey wrench 2.5mm

Item ID: **TTCP04**



TT  
SERIES



6  
Pieces

**PIPE CUTTER SET TTI 6 PIECES**

- For cutting plastic, copper and brass pipes from 3 to 22mm diameter
- Deburring tool included for tidying up any sharp edges
- Organised in a tool tray module size 1 (TT1)

Pipe Cutters:

Capacity: 10, 12, 15, 22 mm  
Adjustable pipe cutter capacity: 3-22 mm

Accessories:

Deburring tool

Item ID: **TTTC06**

## TT Series | Tool Trays

TT  
SERIES81  
Pieces

## RIVET GUN SET TTI 81 PIECES

- Aluminium alloy, forged steel upper handle with heat treated jaws for durability
- Suitable for aluminium and steel rivets from 2.4 to 4.8mm and stainless steel rivets up to 4.0mm
- Includes 80 assorted rivets in individual storage compartments
- Organised in a tool tray module size 1 (TTI)

Hand rivetter:

4 nozzles to suit aluminium/steel blind rivets (2.4, 3.2, 4.0, 4.8 mm)

Aluminium rivets:

2.4mm (3/32") x 20 black  
 3.2mm (1/8") x 20 black  
 4.0mm (5/32") x 20 black  
 4.8mm (3/16") x 20 black

Accessories:

Nozzle wrench

Item ID: **TTHR81**TT  
SERIES81  
Pieces

## NUTSERT GUN SET TTI 81 PIECES

- Aluminium alloy, forged steel upper handle with heat treated jaws for durability
- Quick change, lockable threaded mandrels
- Mandrels for M3, M4, M5 and M6 included
- Includes 80 assorted nutserts in individual storage compartments
- Organised in a tool tray module size 1 (TTI)

Nutsert Tool:

4 quick change mandrels (M3 x 0.5, M4 x 0.7, M5 x 0.8, M6 x 1.0)

Aluminium rivets:

M3 x 20 pieces  
 M4 x 20 pieces  
 M5 x 20 pieces  
 M6 x 20 pieces

Accessories:

Nose piece wrench

Item ID: **TTNR81**TT  
SERIES3  
Pieces

## INSPECTION SET TTI 3 PIECES

- Ideal set for finding and retrieving lost nuts and bolts, etc.
- An extending mirror and magnifier with adjustable heads
- The extending magnetic pick up tool helps retrieve items up to 4,500g
- Mirror & magnifying glass extend to 850mm and the magnet extends to 760mm
- Organised in a tool tray module size 1 (TTI)

Inspection Tools:

Telescopic magnifying glass  
 Telescopic inspection mirror  
 Telescopic magnetic pick up tool

Item ID: **TTM03**



TT SERIES



8 Pieces

**INSPECTION SET TTI 8 PIECES**

- Ideal set for finding and retrieving lost nuts and bolts, etc.
- Includes telescopic magnetic pick up, magnifying glass, inspection mirror, a flexible claw pick up and even an LED torch
- Organised in a tool tray module size 1 (TT1)

Inspection Tools:

- LED flashlight
- Flexible magnetic pick up, length 310mm
- Telescopic magnetic pick up, length 160-480mm
- 38mm magnifying glass 1:3 with magnetic adaptor
- 38mm inspection mirror with magnetic adaptor
- 230mm flexible claw pick up tool
- Batteries AAA (2 pieces)

Item ID: **TTM08**



TT SERIES



9 Pieces

**PUNSCH & CHISEL SET TTI 9 PIECES**

- Flat cold chisel made from chrome molybdenum
- Pin punches made from chrome molybdenum
- Organised in a tool tray module size 1 (TT1)

Punches:

Centre	Length: 150 mm	5 mm
Parallel	Length: 150 mm	3, 4, 5, 6, 7, 8 mm

Flat cold chisels:

150 mm	Width: 19 mm
200 mm	Width: 25 mm

Item ID: **TTPC09**

**AIR TOOLS**



TT SERIES



13 Pieces

1/2"

**1/2" AIR IMPACT WRENCH SET TT2 13 PIECES**

- Compact and lightweight 1/2" drive impact wrench
- For use in confined spaces
- Supplied with stubby 1/2" drive impact sockets
- Supplied in the unique TengTools TT2 module to be used within the Tool Control system
- Organised in a tool tray module size 2 (TT2)

Impact Sockets - 1/2" Stubby:

10, 12, 13, 14, 15, 16, 17, 18, 19, 21, 22, 24 mm

Compact Impact Wrench Specification:

Square drive		1/2"
Bolt capacity	mm	M16
Free speed	rpm	8,000
Max torque (3 steps)	Nm	285/380/680
Max torque (3 steps)	ft-lb	210/280/501
Max reverse torque	Nm	770
Max reverse torque	ft-lb	568
Hammer mechanism	type	Jumbo hammer
Sound level *	dB	102
Vibration **	m/s <sup>2</sup>	7.5
Minimum hose size	inch	3/8"
Air inlet	inch	1/4"
Air consumption at 100% int.	l/min	121
Air consumption at 100% int.	cfm	4.23
Air consumption at 15% int.	l/min	18
Air consumption at 15% int.	cfm	0.6
Length	mm	113
Weight	kg	1.3

Item ID: **TTDAWM13M**



# FOAM SERIES TOOL KITS

## Better tools bring better results

Each tool kit has been compiled with the help of technicians from various trades and are available in many shapes and sizes. From full stacks to roller cabinets, and top boxes to portable solutions, there is a kit to fit your exact needs

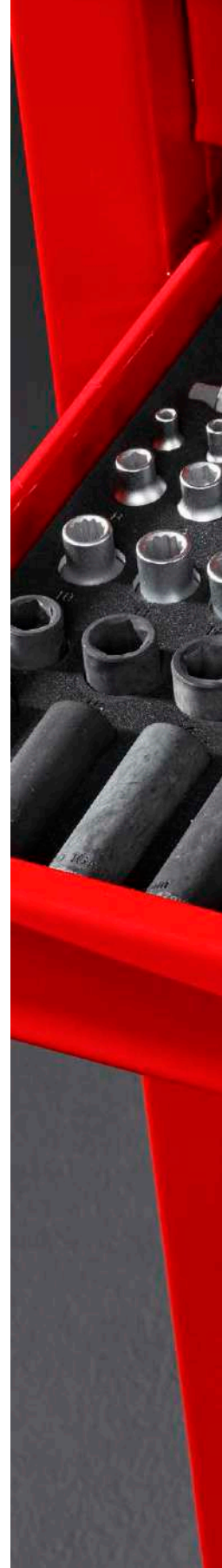

### FOAM SERIES



**Protection:** FOAM Series tool trays provide a protective layer between the tools and the storage solution, helping to prevent damage and scratching.



**Organisation:** Each tool has its own place with its description imprinted in the 3-coloured foam. The contrasting colours make it easy to identify tools and see when a tool is missing.



**Customisability:** We can provide a bespoke custom FOAM Series toolkit based around your existing tools and equipment. Contact your local retailer for more information.



**Safety:** FOAM Series tool trays can also help reduce the risk of injury by keeping sharp or dangerous tools secure and separated from other tools.



**Cold environments:** The high quality FOAM stays soft and flexible even in cold environments and gives the tool kit a premium look.

Get Organised™

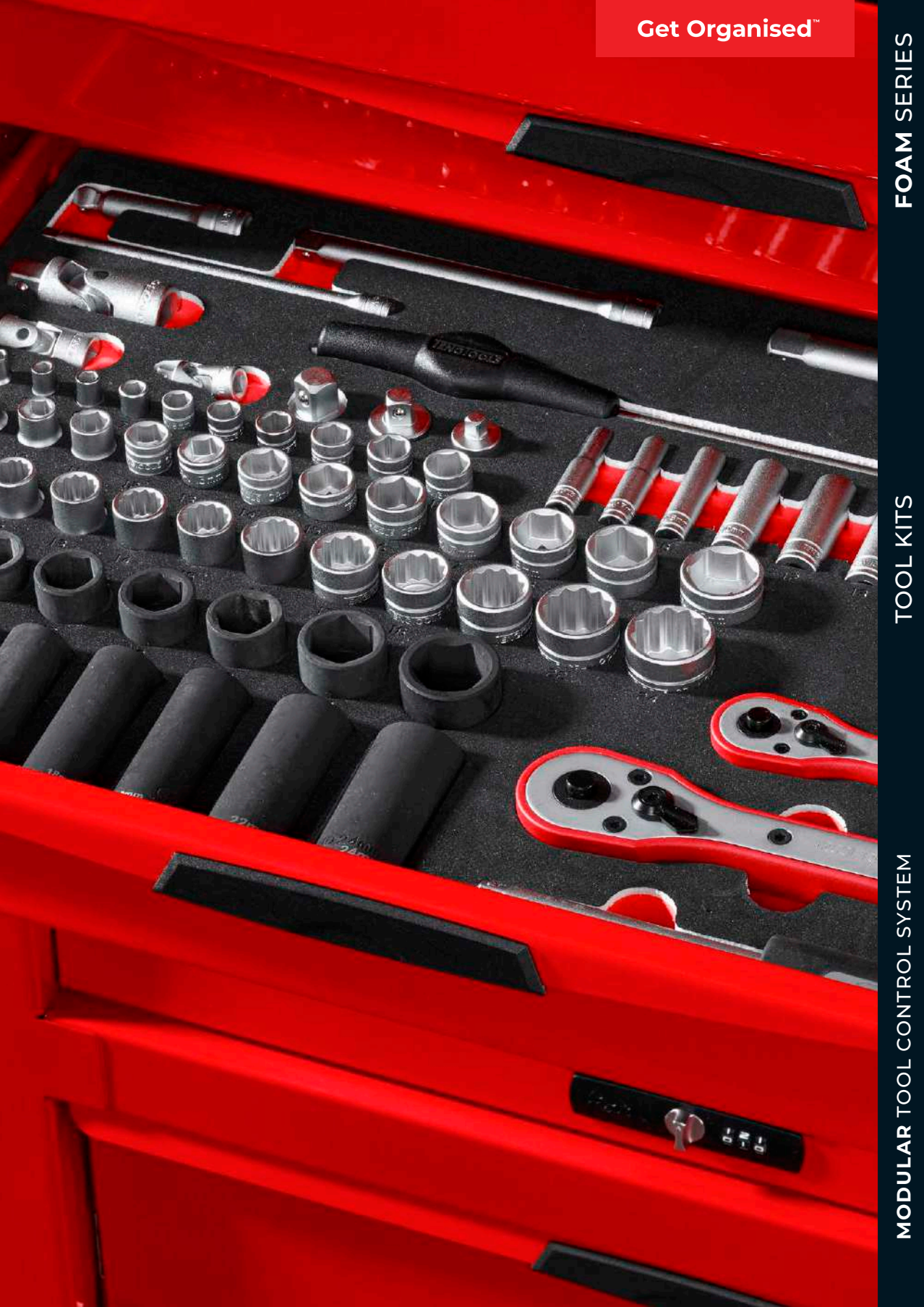

FOAM SERIES

TOOL KITS

MODULAR TOOL CONTROL SYSTEM

FOAM Series | Tool Kits

FOAM  
SERIES

MONSTER™

53" PRO ULTIMATE FOAM MONSTER 1117 PIECES

- A complete tool kit covering the requirements of most users
- All the tools are laid out in three colour pre-cut high-density EVA foam modules with each tool having it's own place
- Clearly shows if any tools are not in their correct place to prevent losing tools or leaving them in the work piece
- The kit contains 33 pre-cut foam modules containing over 1115 individual pieces
- Supplied in a red TengTools 53" 19 drawer stack system with 10 drawer top box and the 9 drawer roller cabinet



- 19** Drawer
- 53" Wide Cabinet**
- Heavy Gauge Steel**
- 5-Step Rust Protection**
- 6" Castor Wheels with Brakes**
- Comfort Grip Handle**
- 3 Step Ball Bearing Slides**
- 1117** Pieces **342.8 kg**
- Combination Lock**



Drawer 1/10



Drawer 2/10



Drawer 3/10



Drawer 4/10



Drawer 5/10



Drawer 6/10

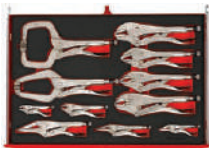

Drawer 7/10



Drawer 8/10



Drawer 9/10

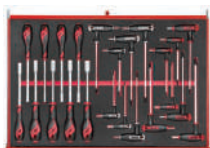

Drawer 10/10



Drawer 1/9



Drawer 2/9



Drawer 3/9

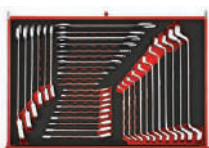

Drawer 4/9



Drawer 5/9



Drawer 6/9



Drawer 7/9



Drawer 8/9



Drawer 9/9

Drawer	Item ID	Description
Storage	TC810N	53" PRO Top Box 10 Drawers Red
	TCW809N	53" PRO Cabinet 9 Drawers Red
1/10	TEXEXT13	Extension Bars Set FOAMX4 13 Pieces
1/10	TEABS50	Impact Bit Set FOAM1 50 Pieces
1/10	TEAMDQ78	Bits Driver Set FOAM1 78 Pieces
1/10	TEAHR81	Rivet Gun Set FOAM1 81 Pieces
1/10	TEA01	Storage Tray FOAM1 7 Compartments
2/10	TEXTB05	3/8" T Bar Spark Plug Skt Set FOAMX4 5 Pieces
2/10	TEDV440	Insulated Plier Set FOAM2 4 Pieces
2/10	TEDV909N	Insulated Screwdriver Set Mixed FOAM2 9 Pieces
3/10	TEXMDTN	Power Through Screwdriver Set FOAMX4 5 Pieces
3/10	TEDSD14	Torque Screwdriver Set FOAM2 95 Pieces
3/10	TEDHT42	Ball Point Hex & TX Key Set FOAM2 42 Pieces
4/10	TEXFLS06	Long Double Ring Spanner Set FOAMX4 6 Pieces
4/10	TEDPC14	Punch & Chisel Set FOAM2 14 Pieces
4/10	TEDDF7	Double Flex Wrench Set FOAM2 7 Pieces
5/10	TEXPB4	Pry Bar Set Roll/Heel FOAMX4 4 Pieces
5/10	TEDADJ4	Adjustable Wrench Set FOAM2 4 Pieces
5/10	TEDIMM	Measuring Tool Set FOAM2 3 Pieces

Drawer	Item ID	Description
6/10	TEX1238	3/8" & 1/2" Torque Wrench Set FOAMX4 2 Pieces
6/10	TEXW05	Wheel Tool Set FOAMX4 5 Pieces
7/10	TTEVG11	Power Grip Plier Set FOAM4X4 11 Pieces
8/10	TTEMB17	Plier Set FOAM4X4 17 Pieces
9/10	TTEMD122N	Screwdriver Set Mixed FOAM4X4 122 Pieces
10/10	TTEX23N	Nut Driver T-Handle Set FOAM4X4 23 Pieces
1/9	TTESK86	1/4" & 3/8" Socket Set FOAM4X4 86 Pieces
1/9	TTESK63	1/2" Socket Set 12 pt FOAM4X4 63 Pieces
2/9	TTESK85	1/4", 3/8" & 1/2" Socket Set FOAM4X4 85 Pieces
3/9	TTEPS12	General Tool Set FOAM4X4 12 Pieces
4/9	TTESP37	Spanner Set FOAM4X4 37 Pieces
5/9	TTESP31	Combination Spanner Set FOAM4X4 31 Pieces
6/9	TTEAF62	Socket & Spanner Set AF FOAM4X4 62 Pieces
7/9	TTEISK73	3/8" & 1/2" Impact Socket Set FOAM4X4 73 Pieces
8/9	TTESK32	3/4" Socket Set FOAM4X4 32 Pieces
9/9	TTEISK33	3/4" Impact Socket Set DIN FOAM4X4 33 Pieces

Item ID: TCEMM1117N



FOAM Series | Tool Kits

FOAM SERIES



37" PRO STACK FOAM TOOL KIT 846 PIECES

- A complete tool kit covering the requirements of most users
- All the tools are laid out in three coloured pre-cut foam modules with each tool having its own place
- Contrasting colour clearly show if any tools are not in their correct place to prevent losing tools or leaving them in the work piece
- The kit contains 36 pre-cut foam modules containing 846 individual pieces
- Supplied in a red TengTools 37" 12 drawer stack system with a 5 drawer full depth top box and 7 drawer roller cabinet
- All in TengTools red with the distinctive TengTools eyes logo on the drop front on the top box and on the bottom drawer on the cabinet

- 12 Drawer**
- 37" Wide Cabinet**
- Heavy Gauge Steel**
- 5-Step Rust Protection**
- 5" Castor Wheels with Brakes**
- 3 Step Ball Bearing Slides**
- Comfort Grip Handle**
- Combination Lock**

**846** Pieces 230.6 kg



Drawer 1/5



Drawer 2/5

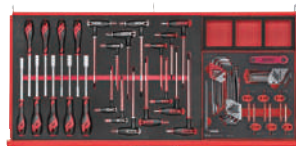

Drawer 3/5



Drawer 4/5



Drawer 5/5

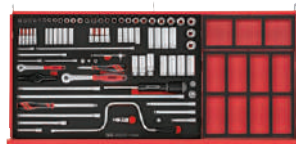

Drawer 1/7



Drawer 2/7



Drawer 3/7



Drawer 4/7

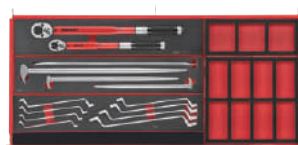

Drawer 5/7



Drawer 6/7



Drawer 7/7

Drawer	Item ID	Description
Storage	TC205NF	37" PRO Top Box 5 Drawers Red
	TCW207N	37" PRO Cabinet 7 Drawers Red
	TCF04	Tool Box Fixing Brackets for 37" Top Box
1/5	TEZ01	Storage Tray FOAMX2 3 Compartments
1/5	TTEMB17	Plier Set FOAM4X4 17 Pieces
1/5	TEDV440	Insulated Plier Set FOAM2 4 Pieces
2/5	TEZ01	Storage Tray FOAMX2 3 Compartments
2/5	TTEAF62	Socket & Spanner Set AF FOAM4X4 62 Pieces
2/5	TEAHR81	Rivet Gun Set FOAM1 81 Pieces
2/5	TEAVSD09	1000v Torque Screwdriver Set FOAM1 9 Pieces
3/5	TEZ01	Storage Tray FOAMX2 3 Compartments
3/5	TTEX23N	Nut Driver T-Handle Set FOAM4X4 23 Pieces
3/5	TEDHT42	Ball Point Hex & TX Key Set FOAM2 42 Pieces
4/5	TEZ01	Storage Tray FOAMX2 3 Compartments
4/5	TTEMD122N	Screwdriver Set Mixed FOAM4X4 122 Pieces
4/5	TEDV909N	1000v Screwdriver Set Mixed FOAM2 9 Pieces
5/5	TEZ01	Storage Tray FOAMX2 3 Compartments
5/5	TTEPS12	General Tool Set FOAM4X4 12 Pieces
5/5	TEDIMM	Measuring Tool Set FOAM2 3 Pieces

Drawer	Item ID	Description
1/7	TEZ01	Storage Tray FOAMX2 3 Compartments
1/7	TTESK86	1/4" & 3/8" Socket Set FOAM4X4 86 Pieces
1/7	TED01	Storage Tray FOAM2 8 Compartments
2/7	TEZ01	Storage Tray FOAMX2 3 Compartments
2/7	TTESK63	1/2" Socket Set 12 pt FOAM4X4 63 Pieces
2/7	TEDDF7	Double Flex Wrench Set FOAM2 7 Pieces
3/7	TEZ01	Storage Tray FOAMX2 3 Compartments
3/7	TTESK85	1/4", 3/8" & 1/2" Socket Set FOAM4X4 85 Pieces
3/7	TEDSD14	Torque Screwdriver Set FOAM2 95 Pieces
4/7	TEZ01	Storage Tray FOAMX2 3 Compartments
4/7	TTESP31	Combination Spanner Set FOAM4X4 31 Pieces
4/7	TED6512R	Ratcheting Spanner Set R FOAM2 12 Pieces
5/7	TEZ01	Storage Tray FOAMX2 3 Compartments
5/7	TEX1238	3/8" & 1/2" Torque Wrench Set FOAMX4 2 Pieces
5/7	TEXPB4	Pry Bar Set Roll/Heel FOAMX4 4 Pieces
5/7	TEX6308	Double Ring Spanner Set FOAMX4 8 Pieces
5/7	TED01	Storage Tray FOAM2 8 Compartments
7/7	TEZ01	Storage Tray FOAMX2 3 Compartments
7/7	TTESK32	3/4" Socket Set FOAM4X4 32 Pieces
7/7	TED9121	1/2" Impact Socket Set ANSI FOAM2 21 Pieces

Item ID: **TCMME846N**

**NEW**  
**FOAM**  
**SERIES**



**26" PRO STACK FOAM TOOL KIT 530 PIECES**

- A complete tool kit covering the requirements of most Industrial and Heavy Vehicles users
- Impact sockets standard and deep from 8-19 mm with 3/8" Drive, 8-36mm with 1/2" Drive and 19-46mm with 3/4" Drive
- 72 teeth spanners with 1/4", 3/8", 1/2", 3/4" Drives with sockets from 4mm up to 50mm
- Combination Spanners, Ratcheting Spanners and Double ended spanners in sizes from 5.5 to 38mm
- 25 different types of screwdrivers and a mixed selection of different bits in 25 and 50mm length together with a ratcheting bit driver
- A set with nut drivers in sizes from 5.5 to 13mm and T-handles in both hex 2.5 to 8mm and TX/TP from 10 to 40
- 14 different pliers that will cover most application. Vinyl grips for slim design allows for greater access in tight places
- 11 different power grips that will cover most applications
- All the Tools are laid out in three colour pre-cut high-density EVA foam modules with each tool having its own place
- Clearly shows if any tools are not in their correct place to prevent losing tools or leaving them in the work piece
- Supplied in the TengTools TC805NFX full depth 5 drawer top box and TCW807N 7 drawer roller cabinet

**530** Pieces 201.5 kg



Drawer 1/5



Drawer 2/5



Drawer 3/5



Drawer 4/5

- 11** Drawer
- 5"** Castor Wheels with Brakes
- 26"** Wide Cabinet
- 3** Step Ball Bearing Slides
- Heavy Gauge Steel**
- Comfort Grip Handle**
- 5-Step Rust Protection**
- Combination Lock**



Drawer 5/5

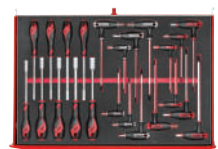

Drawer 1/7



Drawer 2/7

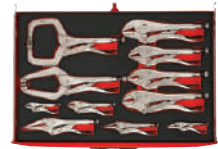

Drawer 3/7



Drawer 4/7

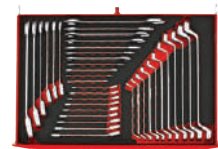

Drawer 5/7



Drawer 6/7



Drawer 7/7

Drawer	Item ID	Description
Storage	TC805NFX	26" PRO Full Depth Top Box 5 Drawers Red
	TCW807N	26" PRO Cabinet 7 Drawers Red
1/5	TTESK86	1/4" & 3/8" Socket Set FOAM4X4 86 Pieces
2/5	TTEISK73	3/8" & 1/2" Impact Socket Set FOAM4X4 73 Pieces
3/5	TTESK63	1/2" Socket Set 12 pt FOAM4X4 63 Pieces
4/5	TTEISK33	3/4" Impact Socket Set DIN FOAM4X4 33 Pieces
5/5	TTESK32	3/4" Socket Set FOAM4X4 32 Pieces
1/6	TTEX23N	Nut Driver T-Handle Set FOAM4X4 23 Pieces
2/6	TTESP31	Combination Spanner Set FOAM4X4 31 Pieces
3/6	TTEVG11	Power Grip Plier Set FOAM4X4 11 Pieces
4/6	TTEMD122N	Screwdriver Set Mixed FOAM4X4 122 Pieces
5/6	TTESP37	Spanner Set FOAM4X4 37 Pieces
6/6	TTEMB14Q	Plier Set Vinyl Grip Q FOAM4X4 14 Pieces

Item ID: **TCMME09AQ**

**26" PRO STACK FOAM TOOL KIT 417 PIECES**

- A complete tool kit covering the requirements of most users
- All the tools are laid out in three colour pre-cut high-density EVA foam modules with each tool having it's own place
- Clearly shows if any tools are not in their correct place to prevent losing tools or leaving them in the work piece
- Supplied in a red TengTools 26" 6 drawer top box and a red TengTools 26" 7 drawer roller cabinet
- A comprehensive selection of tools using 7 of the available 13 drawers ensuring that space is still available to add to the kit if needed

**417** Pieces **138.3** kg

- 13** Drawer
- 26"** Wide Cabinet
- Heavy Gauge Steel**
- 5-Step Rust Protection**
- 5"** Castor Wheels with Brakes
- 3 Step Ball Bearing Slides**
- Comfort Grip Handle**
- Combination Lock**



Drawer 1, 2, 3/6



Drawer 4/6



Drawer 5/6



Drawer 6/6



Drawer 1/7



Drawer 2/7

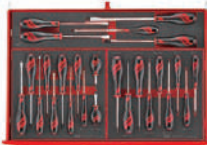

Drawer 3/7



Drawer 4/7



Drawer 5/7



Drawer 6/7



Drawer 7/7



Drawer	Item ID	Description
Storage	TC806NF	26" PRO Top Box 6 Drawers Red
	TCW807N	26" PRO Cabinet 7 Drawers Red
6/6	TEDHEX7	T-Handle Ball Point Hex Key Set FOAM2 7 Pieces
6/6	TEDTX7	T-Handle Ball Point TX Key Set FOAM2 7 Pieces
1/7	TEXEXT13	Extension Bars Set FOAMX4 13 Pieces
1/7	TED1489	1/4" Socket Set 6 pt FOAM2 89 Pieces
1/7	TED3836	3/8" Socket Set 6 pt FOAM2 36 Pieces
2/7	TEX1238	3/8" & 1/2" Torque Wrench Set FOAMX4 2 Pieces
2/7	TED1227	1/2" Socket Set 12 pt FOAM2 27 Pieces
2/7	TED441-T	Plier Set TPR Grip FOAM2 5 Pieces
3/7	TEX915N	Screwdriver Set Flat & PH FOAMX4 5 Pieces
3/7	TED911N	Screwdriver Set Mixed FOAM2 11 Pieces
3/7	TED909TXN	Screwdriver Set TX FOAM2 9 Pieces
4/7	TEXPB4	Pry Bar Set Roll/Heel FOAMX4 4 Pieces
4/7	TEDSD14	Torque Screwdriver Set FOAM2 95 Pieces
4/7	TEDPC14	Punch & Chisel Set FOAM2 14 Pieces
5/7	TEX2032	Combination Spanner Set FOAMX4 7 Pieces
5/7	TED8012	Spanner Set Anti Slip FOAM2 12 Pieces
5/7	TEDAD34	Adjustable Wrench Set FOAM2 4 Pieces
6/7	TEXW05	Wheel Tool Set FOAMX4 5 Pieces
6/7	TED9121	1/2" Impact Socket Set ANSI FOAM2 21 Pieces
6/7	TEDHT42	Ball Point Hex & TX Key Set FOAM2 42 Pieces

Item ID: **TCEMM417N**



# FOAM Series | Tool Kits

FOAM SERIES



249 Pieces 114 kg

Drawer	Item ID	Description
Storage	TC806NF	26" PRO Top Box 6 Drawers Red
	TCW807N	26" PRO Cabinet 7 Drawers Red
5/6	TEDV440	Insulated Plier Set FOAM2 4 Pieces
5/6	TEDV909N	Insulated Screwdriver Set Mixed FOAM2 9 Pieces
6/6	TEDHEX7	T-Handle Ball Point Hex Key Set FOAM2 7 Pieces
6/6	TEDTX7	T-Handle Ball Point TX Key Set FOAM2 7 Pieces
1/7	TEXEXT13	Extension Bars Set FOAMX4 13 Pieces
1/7	TED1489	1/4" Socket Set 6 pt FOAM2 89 Pieces
1/7	TED3836	3/8" Socket Set 6 pt FOAM2 36 Pieces
2/7	TEX1238	3/8" & 1/2" Torque Wrench Set FOAMX4 2 Pieces
2/7	TED1227	1/2" Socket Set 12 pt FOAM2 27 Pieces
2/7	TED441-T	Plier Set TPR Grip FOAM2 5 Pieces
3/7	TEX915N	Screwdriver Set Flat & PH FOAMX4 5 Pieces
3/7	TED911N	Screwdriver Set Mixed FOAM2 11 Pieces
3/7	TED909TXN	Screwdriver Set TX FOAM2 9 Pieces
4/7	TEX2032	Combination Spanner Set FOAMX4 7 Pieces
4/7	TED8012	Spanner Set Anti Slip FOAM2 12 Pieces
4/7	TEDAD34	Adjustable Wrench Set FOAM2 4 Pieces

Item ID: TCEMM249N

## 26" PRO STACK FOAM TOOL KIT 249 PIECES

- A complete tool kit covering the requirements of most users
- All the tools are laid out in three colour pre-cut high-density EVA foam modules with each tool having it's own place
- Clearly shows if any tools are not in their correct place to prevent losing tools or leaving them in the work piece
- Supplied in a red TengTools 26" 7 drawer top box and a red TengTools 26" 7 drawer roller cabinet
- A comprehensive selection of tools using 6 of the available 13 drawers ensuring that space is still available to add to the kit if needed

- 13 Drawer
- 26" Wide Cabinet
- Heavy Gauge Steel
- 5-Step Rust Protection
- 5" Castor Wheels with Brakes
- 3 Step Ball Bearing Slides
- Comfort Grip Handle
- Combination Lock



Drawer 1, 2, 3/6



Drawer 4/6



Drawer 5/6



Drawer 6/6



Drawer 1/7



Drawer 2/7



Drawer 3/7



Drawer 4/7



Drawer 5/7

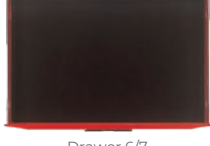

Drawer 6/7

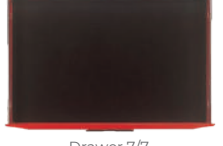

Drawer 7/7

Miss Marsden Cove 'TengTools' is a Grand Prix hydroplane powered by a 468 cubic inch Chev reaching speeds of 273 km (170mph) the fastest automotive powered boats on the water in the world.



FOAM Series | Tool Kits

FOAM SERIES



37" PRO CABINET FOAM TOOL KIT 631 PIECES

- A complete tool kit covering the requirements of most users
- All the tools are laid out in three colour pre-cut high-density EVA foam modules with each tool having it's own place
- Clearly shows if any tools are not in their correct place to prevent losing tools or leaving them in the work piece
- Supplied in a red TengTools 37" 7 drawer roller cabinet
- A comprehensive selection of tools using 6 of the available 7 drawers ensuring that space is still available to add to the kit if needed

- 7 Drawer
- 37" Wide Cabinet
- Heavy Gauge Steel
- 5-Step Rust Protection
- 5" Castor Wheels with Brakes
- 3 Step Ball Bearing Slides
- Comfort Grip Handle
- Combination Lock

631 Pieces 138 kg



Drawer 1/7



Drawer 2/7



Drawer 3/7

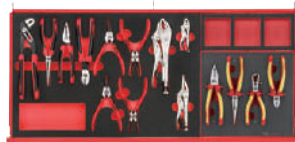

Drawer 4/7



Drawer 5/7



Drawer 6/7



Drawer 7/7

Drawer	Item ID	Description
Storage	TCW207N	37" PRO Cabinet 7 Drawers Red
	TC-TB03	Work Top for 37" Cabinet
1/7	TTESK77	1/4", 3/8" & 1/2" Socket Set FOAM4X4 77 Pieces
1/7	TEDHT42	Ball Point Hex & TX Key Set FOAM2 42 Pieces
1/7	TEZ01	Storage Tray FOAMX2 3 Compartments
2/7	TTEX32	Spanner & File Set FOAM4X4 32 Pieces
2/7	TEDDF7	Double Flex Wrench Set FOAM2 7 Pieces
2/7	TEZ01	Storage Tray FOAMX2 3 Compartments
3/7	TTEMD122N	Screwdriver Set Mixed FOAM4X4 122 Pieces
3/7	TEDV909N	Insulated Screwdriver Set Mixed FOAM2 9 Pieces
3/7	TEZ01	Storage Tray FOAMX2 3 Compartments
4/7	TTEMB11	Plier Set FOAM4X4 11 Pieces
4/7	TEDV440	Insulated Plier Set FOAM2 4 Pieces
4/7	TEZ01	Storage Tray FOAMX2 3 Compartments
5/7	TTESK85	1/4", 3/8" & 1/2" Socket Set FOAM4X4 85 Pieces
5/7	TEDSD14	Torque Screwdriver Set FOAM2 95 Pieces
5/7	TEZ01	Storage Tray FOAMX2 3 Compartments
6/7	TTEPS12	General Tool Set FOAM4X4 12 Pieces
6/7	TEAHR81	Rivet Gun Set FOAM1 81 Pieces
6/7	TEABS50	Impact Bit Set FOAM1 50 Pieces
6/7	TEZ01	Storage Tray FOAMX2 3 Compartments

Item ID: **TCEMM631N**



FOAM Series | Tool Kits

FOAM SERIES



- 7 Drawer**
- 26" Wide Cabinet**
- Heavy Gauge Steel**
- 5-Step Rust Protection**
- 5" Castor Wheels with Brakes**
- 3 Step Ball Bearing Slides**
- Comfort Grip Handle**
- Combination Lock**

**333** Pieces 91.5 kg

**26" PRO CABINET FOAM TOOL KIT 333 PIECES**

- A complete tool kit covering the requirements of most users
- All the tools are laid out in three colour pre-cut high-density EVA foam modules with each tool having it's own place
- Clearly shows if any tools are not in their correct place to prevent losing tools or leaving them in the work piece
- Supplied in a red TengTools 26" 7 drawer roller cabinet

Drawer	Item ID	Description
Storage	TCW807N	26" PRO Cabinet 7 Drawers Red
1/7	TTEMB11	Plier Set FOAM4X4 11 Pieces
2/7	TTEMD98N	Screwdriver Set Mixed FOAM4X4 98 Pieces
3/7	TTEPS12	General Tool Set FOAM4X4 12 Pieces
4/7	TTESK85	1/4", 3/8" & 1/2" Socket Set FOAM4X4 85 Pieces
5/7	TTESK77	1/4", 3/8" & 1/2" Socket Set FOAM4X4 77 Pieces
6/7	TTEX17	General Tool Set FOAM4X4 17 Pieces
7/7	TTEX32	Spanner & File Set FOAM4X4 32 Pieces

Item ID: **TCMME11A**



Drawer 1/7



Drawer 2/7



Drawer 3/7



Drawer 4/7



Drawer 5/7



Drawer 6/7

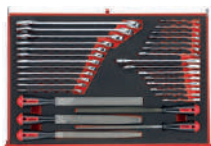

Drawer 7/7

**26" PRO CABINET FOAM TOOL KIT 280 PIECES**

- A complete tool kit covering the requirements of most types of users
- 72 teeth spanners with 1/4", 3/8" Drives with sockets from 4mm up to 22mm
- Combination Spanners from 5.5 to 38mm
- 25 different types of screwdrivers and a mixed selection of different bits in 25 and 50mm length together with a ratcheting bit driver
- A set with nut drivers in sizes from 5.5 to 13mm and T-handles in both hex 2.5 to 8mm and TX/TP from 10 to 40
- 14 different pliers that will cover most application. Vinyl grips for slim design allows for greater access in tight places
- All the Tools are laid out in three colour pre-cut high-density EVA foam modules with each tool having its own place
- Clearly shows if any tools are not in their correct place to prevent losing tools or leaving them in the work piece
- Supplied in a red TengTools 26" 7 drawer roller cabinet
- A comprehensive selection of tools using 5 of the available 7 drawers ensuring that space is still available to add to the kit if needed.

**NEW**  
FOAM  
SERIES



**280**  
Pieces 87.7 kg

- 7 Drawer**
- 26" Wide Cabinet**
- Heavy Gauge Steel**
- 5-Step Rust Protection**
- 5" Castor Wheels with Brakes**
- 3 Step Ball Bearing Slides**
- Comfort Grip Handle**
- Combination Lock**

Drawer	Item ID	Description
Storage	TCW807N	26" PRO Cabinet 7 Drawers Red
1/7	TTESK86	1/4" & 3/8" Socket Set FOAM4X4 86 Pieces
2/7	TTEX23N	Nut Driver T-Handle Set FOAM4X4 23 Pieces
3/7	TTESP31	Combination Spanner Set FOAM4X4 31 Pieces
4/7	TTEMB14Q	Plier Set Vinyl Grip Q FOAM4X4 14 Pieces
5/7	TTEMD122N	Screwdriver Set Mixed FOAM4X4 122 Pieces

Item ID: TCMME09CQ



Drawer 1/7

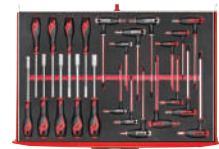

Drawer 2/7



Drawer 3/7



Drawer 4/7



Drawer 5/7



Drawer 6/7



Drawer 7/7

# FOAM Series | Tool Kits

**FOAM**  
SERIES



- 7 Drawer**
- 26" Wide Cabinet**
- Heavy Gauge Steel**
- 5-Step Rust Protection**
- 5" Castor Wheels with Brakes**
- 3 Step Ball Bearing Slides**
- Key Lock**

**179**  
PIECES 69 kg

## 26" STD CABINET FOAM TOOL KIT 179 PIECES

- All the tools are laid out in three colour pre-cut high-density EVA foam modules with each tool having it's own place
- Clearly shows if any tools are not in their correct place to prevent losing tools or leaving them in the work piece
- Supplied in a red TengTools 26" 7 drawer standard roller cabinet
- A comprehensive selection of tools using just 3 of the available 7 drawers ensuring that space is still available to add to the kit if needed

Drawer	Item ID	Description
Storage	TCW707EV	26" STD Cabinet 7 Drawers Red
1/7	TTEPS25	General Tool Set FOAM4X4 25 Pieces
2/7	TTESK126	1/4" & 1/2" Socket Set 6 pt FOAM4X4 126 Pieces
3/7	TTESP28	General Tool Set FOAM4X4 28 Pieces

Item ID: **TCMME179**



Drawer 1/7



Drawer 2/7



Drawer 3/7



Drawer 4/7



Drawer 5/7



Drawer 6/7



Drawer 7/7



**26" STD CABINET FOAM TOOL KIT 174 PIECES**

- All the tools are laid out in three colour pre-cut high-density EVA foam modules with each tool having its own place
- Clearly shows if any tools are not in their correct place to prevent losing tools or leaving them in the work piece
- Supplied in a red TengTools 26" 7 drawer standard roller cabinet with ABS top
- A comprehensive selection of tools using just 3 of the available 7 drawers ensuring that plenty of space is still available

Drawer	Item ID	Description
Storage	TCW707EV	26" STD Cabinet 7 Drawers Red
	ABS-TOP	ABS Top for 26" Cabinet
1/7	TTESK126	1/4" & 1/2" Socket Set 6 pt FOAM4X4 126 Pieces
2/7	TTEM33	Screwdriver & Spanner Set FOAM4X4 33 Pieces
3/7	TTEPS15	General Tool Set FOAM4X4 15 Pieces

Item ID: TCMME174



FOAM SERIES

- 7 Drawer**
  - 26" Wide Cabinet**
  - Heavy Gauge Steel**
  - 5-Step Rust Protection**
  - 5" Castor Wheels with Brakes**
  - 3 Step Ball Bearing Slides**
  - Key Lock**
- 174  
Pieces

62 kg



Drawer 1/7



Drawer 2/7



Drawer 3/7



Drawer 4/7

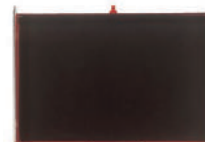

Drawer 5/7



Drawer 6/7



Drawer 7/7



FOAM Series | Tool Kits

**NEW**  
FOAM  
SERIES



183 Pieces 42 kg

- 6 Drawer**
- 26" Wide Box**
- Heavy Gauge Steel**
- 5-Step Rust Protection**
- 3 Step Ball Bearing Slides**
- Comfort Grip Handle**
- Combination Lock**



Drawer 1, 2, 3/6



Drawer 4/6



Drawer 5/6



Drawer 6/6

**26" PRO TOP BOX FOAM TOOL KIT 183 PIECES**

- A comprehensive mechanics starter kit built up using the TengTools Tool Control system
- All the tools are laid out in three colour pre-cut high-density EVA foam modules with each tool having its own place
- Clearly shows if any tools are not in their correct place to prevent losing tools or leaving them in the work piece
- Supplied in a red TengTools 26" 6 drawer top box with 3 full width drawers and 3 smaller drawers secured with a combination lock
- Drop front with the TengTools logo to cover the drawers when the box is closed.
- A handy lightweight plastic and aluminium tote tray is included for taking tools to the job in hand

Drawer	Item ID	Description
Storage	TC806NF	26" PRO Top Box 6 Drawers Red
4/6	TED1489	1/4" Socket Set 6 pt FOAM2 89 Pieces
4/6	TED3836	3/8" Socket Set 6 pt FOAM2 36 Pieces
5/6	TED1227	1/2" Socket Set 12 pt FOAM2 27 Pieces
5/6	TED8012	Spanner Set Anti Slip FOAM2 12 Pieces
6/6	TEDHEX7	T-Handle Ball Point Hex Key Set FOAM2 7 Pieces
6/6	TED911N	Screwdriver Set Mixed FOAM2 11 Pieces

Item ID: **TC183NF**



**26" PRO TOP BOX FOAM TOOL KIT 280 PIECES**

- A complete tool kit covering the requirements of most types of users that wants a Tool kit does not take up too much space and can easily place on a workbench
- 72 teeth spanners with 1/4", 3/8" Drives with sockets from 4mm up to 22mm
- Combination Spanners from 5.5 to 38mm
- 25 different types of screwdrivers and a mixed selection of different bits in 25 and 50mm length together with a ratcheting bit driver
- A set with nut drivers in sizes from 5.5 to 13mm and T-handles in both hex 2.5 to 8mm and TX/TP from 10 to 40
- 14 different pliers that will cover most application. Vinyl grips for slim design allows for greater access in tight places
- All the Tools are laid out in three colour pre-cut high-density EVA foam modules with each tool having its own place
- Clearly shows if any tools are not in their correct place to prevent losing tools or leaving them in the work piece
- Supplied in a red TengTools 26" full depth 5 drawer top box
- Clearly shows if any tools are not in their correct place to prevent losing tools or leaving them in the work piece
- Supplied in the TengTools TC805NFX full depth 5 drawer top box and TCW807N 7 drawer roller cabinet



FOAM SERIES

- 5 Drawer**
- 26" Wide Cabinet**
- Heavy Gauge Steel**
- 5-Step Rust Protection**
- 3 Step Ball Bearing Slides**
- Comfort Grip Handle**
- Combination Lock**

**280** Pieces 67.8 kg

Drawer	Item ID	Description
Storage	TC805NFX	26" PRO Full Depth Top Box 5 Drawers Red
1/5	TTESK86	1/4" & 3/8" Socket Set FOAM4X4 86 Pieces
2/5	TTEX23N	Nut Driver T-Handle Set FOAM4X4 23 Pieces
3/5	TTESP31	Combination Spanner Set FOAM4X4 31 Pieces
4/5	TTEMB14Q	Plier Set Vinyl Grip Q FOAM4X4 14 Pieces
5/5	TTEMD122N	Screwdriver Set Mixed FOAM4X4 122 Pieces



Drawer 1/5

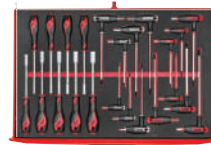

Drawer 2/5



Drawer 3/5

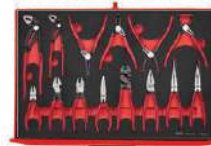

Drawer 4/5



Drawer 5/5

Item ID: **TCMME09BQ**

MECCA PRO™

FOAM SERIES



118 Pieces 11.8 kg



MECCA PRO TC-9 FOAM TOOL KIT 118 PIECES

- Supplied in the unique TengTools service case with the tools supplied in 3 FOAM3 sets especially designed to fit the service case
- Tools are held in place using three colour pre-cut high-density EVA foam clearly showing where each tool belongs
- Hard wearing flight case style carrying case with a combination lock and secure catches
- Complete with fixed castor wheels and retractable handle for easy carrying

Section	Item ID	Description
1/3	TEFMD54	Screwdriver, Hex Key & MM Tape FOAM3 54 Pieces
2/3	TEFMB7	General Tool Set Carpenters Hammer FOAM3 7 Pieces
3/3	TEFSK57	Spanner & Socket Set FOAM3 57 Pieces

Item ID: SCE1

MECCA PRO™

FOAM SERIES



118 Pieces 12 kg



MECCA PRO TC-9 FOAM BP TOOL KIT 118 PIECES

- Supplied in the unique TengTools service case with the tools supplied in 3 FOAM3 sets especially designed to fit the service case
- Tools are held in place using three colour pre-cut high-density EVA foam clearly showing where each tool belongs
- Hard wearing flight case style carrying case with a combination lock and secure catches
- Complete with fixed castor wheels and retractable handle for easy carrying

Section	Item ID	Description
1/3	TEFMDI54	Screwdriver, Hex Key & MM/AF Tape FOAM3 54 Pieces
2/3	TEFMBP7	General Tool Set Ball Pein Hammer FOAM3 7 Pieces
3/3	TEFSK57	Spanner & Socket Set FOAM3 57 Pieces

Item ID: SCE2

**MECCA PRO™**  
**FOAM**  
SERIES



**112**  
Pieces

**MECCA PRO TC-6 FOAM TOOL KIT 112 PIECE**

- Supplied in the unique TengTools service case with the tools supplied in 2 FOAM3 sets.
- Tools held in place using three colour pre-cut high-density EVA foam clearly showing where each tool belongs.
- Hard wearing carrying case with distinctive branding.
- Robust moulded body with built in strength and durability.
- Handle on side make it easy to carry

Section	Item ID	Description
1/2	TEFMDI54	Screwdriver, Hex Key & MM/AF Tape FOAM3 54 Pieces
2/2	TEFSK57	Spanner & Socket Set FOAM3 57 Pieces

Item ID: **TC-6TE01**

**NEW**

**MECCA PRO™**  
**FOAM**  
SERIES



**29**  
Pieces

**MECCA PRO TC-6 FOAM ELECTRICIAN TOOL KIT 29 PIECES**

- Includes pliers, torque screwdriver, storage and screwdrivers
- Tools are held in place by our three coloured Foam system, will clearly alerts the user when a tool is out of place
- Insulated tools for live working up to 1,000 volts
- Integrated protective insulation with two colour s to clearly indicate if there is any damage
- All tools are laid out in three colour pre-cut high-density EVA foam modules, clearly shows if any tools are not in their correct place
- Supplied in the unique TengTools service case with the tools supplied in 6 TengTools TT modules
- Nonslip rubber feet to prevent the case from sliding and which protects against scratching
- Secure lock system with click mechanism so you know the top is closed properly
- Hard wearing hinge with metal pin for increased life
- Retractable handle design for comfort and durability

Section	Item ID	Description
1/2	TEDV909N	Insulated Screwdriver Set Mixed FOAM2
2/2	TEAVSD09	Insulated Torque Screwdriver Set FOAM1 9 Pieces
2/2	TEDV440	Insulated Plier Set FOAM2 4 Pieces
2/2	TEA01	Storage Tray FOAM1 7 Compartments

Item ID: **TC-6TE02**

# FOAM SERIES TOOL TRAYS

A modular system that fits all storages

Our tool sets are available in different sizes (1-4 and X2-X4). These can be combined to fit perfectly into your chosen storage solution, regardless of whether you have a storage that is portable, 26, 37 or 53 inches.

## 1 CHOOSE YOUR STORAGE

Storages for all needs.



## 2 CHOOSE YOUR TOOL SETS

Your kit. Your way.



## 3 ORGANISE YOUR KIT

Optimise your workflow.



A flexible tool control system with over 240 tool sets

The Foam Series offers the ultimate tool organisation. Each tool has its own place with its description imprinted in the 3-coloured foam. The contrast colours makes it easy to identify tools and see when a tool is missing. The high quality foam stays soft and flexible even in cold environments and gives the tool kit a premium look.

**TT  
SERIES**  
SIZE



Portable Service case



26" Top & Middle box drawer



26" cabinet drawer



37" cabinet drawer

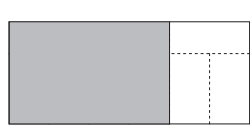
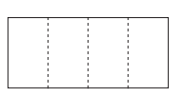
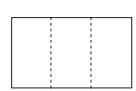
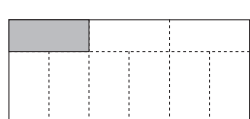
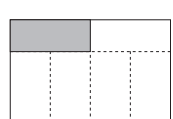
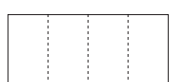
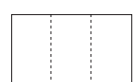
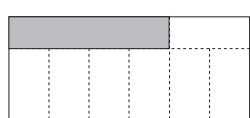
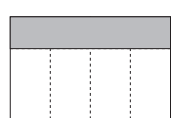
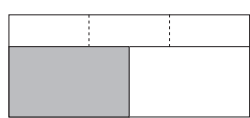
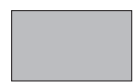
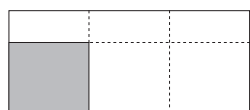
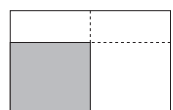
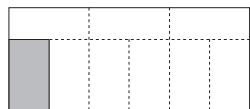
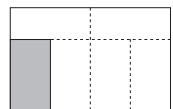
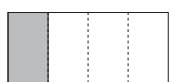
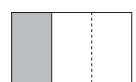
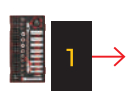

FOAM Series | Tool Trays

STORAGE TRAYS



STORAGE TRAY FOAM1 7 COMPARTMENTS

- Storage module with 7 compartments
- three colour pre-cut high-density EVA foam
- Ideal for storing small items as part of a tool kit or work station
- Removable lid and dove tail joints
- Organised in a foam inlay module size 1 (FOAM1)

Item ID: TEA01



STORAGE TRAY FOAM1 2 COMPARTMENTS

- Storage module with 2 compartments
- three colour pre-cut high-density EVA foam
- Ideal for storing small items as part of a tool kit or work station
- Removable lid and dove tail joints
- Organised in a foam inlay module size 1 (FOAM1)

Item ID: TEA02



STORAGE TRAY FOAM2 4 COMPARTMENTS

- Storage module with 4 compartments
- three colour pre-cut high-density EVA foam
- Ideal for storing small items as part of a tool kit or work station
- Removable lid and dove tail joints
- Organised in a foam inlay module size 2 (FOAM2)

Item ID: TED00



STORAGE TRAY FOAM2 8 COMPARTMENTS

- Storage module with 8 compartments
- three colour pre-cut high-density EVA foam
- Ideal for storing small items as part of a tool kit or work station
- Removable lid and dove tail joints
- Organised in a foam inlay module size 2 (FOAM2)

Item ID: TED01

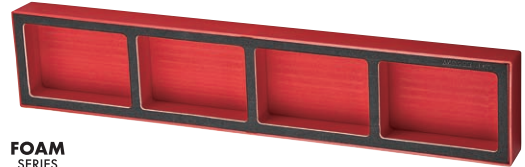

STORAGE TRAY FOAMX4 4 COMPARTMENTS

- Storage module with 4 compartments
- three colour pre-cut high-density EVA foam
- Ideal for storing small items as part of a tool kit or work station
- Organised in a foam inlay module size X4 (FOAMX4)

Item ID: TEX02



STORAGE TRAY FOAMX2 3 COMPARTMENTS

- Storage module with 3 compartments
- three colour pre-cut high-density EVA foam
- Ideal for storing small items as part of a tool kit or work station
- Organised in a foam inlay module size X2 (FOAMX2)

Item ID: TEZ01

GENERAL TOOL KITS



FOAM SERIES  
3

7 Pieces

GENERAL TOOL SET FOAM3 7 PIECES

- Includes pliers, adjustable wrench, knife, tin snips and a claw hammer
- Tools are held in place using three colour pre-cut high-density EVA foam
- Designed to fit exactly in the TengTools service cases
- Organised in a foam inlay module size 3 (FOAM3)

General Tools:	
TPR Grip Pliers:	6" side cutters, 8" long nose pliers, 10" quick set water pump pliers
Wrenches	8" wide jaw adjustable wrench
Cutting Tools:	Utility knife, straight cut high leverage tin snips
Hammers:	16 oz claw hammer

Item ID: TEFMB7



FOAM SERIES  
3

7 Pieces

GENERAL TOOL SET BP FOAM3 7 PIECES

- Includes pliers, adjustable wrench, knife, tin snips and a ball pein hammer
- Tools are held in place using three colour pre-cut high-density EVA foam
- Designed to fit exactly in the TengTools service cases
- Organised in a foam inlay module size 3 (FOAM3)

General Tools:	
TPR Grip Pliers:	6" side cutters, 8" long nose pliers, 10" quick set water pump pliers
Wrenches	8" wide jaw adjustable wrench
Cutting Tools:	Utility knife, straight cut high leverage tin snips
Hammers:	16 oz ball pein hammer

Item ID: TEFMBP7

NEW



FOAM SERIES  
3

7 Pieces

PLIER AND ENGINEER HAMMER SET 7 PIECES

- Includes pliers, adjustable wrench, knife, tin snips and an engineer's hammer
- Tools are hold in place using three colour pre-cut high-density EVA foam
- Design to fit exactly in the TengTools service cases

General Tools:	
Pliers:	6" TPR grip side cutters , 8" TPR grip long nose pliers, 10" Vinyl grip quick set water pump pliers
Wrenches	8" wide jaw adjustable wrench
Cutting Tools:	Utility knife, straight cut high leverage tin snips
Hammers:	500g Engineers Hammer

Item ID: TEFMBP7E

NEW



FOAM SERIES  
3

6 Pieces

GENERAL TOOL SET BP FOAM3 6 PIECES

- Includes plier, adjustable wrench, knives, saw and a ball pein hammer
- Tools are hold in place using three colour pre-cut high-density EVA foam clearly showing where each tool belongs
- Design to fit exactly in the TengTools service cases
- Organised in a foam inlay module size 3 (FOAM3)

General Tools:	
Pliers:	10" Vinyl grip quick set water pump pliers
Wrenches	8" wide jaw adjustable wrench
Cutting Tools:	Utility knife, Hacksaw blade holder, Snap off knife with 9mm blade
Hammers:	16 oz ball pein hammer

Item ID: TEFX06



## FOAM Series | Tool Trays



**FOAM SERIES**  
3

6 Pieces

### GENERAL TOOL SET E FOAM3 6 PIECES

- Includes plier, adjustable wrench, knives, saw and an engineer's hammer
- Tools are hold in place using three colour pre-cut high-density EVA foam clearly showing where each tool belongs
- Design to fit exactly in the TengTools service cases
- Organised in a foam inlay module size 3 (FOAM3)

General Tools:	
Pliers:	10" Vinyl grip quick set water pump pliers
Wrenches	8" wide jaw adjustable wrench
Cutting Tools:	Utility knife, Hacksaw blade holder, Snap off knife with 9mm blade
Hammers:	500g Engineers Hammer

Item ID: **TEFX06E**



**FOAM SERIES**  
3

7 Pieces

### PLUMBER TOOL SET FOAM3 7 PIECES

- Includes plier, adjustable wrench, knives, saw, vernier caliper, spirit level, pipe cutter and a deburring tool
- Tools are hold in place using three colour pre-cut high-density EVA foam clearly showing where each tool belongs
- Design to fit exactly in the TengTools service cases
- Organised in a foam inlay module size 3 (FOAM3)

General Tools:	
Pliers:	10" Vinyl grip quick set water pump pliers
Wrenches	8" wide jaw adjustable wrench
Measuring Tools:	Torpedo spirit level 230mm, Vernier Caliper 150mm
Cutting Tools:	Hacksaw blade holder, Pipe cutter 3-32mm, Deburring tool

Item ID: **TEFX07**



**FOAM SERIES**  
3

7 Pieces

### ELECTRICIAN TOOL SET FOAM3 7 PIECES

- Includes insulated pliers, cable tie gun, voltage tester, crimping plier, stripping plier and a scissor
- Tools are hold in place using three colour pre-cut high-density EVA foam clearly showing where each tool belongs
- Design to fit exactly in the TengTools service cases
- Organised in a foam inlay module size 3 (FOAM3)

General Tools:	
1000V Pliers:	6" Insulated side cutters, 8" Insulated long nose pliers
Wiring Tools	Ratcheting crimping plier, Ratcheting wire stripping plier, Cable tie gun, Electricians scissors, Voltage tester

Item ID: **TEFX07A**



**FOAM SERIES**  
4x4

25 Pieces

### GENERAL TOOL SET FOAM4X4 25 PIECES

- Includes measuring, striking and cutting tools as well as all the most commonly used pliers
- Tools are held in place using three colour pre-cut high-density EVA foam
- Designed to fit exactly in the larger TengTools tool box drawers
- Organised in a foam inlay module size 4X4 (FOAM4X4)

General Tools:	
Cutting Tools:	12" hacksaw, craft knife with 10 spare 18mm snap off blades
Striking Tools:	Soft face hammer, 500g engineers style hammer, parallel pin punches (3, 4, 5, 6, 7, 8mm)
Pliers:	6" heavy duty side cutters, 7" high leverage combination pliers, 6" long nose pliers, 10" water pump pliers
Measuring Tools:	3 meter measuring tape

Item ID: **TTEPS25**



FOAM SERIES  
4x4

27  
PIECES

**GENERAL TOOL SET FOAM4X4 12 PIECES**

- Includes measuring, striking and cutting tools as well as adjustable wrenches
- Tools are held in place using three colour pre-cut high-density EVA foam
- Designed to fit exactly in the larger TengTools tool box drawers
- Organised in a foam inlay module size 4X4 (FOAM4X4)

General Tools:	
Cutting Tools:	12" hacksaw, craft knife with 10 spare 18mm snap off blades
Striking Tools:	800gm engineers hammer, soft face hammer, cold chisels (150x18mm, 200x25mm), 150x5mm centre punch, parallel pin punches (3, 4, 5, 6, 7, 8mm)
Wrenches	6" and 10" adjustable wrenches
Measuring Tools:	3 meter measuring tape, 200mm steel rule

Item ID: **TTEPS12**



FOAM SERIES  
4x4

28  
PIECES

**GENERAL TOOL SET FOAM4X4 28 PIECES**

- Includes combination spanners, screwdrivers, hex keys, an adjustable wrench and a claw pick up tool
- Tools are held in place using three colour pre-cut high-density EVA foam
- Designed to fit exactly in the larger TengTools tool box drawers
- Designed and manufactured to DIN and ISO standards
- Organised in a foam inlay module size 4X4 (FOAM4X4)

Combination Spanners:	
8, 10, 11, 12, 13, 14, 15, 16, 17, 18, 19 mm	
General Tools:	
Wrenches	8" wide jaw adjustable
Ball point hex keys:	1.5, 2, 2.5, 3, 4, 5, 6, 8, 10 mm
Accessories:	600mm claw pick up tool
Screwdrivers:	⊖ 3.5x75 mm    ⊕ PH1x75 mm    ⊕ PZ1x75 mm 5.5x150 mm    PH2x100 mm    PZ2x100 mm

Item ID: **TTESP28**



FOAM SERIES  
4x4

15  
PIECES

**GENERAL TOOL SET FOAM4X4 15 PIECES**

- Includes hack saw, measuring tape, parallel pin punches well as a range of pliers with TPR grip
- Tools are held in place using three colour pre-cut high-density EVA foam
- Designed to fit exactly in the larger TengTools tool box drawers
- Organised in a foam inlay module size 4X4 (FOAM4X4)

General Tools:	
General Tools:	12" hacksaw, 3M measuring tape, Parallel Pin Punch Set
TPR Grip Pliers:	8" heavy duty side cutters, 8" heavy duty combination pliers, 8" long nose pliers, 10" water pump pliers

Item ID: **TTEPS15**

FOAM Series | Tool Trays



FOAM  
SERIES  
4X4

GENERAL TOOL SET FOAM4X4 17 PIECES

- Includes a 1/2" drive torque wrench, hex and TX keys and a selection of inspection tools
- Tools are held in place using three colour pre-cut high-density EVA foam
- Designed to fit exactly in the larger TengTools tool box drawers
- Organised in a foam inlay module size 4X4 (FOAM4X4)

T Handle Hex Keys:	
	2.5, 3, 4, 5, 6, 7, 8 mm
Hex & TX Keys:	
	1.5, 2, 2.5, 3, 4, 5, 6, 7, 8, 10 mm
	TX8, TX9, TX10, TX15, TX20, TX25, TX27, TX30, TX40
Fold Up Key Set:	
	4, 5, 6mm Hex, TX25, TX30, 5.5mm Flat, PH1, PZ2
General Tools:	
Torque Wrench:	1/2" drive, Range: 40-210Nm
Inspection Tools:	Magnifying glass & mirror (telescopic with extension up to 85cm), LED torch, Hook and pick set
Pick Up Tools	Magnetic pick up, Aluminium handle with interchangeable awl, Hook tools: 45° and 90°

Item ID: **TTEX17**

SOCKET SETS



FOAM  
SERIES  
1

87 Pieces 1/4" mm AF

1/4" SOCKET & BITS SET FOAM1 87 PIECES

- Gearless palm ratchet, accessories and a bi-flex wrench
- 1/4" drive regular 6 point sockets in metric and AF
- 1/4" drive deep 6 point sockets
- A selection of 25mm long bits
- Organised in a foam inlay module size 1 (FOAM1)

Gearless palm ratchet, 3" extension bar, 1/4"M x 1/4"Hex adaptor, Bi Flex wrench	
6 point sockets:	
	Reg mm: 5.5 6 7 8 9 10 11 12 13
	Reg AF: 1/4" 5/16" 3/8"
	Deep mm: 6 7 8 9 10 11 12 13
1/4" Hex bits:	3.5, 4, 4.5, 5.5 (x2), 6.5, 8  PZ1 (x3), PZ2 (x6), PZ3
Length 25mm	PH1 (x3), PH2 (x6), PH3  2, 3, 4, 5, 6, 8 mm
	TX6, TX7, TX8, TX9, TX10, TX15, TX20(x3), TX25(x3), TX27, TX30, TX40
	TPX10, TPX15, TPX20 (x2), TPX25 (x2), TPX27, TPX30, TPX40
	ROB1, 2, 3  PH2G

Item ID: **TEA1487**

NEW



FOAM SERIES



3 Pieces 1/4" 3/8" 1/2"

**1/4", 3/8" & 1/2" RATCHET FLEX HEAD SET FOAM1 3 PIECES**

- Fine tooth stubby flex head ratchet
- Shorter handle for easier use in confined spaces
- Flexible ratchet head with locking mechanism for use at different angles
- 72 teeth giving 5 degree increments between clicks
- Twist reverse for quickly and easily changing between tightening and loosening
- Slim design together with a bi-material grip for extra comfort
- Tools are hold in place using three colour pre-cut high-density EVA foam clearly showing where each tool belongs
- Organised in a foam inlay module size 1 (FOAM1)

1/4" Drive 72 teeth flex head ratchet,  
3/8" Drive 72 teeth flex head ratchet,  
1/2" Drive 72 teeth flex head ratchet

Item ID: **TEA7203**



FOAM SERIES



36 Pieces 3/8" mm

**3/8" SOCKET SET 6 PT FOAM2 36 PIECES**

- 3/8" drive regular length sockets
- A range of 3/8" drive bits sockets covering hex and TX sizes
- Tools are held in place using three colour pre-cut high-density EVA foam clearly showing where each tool belongs
- Designed and manufactured to DIN and ISO standards
- Organised in a foam inlay module size 2 (FOAM2)

72 Teeth ratchet, Universal Joint, 3" Wobble extension bar,

1/2" F x 3/8" M T-bar adaptor, 10" Spinner handle

Regular 6 point sockets:

mm:	8	9	10	11	12	13	14	15	16
	17	18	19	22					

3/8" Drive bit sockets:

TX:	10	15	20	25	27	30	40	45	50
	mm:	3	4	5	5.5	6	7	8	10

Item ID: **TED3836**



FOAM SERIES



89 Pieces 1/4" mm

**1/4" SOCKET SET 6 PT FOAM2 89 PIECES**

- 1/4" drive regular and deep sockets
- A comprehensive range of 1/4" hex drive 25mm bits
- Tools are held in place using three colour pre-cut high-density EVA foam clearly showing where each tool belongs
- Designed and manufactured to DIN and ISO standards
- Organised in a foam inlay module size 2 (FOAM2)

72 Teeth ratchet, Universal Joint, Spinner handle, 2" & 4" Extension bars

Coupler adaptor, 3/8" F x 1/4" M T-bar adaptor, 1/4" M x 1/4" Hex adaptor

6 point sockets:

Reg mm:	4	5	5.5	6	7	8	9
	10	11	12	13			

Deep mm:	4	5	5.5	6	7	8	9
	10	12	13				

1/4" drive bit sockets:

mm:	4	5.5	7				
TX:	10	15	20	25	27	30	40
PZ:	1	2	3				
PH:	0	1	2	3			

1/4" Hex bits: TX8, TX10, TX15, TX20, TX25, TX27, TX30

TPX10, TPX15, TPX20, TPX25, TPX27, TPX30, TPX40

PZ0, PZ1, PZ2, PZ3 PH0, PH1, PH2, PH3, PH4

3, 4, 5, 6, 8, 10 1/8, 9/64, 5/32, 3/16, 1/4, 5/16

3, 4, 5.5, 7 XZN: 5, 6

Item ID: **TED1489**

FOAM Series | Tool Trays



FOAM SERIES



27 Pieces 1/2" mm

1/2" SOCKET SET 12 PT FOAM2 27 PIECES

- 1/2" drive regular and deep sockets
- Tools are held in place using three colour pre-cut high-density EVA foam clearly showing where each tool belongs
- Designed and manufactured to DIN and ISO standards
- Organised in a foam inlay module size 2 (FOAM2)

72 Teeth ratchet, 2½" & 6" Extension bars						
Universal joint, 3/8" F x 1/2" M T-bar adaptor						
12 point sockets:						
Reg mm:	10	11	12	13	14	15
	16	17	18	19	22	24
Deep mm:	10	11	12	13	14	15
	16	17	18	19		

Item ID: TED1227

NEW

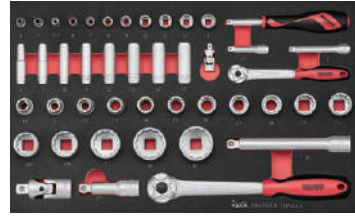

FOAM SERIES



44 Pieces 1/4" 1/2" mm

1/4" & 1/2" SOCKET SET FOAM3 44 PIECES

- Includes 72 teeth quick release, twist reverse ratchets
- A selection of extensions bars and accessories
- 12 points regular sockets and deep 6 points
- Tools are hold in place using three colour pre-cut high-density EVA foam clearly showing where each tool belongs
- Design to fit exactly in the TengTools service cases
- Designed and manufactured to DIN and ISO standards
- Organised in a foam inlay module size 3 (FOAM3)

1/4" Drive	72 Teeth ratchet, 2" & 3" extension bars, Universal joint, Spinner handle
1/2" Drive	72 Teeth ratchet, 3" & 6" Wobble extension bars, Universal joint
1/4" Drive 12 point sockets:	
Reg mm:	4 5 5.5 6 7 8
	9 10 11 12 13
Deep mm:	6 7 8 9 10 11 12 13
1/2" Drive 12 point sockets:	
Reg mm:	10 11 12 13 14 15 16 17 18
	19 21 22 24 27 30 32

Item ID: TEFSK44



FOAM SERIES

4x4

63 Pieces 1/2" mm

**1/2" SOCKET SET 12 PT FOAM4X4 63 PIECES**

- 1/2" drive regular and deep 12 point bi-hexagon sockets
- Tools are held in place using three colour pre-cut high-density EVA foam clearly showing where each tool belongs
- Designed to fit exactly in the larger TengTools tool box drawers
- Can be used as a set on it's own or as part of the TengTools Tool Control system
- Designed and manufactured to DIN and ISO standards
- Organised in a foam inlay module size 4X4 (FOAM4X4)

72 Teeth ratchet, 2½", 5", 6" & 20" Extension bars, 3", 6" & 10" Wobble extension bars

Universal joint, 1/2"F x 3/8"M adaptor, 1/2"F x 3/4"M adaptor

Coupler adaptors for 5/16", 10mm & 12mm bits, Flex head adaptor

12 point sockets:

Reg mm:	8	9	10	11	12	13	14	15	16
	17	18	19	20	21	22	24	25	26
	27	28	29	30	32	34			
Deep mm:	10	11	12	13	14	15	16	17	18
	19	20	21	22	24	27	30	32	36

Item ID: **TTESK63**



FOAM SERIES

x4

13 Pieces

**EXTENSION BARS SET FOAMX4 13 PIECES**

- Includes a selection of long and wobble extension bars
- TengTools T-HD handle included for a more comfortable grip
- Tools are held in place using three colour pre-cut high-density EVA foam clearly showing where each tool belong
- Designed and manufactured to DIN and ISO standards
- Organised in a foam inlay module size X4 (FOAMX4)

1/4" Drive 6" & 12" Extension bars, Universal joint

3/8" Drive 3" Wobble extension bar, 20" Extension bar, Universal joint, 3/8"F x 1/4"M T-bar adaptor

1/2" Drive 3" Wobble extension bar, 20" Extension bar, Universal joint

T-handle grip, 2mm & 2.5mm Mini Hex Screwdrivers

Item ID: **TEXEXT13**



FOAM SERIES

x4

3 Pieces

3/4"

**3/4" RATCHET & ACCESSORIES SET FOAMX4**

- Quick release and twist reverse action for easier use
- Sliding T-bar and 16" (400mm) extension also included
- Tools are held in place using three colour pre-cut high-density EVA foam clearly showing where each tool belong
- Designed and manufactured to DIN and ISO standards
- Organised in a foam inlay module size X4 (FOAMX4)

Quick release 72 teeth ratchet, 16" Extension bar

Sliding T-bar

Item ID: **TEX3403**

FOAM Series | Tool Trays



FOAM SERIES



10 Pieces 3/4" mm

3/4" SOCKET SET 6 PT FOAMX4 10 PIECES

- Chrome vanadium
- Satin finish for a better grip when handling the sockets
- 6 point single hexagon sockets for a better grip
- Tools are held in place using three colour pre-cut high-density EVA foam clearly showing where each tool belongs
- Designed and manufactured to DIN3120/3124
- Organised in a foam inlay module size X4 (FOAMX4)

Regular 6 point sockets:

mm:	22	24	27	30	32	36
	38	41	46	50		

Item ID: **TEX3410**



FOAM SERIES



32 Pieces 3/4" mm AF

3/4" SOCKET SET FOAM4X4 32 PIECES

- 3/4" drive regular sockets
- With safety locking system to avoid tools being dropped
- Tools are held in place using three colour pre-cut high-density EVA foam clearly showing where each tool belongs
- Can be used as a set on it's own or as part of the TengTools Tool Control system
- Designed and manufactured to DIN and ISO standards
- Organised in a foam inlay module size 4X4 (FOAM4X4)

Quick release 72 teeth ratchet, 16" Extension bar

Sliding T-bar, 19" Flex handle

Regular 6 point sockets:

mm:	19	21	22	24	27	30	32	33	34
	36	38	41	46	50				

Regular 12 point sockets:

AF:	7/8	15/16	1	1-1/16	1-1/8	1-3/16	1-1/4	1-5/16	1-3/8
	1-7/16	1-1/2	1-5/8	1-3/4	1-7/8				

Item ID: **TTESK32**



FOAM SERIES



57 Pieces 1/4" 3/8" mm

SPANNER & SOCKET SET FOAM3 57 PIECES

- Spanner and socket set
- Tools are held in place using three colour pre-cut high-density EVA foam clearly showing where each tool belongs
- Designed to fit exactly in the TengTools service cases
- Can be used as a set on it's own or as part of the TengTools Tool Control system
- Designed and manufactured to DIN and ISO standards
- Organised in a foam inlay module size 3 (FOAM3)

1/4" Drive 72 Teeth ratchet, 2" & 3" extension bars, 3/8"F x 1/4"M adaptor, 1/4"Hex x 1/4"M adaptor, Coupler adaptor, Universal joint

3/8" Drive 72 Teeth ratchet, 3" & 6" Extension bars, 1/2"F x 3/8"M adaptor, Coupler adaptor, Universal joint

1/4" Drive 6 point sockets:

Reg mm:	4	5	5.5	6	7
	8	10	11	12	13

Deep mm: 6 7 8 10 12 13

3/8" Drive 6 point sockets:

Reg mm:	8	9	10	11	12	13	14	15	16
	17	18	19	21	22				

Spark plug sockets mm: 16 21

Combination Spanners: 8, 9, 10, 11, 12, 13, 14, 15, 16, 17, 18, 19 mm

Item ID: **TEFSK57**

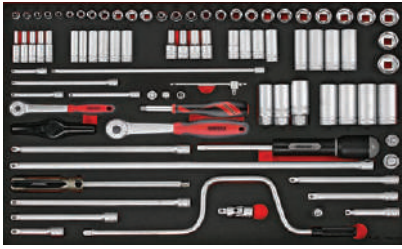

FOAM SERIES

4x4

86 Pieces 1/4" 3/8" mm

**1/4" & 3/8" SOCKET SET FOAM4X4 86 PIECES**

- Includes 72 teeth quick release, twist reverse ratchets
- Speed brace for quickly transporting nuts and bolts
- A selection of extension bars and accessories
- Tools are held in place using three colour pre-cut high-density EVA foam clearly showing where each tool belongs
- Can be used as a set on it's own or as part of the TengTools Tool Control system
- Designed and manufactured to DIN and ISO standards
- Organised in a foam inlay module size 4X4 (FOAM4X4)

1/4" Drive	72 Teeth ratchet, 6" Spinner handle, Universal joint, Coupler adaptor, 2", 3", 4", 6" & 12" Extension bars, 1/4"F x 3/8"M adaptor, Sliding T-bar, T-bar handle adaptor
3/8" Drive	72 Teeth ratchet, Speed brace, Spinner handle, Universal Joint, 3", 5", 6", 10" & 20" Extension bars, 3/8"F x 1/4"M adaptor, 3/8"F x 1/2"M adaptor, Coupler adaptor
1/4" Drive 6 point sockets:	
Reg mm:	4 4.5 5 5.5 6 7 8 9 10 11 12 13
Deep mm:	4 5 5.5 6 7 8 9 10 11 12 13
3/8" Drive 6 point sockets:	
Reg mm:	7 8 9 10 11 12 13 14 15 16 17 18 19 20 21 22
Deep mm:	7 8 9 10 11 12 13 14 15 16 17 18 19 20 21 22
Spark plug sockets mm:	16 18 21

Item ID: **TTESK86**

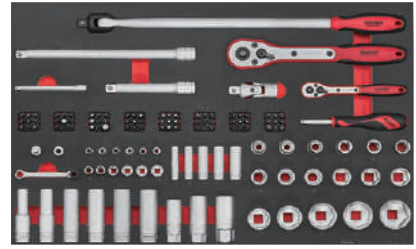

FOAM SERIES

4x4

126 Pieces 1/4" 1/2" mm

**1/4" & 1/2" SOCKET SET 6 PT FOAM4X4**

- Includes FRP 45 teeth quick release, flip reverse ratchets
- Includes a wide selection of 25mm screwdriver bits together with adaptors and the mini bits ratchet
- Tools are held in place using three colour pre-cut high-density EVA foam clearly showing where each tool belongs
- Can be used as a set on it's own or as part of the TengTools Tool Control system
- Designed and manufactured to DIN and ISO standards
- Organised in a foam inlay module size 4X4 (FOAM4X4)

1/4" Drive	Flip reverse ratchet, Mini bits ratchet, 4" Extension bar, Universal joint, 6" Spinner handle, Coupler adaptor, 1/4"M x 1/4"Hex adaptor
1/2" Drive	Flip reverse ratchet, 17" Flex handle, 5" & 10" Extension bars, Universal joint
1/4" Drive 6 point sockets:	
Reg mm:	4 4.5 5 5.5 6 7 8 9 10 11 12 13
Deep mm:	7 8 10 11 13
1/2" Drive 6 point sockets:	
Reg mm:	10 11 12 13 14 15 16 17 18 19 20 21 24 27 30 32 34
Deep mm:	10 13 16 17 18 19
Spark plug sockets mm:	16 18 21
1/4" Hex bits:	3.5, 4, 4.5, 5.5 (x2), 6.5 (x2), 8 mm
	TPX10, TPX15, TPX20 (x2), TPX25 (x2), TPX27, TPX30, TPX40
	TX6, TX7, TX8, TX9, TX10, TX15, TX20 (x3), TX25 (x3), TX27, TX30 (x2), TX40
	PH1 (x4), PH2 (x7), PH3 (x2)
	PZ1 (x4), PZ2 (x7), PZ3
	2, 3, 4, 5, 6, 8 1, 2, 3 PH2G (x3)

Item ID: **TTESK126**



FOAM Series | Tool Trays

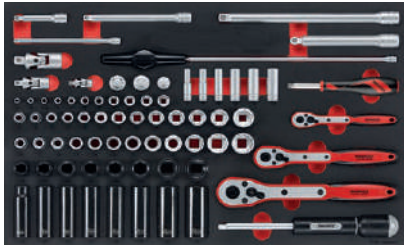

FOAM SERIES

4x4

- 77 Pieces
- 1/4"
- 3/8"
- 1/2"
- mm

1/4", 3/8" & 1/2" SOCKET SET FOAM4X4

- Includes FRP 45 teeth quick release, flip reverse ratchets
- A selection of extension bars and adaptors to suit different applications
- Tools are held in place using three colour pre-cut high-density EVA foam clearly showing where each tool belongs
- Can be used as a set on it's own or as part of the TengTools Tool Control system
- Designed and manufactured to DIN and ANSI standards
- Organised in a foam inlay module size 4X4 (FOAM4X4)

1/4" Drive	Flip reverse ratchet, 6" Spinner handle, 6" & 12" Extension bars, Universal joint, T-bar & T-bar handle adaptor
3/8" Drive	Flip reverse ratchet, 3" Wobble extension bar, 6" Extension bar, Universal joint, 3/8"F x 1/4"M adaptor, 3/8"F x 1/2"M adaptor, Rotating spinner handle
1/2" Drive	Flip reverse ratchet, 6" Wobble extension bar, 10" Extension bar, Universal joint, 1/2"F x 3/8"M adaptor
1/4" Drive 6 point sockets:	
Reg mm:	4 5 5.5 6 7 8 9 10 11 12 13
Deep mm:	6 7 8 10 12 13
3/8" Drive 6 point sockets:	
Reg mm:	8 9 10 11 12 13 14 15 16 17 18 19 22
1/2" Drive 12 point sockets:	
Reg mm:	10 11 12 13 14 15 16 17 18 19 22
1/2" Drive 6 point ANSI impact sockets:	
Reg mm:	13 15 16 17 18 19 22 24
Deep mm:	13 15 16 17 18 19 22 24

Item ID: **TTESK77**

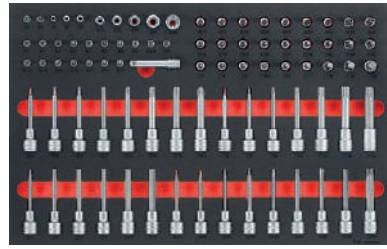

FOAM SERIES

4x4

- 85 Pieces
- 1/4"
- 3/8"
- 1/2"
- mm

1/4", 3/8" & 1/2" SOCKET SET FOAM4X4

- An extensive range of short and long reach screwdriver, hex and TX bits
- Tools are held in place using three colour pre-cut high-density EVA foam clearly showing where each tool belongs
- Designed to fit exactly in the larger TengTools tool box drawers
- Can be used as a set on it's own or as part of the TengTools Tool Control system
- Designed and manufactured to DIN and ISO standards
- Organised in a foam inlay module size 4X4 (FOAM4X4)

3/8" Drive	3" Extension bar
1/4" Drive bit sockets:	
	mm: 4 5.5 7
	PZ: 1 2 3
	PH: 0 1 2 3
	TX: 10 15 20 25 27 30 40
	TX-E: E4 E5 E6 E7 E8
3/8" Drive bit sockets:	
	TX: 10 15 20 25 27 30 40 45 50
	TPX: 10 15 20 25 27 30 40 45 50
	TX-E: E10 E12 E14 E16 E18
	Hex: 3 4 5 5.5 6 7 8 10 12
1/2" Drive bit sockets:	
	TX: 20 25 27 30 40 45 50 55 60
	Long Hex: 5 6 7 8 10 12
	Ribe: 4 5 6 8 10 11 12 13
	XZN: M5 M6 M8 M10 M12 M14 M16

Item ID: **TTESK85**



FOAM SERIES



16 Pieces 1/2" AF

**1/2" IMPACT SOCKET SET DIN AF FOAM2**

- DIN standard design for use with a retaining pin and ring.
- Chrome molybdenum for use with power tools.
- Black phosphate finish for easy identification as an impact socket.
- Ring and pin fixing hole on the female end to secure the socket.
- Retaining ring and pin included in the set.
- Tools are held in place using three colour pre-cut high-density EVA foam clearly showing where each tool belongs
- Designed and manufactured to ASME B107.110
- Organised in a foam inlay module size 1 (FOAM1)

Retaining rings & pins: O92194, O92244, P92320, P92325 x1

1/2" Drive Impact 6 point sockets:

Reg AF:	3/8"	7/16"	1/2"	9/16"	5/8"	3/4"	13/16"	7/8"	1"
	1-1/16"	1-1/8"	1-1/4"						

Item ID: **TEA9216AF**



FOAM SERIES



14 Pieces 1/2" AF

**1/2" IMPACT SOCKET SET DEEP DIN AF FOAM2**

- DIN standard design for use with a retaining pin and ring
- Chrome molybdenum for use with power tools
- Black phosphate finish for easy identification as an impact socket
- Ring and pin fixing hole on the female end to secure the socket
- Retaining ring and pin included in the set
- Tools are held in place using three colour pre-cut high-density EVA foam clearly showing where each tool belongs
- Designed and manufactured to ASME B107.110
- Organised in a foam inlay module size 1 (FOAM1)

Retaining rings & pins: O92194, O92244, P92320, P92325 x1

1/2" Drive Impact 6 point sockets:

Deep AF:	7/16"	1/2"	9/16"	5/8"	11/16"
	3/4"	13/16"	7/8"	15/16"	1"

Item ID: **TEA9214LAF**



FOAM SERIES



21 Pieces 1/2" mm

**1/2" IMPACT SOCKET SET ANSI FOAM2**

- ANSI standard design for use with power tools with a ball bearing socket retainer
- Selection of extension bars and adaptors
- Tools are held in place using three colour pre-cut high-density EVA foam clearly showing where each tool belongs
- Organised in a foam inlay module size 2 (FOAM2)

3" & 10" Extension bars, Universal joint, 3/8"F x 1/2"M & 1/2"F x 3/4"M Impact adaptors

1/2" Drive Impact 6 point sockets:

Reg mm:	13	15	16	17	18	19	22	24
Deep mm:	13	15	16	17	18	19	22	24

Item ID: **TED9121**

# FOAM Series | Tool Trays









FOAM SERIES

4x4

73 Pieces 3/8" 1/2" mm

## 3/8" & 1/2" IMPACT SOCKET SET FOAM4X4

- Extension bars and adaptors included
- DIN & ANSI standard 1/2" drive sockets included
- Chrome molybdenum for use with power tools
- Designed to fit exactly in the larger TengTools tool box drawers
- Can be used as a set on it's own or as part of the TengTools Tool Control system
- Retaining rings and pins included
- Organised in a foam inlay module size 4X4 (FOAM4X4)

3/8" Drive	3" Extension bar, 3/8" F x 1/2" M & 3/8" F x 1/4" F Impact adaptors, Coupler adaptor for 1/4" hex bits
1/2" Drive	3", 5" & 10" Extension bars, Universal joint, 1/2" F x 3/4" M & 1/2" F x 3/8" M Impact adaptors, Coupler adaptor for 5/16" hex bits
Retaining rings & pins: O92194, O92244, P92320, P92325 x1	
3/8" Drive Impact 6 point sockets: 	
 Reg mm:	8 10 11 12 13 14 15 16 17 19
 Deep mm:	8 10 11 12 13 14 16 17 19
1/2" Drive Impact 6 point sockets: 	
 Reg mm:	8 10 11 12 13 14 15 16 17 18 19 20 21 22 23 24 25 26 27 28 29 30 32
 Deep mm:	10 11 12 13 14 15 16 17 18 19 21 22 24 27 28 29 30 32 35 36

Item ID: TTEISK73

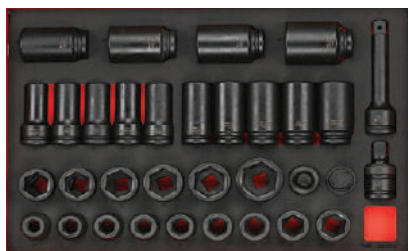



FOAM SERIES

4x4

33 Pieces 3/4" mm

## 3/4" IMPACT SOCKET SET DIN FOAM4X4

- Extension bars and adaptors included
- DIN standard design for use with a retaining pin and ring
- Chrome molybdenum for use with power tools
- Designed to fit exactly in the larger TengTools tool box drawers
- Can be used as a set on it's own or as part of the TengTools Tool Control system
- Retaining rings and pins included
- Organised in a foam inlay module size 4X4 (FOAM4X4)

7" Extension bar, Universal joint, 3/4" F x 1/2" M & 3/4" F x 1" M Impact adaptors	
Retaining rings & pins: O95036, P90435 x2	
3/4" Drive Impact 6 point sockets: 	
 Reg mm:	19 21 22 23 24 27 28 30 32 33 34 36 38 41 46
 Deep mm:	19 21 22 23 24 27 30 32 33 34 36 38 41 46

Item ID: TTEISK33

TORQUE TOOLS



FOAM SERIES



38 Pieces

1/4"

TORQUE SCREWDRIVER SET FOAM1

- 1-5 Nm torque screwdriver with accessories
- Accurate to +/- 6% and conforms to ISO6789 for assured accuracy
- Tools are held in place using three colour pre-cut high-density EVA foam clearly showing where each tool belongs
- Organised in a foam inlay module size 1 (FOAM1)

1-5Nm Torque screwdriver, 1/4" M x 1/4" Hex adaptor

1/4" Hex bits:	3, 4, 5, 5.5, 6.5	PH0, PH1, PH2, PH3	PH2G (X2)
Length 25mm	2, 3, 4, 5, 6	PZ0, PZ1, PZ2, PZ3	ROB1, 2, 3
	TX8, TX9, TX10, TX15, TX20, TX25, TX27, TX30, TX40		
	TPX10, TPX15, TPX20, TPX30, TPX40		

Item ID: TEASD38

NEW



FOAM SERIES



2 Pieces

1/4"

1/4" TORQUE SET FOAMX2 2 PIECES

- Includes a 1/4" drive torque wrench giving a range of 5-25 Nm
- Includes a 1-5 Nm 1/4" drive torque screwdriver
- Each torque tool has its own individual certification number
- Conforms to ISO6789 for assured accuracy
- Tools are hold in place using three colour pre-cut high-density EVA foam clearly showing where each tool belongs
- Organised in a foam inlay module size X2 (FOAMX2)

1/4" Drive

1-5 Nm Torque screwdriver, 5-25 Nm Torque Wrench

Item ID: TEZSD02



FOAM SERIES



95 Pieces

1/4"

TORQUE SCREWDRIVER SET FOAM2

- 1-5 Nm torque screwdriver with accessories
- Accurate to +/- 6% and conforms to ISO6789 for assured accuracy
- Ratcheting bits driver set included
- Tools are held in place using three colour pre-cut high-density EVA foam clearly showing where each tool belongs
- Organised in a foam inlay module size 2 (FOAM2)

1/4" Drive 1-5 Nm Torque screwdriver, Quick release chuck, Sliding T-bar, 6" Flexible extension, Ratcheting bits driver with assorted bits, 1/4" M x 1/4" hex adaptor

1/2" Drive 1/2" M x 5/16" Hex adaptor, Reversible impact driver, 5/16" Hex bit adaptor

5/16" Hex bits: Length 36mm	TX30, TX40, TX45, TX50, TX55	6, 8, 10, 12
1/4" Hex bits: Length 25mm	PH1, PH2, PH3, PH4	4, 5, 6, 8
	PZ1 (x3), PZ2 (x6), PZ3	2, 3, 4, 5, 6, 8
	PH1 (x3), PH2 (x6), PH3	PH2G (x3)
	TX6, TX7, TX8, TX9, TX10, TX15, TX20 (x3), TX25 (x3), TX27, TX30, TX40	
	TPX10, TPX15, TPX20 (x2), TPX25 (x2), TPX27, TPX30, TPX40	

Item ID: TEDSD14

FOAM Series | Tool Trays



FOAM SERIES

x4

2 Pieces 3/8" 1/2"

3/8" & 1/2" TORQUE WRENCH SET FOAMX4

- Equipped with an in-built angular gauge for easier after tightening
- Click type mechanism to signal when the required torque is reached
- Additional ft/lb reference scale
- Marked to show the correct place where pressure should be applied
- Twist locking facility to ensure the set torque is maintained
- Reversible 24 teeth ratchet (DIN3122) giving 15° increments
- Designed to torque right hand (clockwise) fasteners
- Accurate to +/- 4% conforms to ISO6789 for assured accuracy
- Individually tested and certified at the time of manufacture
- Tools are held in place using three colour pre-cut high-density EVA foam
- Organised in a foam inlay module size X4 (FOAMX4)

Torque Wrenches

3/8" Drive	20-110Nm (15-81 ft/lb)
1/2" Drive	40-210Nm (30-150 ft/lb)

Item ID: **TEX1238**



FOAM SERIES

x4

2 Pieces 1/2" 3/4"

1/2" TORQUE MULTIPLIER SET FOAMX4

- Includes a 1/2" drive torque wrench giving a range of 40 to 210Nm
- The torque multiplier can then be used to multiply the torque at a ratio of 1:3 increasing the potential torque to 630Nm
- For use with 3/4" drive sockets
- Tools are held in place using three colour pre-cut high-density EVA foam
- Organised in a foam inlay module size X4 (FOAMX4)

1/2" Drive Torque wrench (40-210Nm, 30-150 ft/lb)

1/2" F:3/4" M Torque multiplier (1:3 ratio) and maximum torque capacity 1,500Nm

Item ID: **TEXMP12**

SPANNERS & WRENCHES



FOAM SERIES

2

12 Pieces mm

COMBINATION SPANNER SET ANTI SLIP FOAM2

- Off set at 15° for easier use on flat surfaces
- TengTools hip grip design on the ring and open end for contact with the flat side of the fastening
- TengTools anti slip design on the open end to give a much better grip
- Tools are held in place using three colour pre-cut high-density EVA foam
- Organised in a foam inlay module size 2 (FOAM2)

Combination Spanners:

8, 9, 10, 11, 12, 13, 14, 15, 16, 17, 18, 19 mm



Item ID: **TED8012**



FOAM SERIES

2

15 Pieces mm

COMBINATION SPANNER SET FOAM2 15 PIECES

- Off set at 15° for easier use on flat surfaces
- TengTools hip grip design for contact with the flat side of the fastening
- Tools are held in place using three colour pre-cut high-density EVA foam
- Designed and manufactured to DIN3113A
- Organised in a foam inlay module size 2 (FOAM2)

Combination Spanners:

5.5, 6, 7, 8, 9, 10, 11, 12, 13, 14, 15, 16, 17, 18, 19 mm

Item ID: **TED6515**



FOAM SERIES

X4

7 Pieces mm

**COMBINATION SPANNER SET FOAMX4 7 PIECES**

- Chrome vanadium, satin finish
- Off set at 15° for easier use on flat surfaces
- TengTools hip grip design for contact with the flat side of the fastening
- Tools are held in place using three colour pre-cut high-density EVA foam
- Designed and manufactured to DIN3113A
- Organised in a foam inlay module size X4 (FOAMX4)

Combination Spanners:

20, 21, 22, 24, 27, 30, 32 mm

Item ID: **TEX2032**

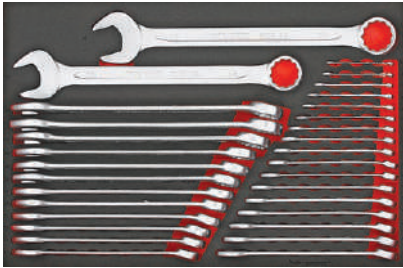

FOAM SERIES

4X4

31 Pieces mm

**COMBINATION SPANNER SET FOAM4X4 AF**

- Off set at 15° for easier use on flat surfaces
- TengTools hip grip design for contact with the flat side of the fastening
- Chrome vanadium satin finish
- Tools are held in place using three colour pre-cut high-density EVA foam
- Designed to fit exactly in the larger TengTools tool box drawers
- Designed and manufactured to DIN3113A
- Organised in a foam inlay module size 4X4 (FOAM4X4)

Combination Spanners:

5.5, 6, 7, 8, 9, 10, 11, 12, 13, 14, 15, 16, 17, 18, 19, 20, 21, 22, 23, 24, 25, 26, 27, 28, 29, 30, 32, 33, 34, 36, 38 mm

Item ID: **TTESP31**



FOAM SERIES

4X4

62 Pieces 1/4" 3/8" 1/2" AF

**SOCKET & SPANNER SET AF FOAM4X4**

- Combination spanners and a range of socketry
- Tools are held in place using three colour pre-cut high-density EVA foam
- TengTools hip grip design for contact with the flat side of the fastening
- Chrome vanadium satin finish
- Designed to fit exactly in the larger TengTools tool box drawers
- Designed and manufactured to DIN and ISO standards
- Organised in a foam inlay module size 4X4 (FOAM4X4)

1/4" Drive 6 point sockets:

- Reg AF: 3/16" 7/32" 1/4" 9/32" 5/16" 11/32" 3/8" 7/16" 1/2"
- Deep AF: 3/16" 7/32" 1/4" 9/32" 5/16" 11/32" 3/8" 7/16" 1/2"

3/8" Drive 6 point sockets:

- Reg AF: 3/8" 7/16" 1/2" 9/16" 5/8" 11/16" 3/4"
- Deep AF: 3/8" 7/16" 1/2" 9/16" 5/8" 11/16" 3/4"

1/2" Drive 12 point sockets:

- Reg AF: 3/8" 7/16" 1/2" 9/16" 5/8" 11/16" 3/4" 13/16" 7/8" 15/16" 1" 1-1/8" 1-3/16" 1-1/4"

Combination Spanners:

5/16", 3/8", 7/16", 1/2", 9/16", 5/8", 11/16", 3/4", 13/16", 7/8", 15/16", 1", 1-1/16", 1-1/8", 1-1/4"

Item ID: **TTEAF62**

FOAM Series | Tool Trays



FOAM SERIES

4x4

32 Pieces mm

SPANNER & FILE SET FOAM4X4 32 PIECES

- 72 teeth ratchet spanners, turn over to change direction
- Chrome vanadium satin finish
- The five most used 10" hand files included
- Tools are held in place using three colour pre-cut high-density EVA foam
- Designed to fit exactly in the larger TengTools tool box drawers
- Organised in a foam inlay module size 4X4 (FOAM4X4)

Combination Spanners:

8, 9, 10, 11, 12, 13, 14, 15, 16, 17, 18, 19, 20, 21, 22, 24, 27, 30, 32 mm

Ratchet Spanners:

8, 10, 11, 12, 13, 14, 17, 19 mm

10" Engineers Files:

Flat, Round, Half Round, Three Square & Hand Type Flat

Item ID: TTEX32



FOAM SERIES

2

12 Pieces mm

RATCHETING COMBI SPANNER SET R FOAM2

- 72 teeth ratchet spanners giving a 5° increment between clicks
- Reversible ratchet mechanism with hip grip & flip reverse lever
- Tools are held in place using three colour pre-cut high-density EVA foam
- Designed and manufactured to DIN ISO 1711-1 and DIN 3113A
- Organised in a foam inlay module size 2 (FOAM2)

Ratchet Spanners with flip reverse switch:

8, 9, 10, 11, 12, 13, 14, 15, 16, 17, 18, 19 mm

Item ID: TED6512R



FOAM SERIES

2

12 Pieces mm

RATCHETING COMBI SPANNER SET RS FOAM2

- 72 teeth ratchet spanners giving a 5° increment between clicks
- Hip grip on the ring end, turn spanner over to change direction
- Tools are held in place using three colour pre-cut high-density EVA foam
- Designed and manufactured to DIN ISO 1711-1 and DIN 3113A
- Organised in a foam inlay module size 2 (FOAM2)

Ratchet Spanners:

8, 9, 10, 11, 12, 13, 14, 15, 16, 17, 18, 19 mm

Item ID: TED6512RS

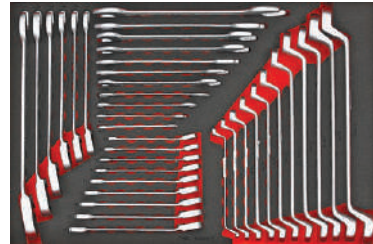

FOAM SERIES

4x4

37 Pieces mm

SPANNER SET FOAM4X4 37 PIECES

- 72 teeth ratcheting combination spanners with flip reverse lever
- Double open ended and double ring spanners
- Chrome vanadium satin finish
- Tools are held in place using three colour pre-cut high-density EVA foam
- Designed to fit exactly in the larger TengTools tool box drawers
- Designed and manufactured to DIN and ISO standards
- Organised in a foam inlay module size 4X4 (FOAM4X4)

Ratchet Spanners:

8, 9, 10, 11, 12, 13, 14, 15, 16, 17, 18, 19, 22, 24, 27 mm

Double Open Ended Spanners:

6x7, 8x9, 10x11, 12x13, 14x15, 16x17, 18x19, 20x22, 21x23, 24x27, 30x32 mm

Double Ring Spanners:

6x7, 8x9, 10x11, 12x13, 14x15, 16x17, 18x19, 20x22, 21x23, 24x27, 30x32 mm

Item ID: TTESP37



FOAM SERIES



8 Pieces mm

**DOUBLE RING SPANNER SET FOAMX4 8 PIECES**

- Different size at each end to give 16 sizes in total
- Double curved heads offset at 75° for easier use on flat surfaces
- Chrome vanadium satin finish
- TengTools hip grip design for contact with the flat side of the fastening
- Tools are held in place using three colour pre-cut high-density EVA foam
- Designed and manufactured to DIN838
- Organised in a foam inlay module size X4 (FOAMX4)

Double Ring Spanners:

6x7, 8x9, 10x11, 12x13, 14x15, 16x17, 18x19, 20x22 mm

Item ID: **TEX6308**



FOAM SERIES



6 Pieces mm

**LONG DOUBLE RING SPANNER SET FOAMX4**

- Different size at each end to give 12 sizes in total
- Extra long, flat design for extra torque
- Chrome vanadium satin finish
- TengTools hip grip design for contact with the flat side of the fastening
- Tools are held in place using three colour pre-cut high-density EVA foam
- Designed and manufactured to DIN837
- Organised in a foam inlay module size X4 (FOAMX4)

Extra long Double Ring Spanners:

8x10, 11x13, 12x14, 16x18, 17x19, 22x24 mm

Item ID: **TEXFLS06**



FOAM SERIES



7 Pieces mm

**DOUBLE FLEX WRENCH SET FOAM2 7 PIECES**

- Swivel end wrenches for fast pre-tightening and loosening
- Angle at 90° for added torque when applying the final tightening
- Extra torque for loosening stubborn fastenings
- Tools are held in place using three colour pre-cut high-density EVA foam
- Designed and manufactured to DIN standard
- Organised in a foam inlay module size 2 (FOAM2)

Double Flex Wrenches

8x9, 10x11, 12x13, 14x15, 16x17, 18x19 mm

B-flex Wrench:

1/4" Male x 1/4" Hex Female

Item ID: **TEDDF7**



FOAM SERIES



4 Pieces TPR GRIP

**ADJUSTABLE WRENCH SET FOAM2 4 PIECES**

- Includes regular style 6, 8 and 10" adjustable wrenches
- Also includes an 8" wide jaw adjustable wrench for added versatility
- Tools are held in place using three colour pre-cut high-density EVA foam
- Designed and manufactured to DIN3117 and ISO6787
- Organised in a foam inlay module size 2 (FOAM2)

Adjustable Wrenches

6" (150 mm) Capacity: 24 mm

8" (200 mm) Capacity: 28 mm

10" (250 mm) Capacity: 33 mm

8" (200 mm) Wide Jaw Capacity: 38 mm

Item ID: **TEDADJ4**



FOAM Series | Tool Trays

SCREWDRIVERS

NEW



FOAM SERIES



4 Pieces

SCREWDRIVER SET FLAT FOAM1 4 PIECES

- TT-MV PLUS steel alloy for greater strength and material flexibility
- Ergonomically design bi-material handle for easy use with higher torque
- Hanging hole in the handle for use as a T handle or with a fall protection wire
- The handle is moulded around the blade to give a higher torque capacity
- Tools are hold in place using three colour pre-cut high-density EVA foam clearly showing where each tool belongs. Design and manufactured to DIN5264
- Organised in a foam inlay module size X2 (FOAMX2)

Screwdrivers:

mm:	3.0 x 75	4.0 x 100	5.5 x 75	6.5 x 100
-----	----------	-----------	----------	-----------

Item ID: TEAMD04N

NEW



FOAM SERIES



4 Pieces

SCREWDRIVER SET PH/PZ FOAM1 4 PIECES

- TT-MV PLUS steel alloy for greater strength and material flexibility
- Ergonomically design bi-material handle for easy use with higher torque
- Hanging hole in the handle for use as a T handle or with a fall protection wire
- The handle is moulded around the blade to give a higher torque capacity
- Tools are hold in place using three colour pre-cut high-density EVA foam clearly showing where each tool belongs
- Design and manufactured to DIN ISO 8764
- Organised in a foam inlay module size X2 (FOAMX2)

Screwdrivers:

mm:	PH0 x 75	PH1 x 75	PH2 x 100
mm:	PZ1 x 75		

Item ID: TEAMD04N1

NEW



FOAM



4 Pieces

SCREWDRIVER SET TX FOAM1 4 PIECES

- TT-MV PLUS steel alloy for greater strength and material flexibility
- Ergonomically design bi-material handle for easy use with higher torque
- Hanging hole in the handle for use as a T handle or with a fall protection wire
- The handle is moulded around the blade to give a higher torque capacity
- Tools are hold in place using three colour pre-cut high-density EVA foam clearly showing where each tool belongs
- Organised in a foam inlay module size X2 (FOAMX2)

Screwdrivers:

mm:	TX10 x 100	TX15 x 100	TX20 x 100	TX25 x 100
-----	------------	------------	------------	------------

Item ID: TEAMD04TXN

NEW



FOAM SERIES



6 Pieces

STUBBY SCREWDRIVER SET FOAMX2 6 PIECES

- Collection of all stubby handle drivers for use in confined spaces
- TT-MV PLUS steel alloy for greater strength and material flexibility
- Ergonomically design bi-material handle for easy use with higher torque
- Hanging hole in the handle for use as a T handle or with a fall protection wire
- The handle is moulded around the blade to give a higher torque capacity
- Tools are hold in place using three colour pre-cut high-density EVA foam clearly showing where each tool belongs
- Organised in a foam inlay module size X2 (FOAMX2)

1/4" Stubby bits driver

Screwdrivers:

mm:	6.5 x 38
mm:	PH1 x 38 PH2 x 38
mm:	PZ1 x 38 PZ2 x 38

Item ID: TEZMD06



**FOAM SERIES**



**SCREWDRIVER SET MIXED FOAM2 11 PIECES**

- TT-MV PLUS steel alloy for greater strength and material flexibility
- Ergonomically designed bi-material handle for easy use with higher torque
- Hanging hole in the handle for use as a T handle or with a fall protection wire
- The handle is moulded around the blade to give a higher torque capacity
- Tools are held in place using three colour pre-cut high-density EVA foam
- Organised in a foam inlay module size 2 (FOAM2)

Screwdrivers:

-	mm:	3.5 x 100	5.5 x 75	6.5 x 38	5.5 x 125
		6.5 x 100			
+	mm:	PH0 x 75	PH1 x 75	PH2 x 38	PH2 x 100
+	mm:	PZ1 x 75	PZ2 x 100		

Item ID: **TED911N**



**FOAM SERIES**



**SCREWDRIVER SET FLAT & PH FOAMX4 5 PIECES**

- TT-MV PLUS steel alloy for greater strength and material flexibility
- Ergonomically designed bi-material handle for easy use with higher torque
- Hanging hole in the handle for use as a T handle or with a fall protection wire
- The handle is moulded around the blade to give a higher torque capacity
- Tools are held in place using three colour pre-cut high-density EVA foam
- Organised in a foam inlay module size X4 (FOAMX4)

Screwdrivers:

-	mm:	5.5 x 150	6.5 x 150	8 x 150	10 x 200
+	mm:	PH3 x 150			

Item ID: **TEX915N**



**FOAM SERIES**



**SCREWDRIVER SET TX FOAM2 9 PIECES**

- TT-MV PLUS steel alloy for greater strength and material flexibility
- Ergonomically designed bi-material handle for easy use with higher torque
- Hanging hole in the handle for use as a T handle or with a fall protection wire
- The handle is moulded around the blade to give a higher torque capacity
- Tools are held in place using three colour pre-cut high-density EVA foam
- Organised in a foam inlay module size 2 (FOAM2)

Screwdrivers:

*	mm:	TX6 x 75	TX8 x 75	TX9 x 75
		TX10 x 100	TX15 x 100	TX20 x 100
		TX25 x 100	TX27 x 100	TX30 x 100

Item ID: **TED909TXN**

FOAM Series | Tool Trays



FOAM SERIES  
4x4

122 Pieces

SCREWDRIVER SET MIXED FOAM4X4 122 PIECES

- TT-MV PLUS steel alloy for greater strength and material flexibility
- Ergonomically designed bi-material handle for easy use with higher torque
- Hanging hole in the handle for use as a T handle or with a fall protection wire
- The handle is moulded around the blade to give a higher torque capacity
- Tools are held in place using three colour pre-cut high-density EVA foam
- Designed to fit exactly in the larger TengTools tool box drawers
- Can be used as a set on it's own or as part of the TengTools Tool Control system
- Organised in a foam inlay module size 4X4 (FOAM4X4)

Screwdrivers:

mm:	2.5 x 75	3.5 x 75	3 x 100	4 x 100
	5.5 x 75	5.5 x 150	6.5 x 38	6.5 x 100
	6.5 x 150	8 x 150	10 x 200	

mm:	PH0 x 75	PH1 x 38	PH1 x 75	PH2 x 38
	PH2 x 100	PH3 x 150	PH4 x 200	

mm:	PZ0 x 75	PZ1 x 38	PZ1 x 100	PZ2 x 38
	PZ2 x 100	PZ2 x 150	PZ3 x 150	

1/4" Hex bits: Length 25mm

0.6x3.5, 0.6x4.5, 0.8x4(x2), 0.8x5.5, 1.0x5.5(x2), 1.2x6.5, 1.6x8

TPX10, TPX15, TPX20 (x2), TPX25 (x2), TPX27, TPX30, TPX40

TX6, TX7, TX8, TX9, TX10, TX15, TX20 (x3), TX25 (x3), TX27, TX30, TX40

PH1 (x3), PH2 (x3), PH3 (x3)

PZ1 (x3), PZ2 (x3), PZ3 (x3)

2, 3, 4, 5, 6, 8 1, 2, 3 PH2G (x3)

1/4" Hex bits: Length 50mm

0.6x3.5, 0.8x4, 0.8x5.5, 1x5.5, 1.2x6.5

TX8, TX10 (x2), TX15, TX20 (x2), TX25 (x2), TX27, TX30

PH1, PH2 (x2), PH3

PZ1, PZ2 (x2), PZ3 4, 5, 6, 8

6 in 1 Ratchetting Bits Driver Set

Bit Holder For 25 mm Bits

Item ID: TTEMD122N



FOAM SERIES  
4x4

98 Pieces

SCREWDRIVER SET MIXED FOAM4X4 98 PIECES

- TT-MV PLUS steel alloy for greater strength and material flexibility
- Ergonomically designed bi-material handle for easy use with higher torque
- Hanging hole in the handle for use as a T handle or with a fall protection wire
- The handle is moulded around the blade to give a higher torque capacity
- Mini screwdrivers feature a rotating end piece for easier use
- Tools are held in place using three colour pre-cut high-density EVA foam
- Organised in a foam inlay module size 4X4 (FOAM4X4)

Screwdrivers:

mm:	2.5 x 75	4 x 100	5.5 x 125
mm:	PH0 x 60	PH1 x 80	PH2 x 100
	PZ2 x 100		
mm:	TX8 x 75	TX9 x 75	
mm:	TPX10 x 100	TPX15 x 100	TPX20 x 200
	TPX25 x 100	TPX30 x 100	

Mini Screwdrivers:

mm:	2 x 40	2.5 x 40	3 x 40
mm:	PH00 x 40	PH0 x 40	PH1 x 40
mm:	TX6 x 40	TX7 x 40	TX8 x 40
	TX9 x 40	TX10 x 40	TX15 x 40

Power Through Screwdrivers:

mm:	6.5 x 100	8 x 150	10 x 200
mm:	PH2 x 100	PH3 x 150	

1/4" Hex bits: Length 25mm

0.6x3.5, 0.6x4.5, 0.8x4(x2), 0.8x5.5, 1x5.5(x2), 1.2x6.5, 1.6x8

TPX10, TPX15, TPX20 (x2), TPX25 (x2), TPX27, TPX30, TPX40

TX6, TX7, TX8, TX10, TX15, TX20 (x3), TX25 (x3), TX27, TX30, TX40

PH1 (x3), PH2 (x3), PH3 (x3)

PZ1 (x3), PZ2 (x3), PZ3 (x4)

2, 3, 4, 5, 6, 8 1, 2, 3 PH2G (x3)

6 in 1 Ratchetting Bits Driver Set, Magnetic Charger For Magnetising / Demagnetising Screwdriver Tips, 1/4" M: 1/4" Hex Adaptor, Coupler Adaptor

Item ID: TTEMD98N



FOAM SERIES

4x4



**SCREWDRIVER & SPANNER SET FOAM4X4**

- Selection of screwdrivers with ergonomically designed handles
- Chrome vanadium combination spanners
- Hex key set also included
- Tools are held in place using three colour pre-cut high-density EVA foam
- Organised in a foam inlay module size 4X4 (FOAM4X4)

Combination Spanners:

8, 10, 11, 12, 13, 14, 15, 16, 17, 18, 19 mm

Hex Key Set:

1.5, 2.0, 2.5, 3.0, 4.0, 5.0, 6.0, 8.0, 10.0 mm

Screwdrivers:

mm: 2.5 x 75 3.5 x 100 4.0 x 100 5.5 x 150

mm: PH1 x 75 PH2 x 100

mm: TX8 x 75 TX9 x 75

mm: TPX10 x 100 TPX15 x 100 TPX20 x 100 TPX25 x 100 TPX30 x 100

Item ID: **TTEMD33**



FOAM SERIES

3



**SCREWDRIVER & HEX/TX KEY SET 1 FOAM3**

- Selection of screwdrivers with other general tools
- Metric measuring tape
- Tools are held in place using three colour pre-cut high-density EVA foam
- Designed to fit exactly in the TengTools service cases
- Organised in a foam inlay module size 3 (FOAM3)

Ball Point Hex Keys:

mm: 1.5, 2.0, 2.5, 3.0, 4.0, 5.0, 6.0, 7.0, 10.0

TX Keys:

TX: 8, 9, 10, 15, 20, 25, 27, 30, 40

25 mm Bits:

mm 3.5, 5.5, 8.0

PH1, PH2, PH3

PZ1, PZ2, PZ3

10, 15, 20, 25, 30, 40

20, 25, 30

mm 2, 3, 4, 5, 6, 8

1, 2, 3

7 mm Hose Clip Drivers

100 mm Quick Chuck Bits Driver

5 m Measuring Tape - Metric Only

Item ID: **TEFMD54**

FOAM Series | Tool Trays



FOAM SERIES

3
---

54 Pieces

**SCREWDRIVER & HEX/TX KEY SET 2 FOAM3**

- Selection of screwdrivers with other general tools
- Metric/inch measuring tape
- Tools are held in place using three colour pre-cut high-density EVA foam
- Designed to fit exactly in the TengTools service cases
- Organised in a foam inlay module size 3 (FOAM3)

<b>Ball Point Hex Keys:</b>	<b>Screwdrivers:</b>
mm: 1.5, 2.0, 2.5, 3.0, 4.0, 5.0, 6.0, 7.0, 10.0	mm: 6.5 x 100
<b>TX Keys:</b>	mm: 4 x 101
TX: 8, 9, 10, 15, 20, 25, 27, 30, 40	mm: PH2 x 100
<b>25 mm Bits:</b>	mm: PH1 x 81
mm 3.5, 5.5, 8.0	mm: PZ2 x 100
PH1, PH2, PH3	mm: PZ1 x 81
PZ1, PZ2, PZ3	
10, 15, 20, 25, 30, 40	
20, 25, 30	
mm 2, 3, 4, 5, 6, 8	
1, 2, 3	
<b>7 mm Hose Clip Drivers</b>	
<b>100 mm Quick Chuck Bits Driver</b>	
<b>5 m Measuring Tape - Metric &amp; AF</b>	

Item ID: **TEFMDI54**



FOAM SERIES

x4
----

5 Pieces

**POWER THROUGH SCREWDRIVER SET FOAMX4**

- Chrome vanadium blades for greater strength and material flexibility
- Percussion cap and full length integral blade for use with a hammer to release stubborn screws
- Ergonomically designed bi-material handle for easy use with higher torque
- The handle is moulded around the blade to give a higher torque capacity
- Tools are held in place using three colour pre-cut high-density EVA foam
- Organised in a foam inlay module size X4 (FOAMX4)

<b>Screwdrivers:</b>
mm: 6.5 x 100    8 x 150    10 x 200
mm: PH2 x 100    PH3 x 150

Item ID: **TEXMDTN**

**BITS & DRIVER SETS**



FOAM SERIES

1
---

50 Pieces

**IMPACT BIT SET FOAM1 50 PIECES**

- Magnetic and quick chuck bit holders included for fast changing
- Designed for higher torsion
- Tools are held in place using three colour pre-cut high-density EVA foam
- Organised in a foam inlay module size 1 (FOAM1)

<b>60mm Impact magnetic bit holder,</b> <b>60mm Impact quick chuck bit holder</b>	
<b>1/4" Hex Impact Bits:</b> Length 30mm	PH1, PH2 (x2), PH3     PH2G (x2) PZ1, PZ2 (x2), PZ3     3, 4 (x2), 5, 6 TX10, TX15, TX20 (x2), TX25 (x2), TX27, TX30 (x2), TX40     1, 2
<b>1/4" Hex Impact Bits:</b> Length 50mm	PH1, PH2, PH3     3, 4, 5, 6 PZ1, PZ2, PZ3     1, 2, 3     PH2G TX10, TX15, TX20, TX25, TX27, TX30, TX40

Item ID: **TEABS50**



FOAM SERIES



78 Pieces 1/4"

**BITS DRIVER SET FOAM1 78 PIECES**

- Various drivers and accessories for use with bits and/or sockets
- Includes the TengTools mini bits ratchet adaptor for use with the quick chuck bits driver to create a reversible 1/4" drive ratchet
- Tools are held in place using three colour pre-cut high-density EVA foam
- Organised in a foam inlay module size 1 (FOAM1)

147mm Quick chuck driver, 1/4" drive ratchet head adaptor, 1/4" M x 1/4" Hex adaptor, 50mm Bit holder

1/4" Drive Regular 6 point sockets:

	mm:	4, 5, 5.5, 6, 7, 8, 9, 10, 11, 12, 13 mm
--	-----	--

1/4" Hex bits:

Length		3.5, 4.0, 4.5, 5.5 (x2), 6.5, 8.0 mm		PH2G (x3)
25mm:		PH1 (x3), PH2 (x6), PH3		ROBI, 2, 3
		TX6, TX7, TX8, TX9, TX10, TX15, TX20 (x3), TX25 (x3), TX27, TX30, TX40		
		TPX10, TPX15, TPX20 (x2), TPX25 (x2), TPX27, TPX30, TPX40		
		PZ1 (x3), PZ2 (x6), PZ3		2, 3, 4, 5, 6, 8

Item ID: **TEAMDQ78**

**HEX & TX KEYS**



FOAM SERIES



7 Pieces mm



**T-HANDLE BALL POINT HEX KEY SET FOAM2**

- Ball point end on the long key end giving access at angles of up to 25°
- Regular hex end on the short arm giving the ability to apply higher torque
- Tools are held in place using three colour pre-cut high-density EVA foam
- Organised in a foam inlay module size 2 (FOAM2)

Ball Point T-Handle Hex Drivers:

	100 mm long:	2.5, 3, 4 mm
	150 mm long:	5, 6, 7 mm
	190 mm long:	8 mm

Item ID: **TEDHEX7**



FOAM SERIES



7 Pieces

**T-HANDLE BALL POINT TX KEY SET FOAM2**

- TPX end on the long key end for use with tamper proof TPX fastenings
- Regular TX end on the short arm giving the ability to apply higher torque
- Tools are held in place using three colour pre-cut high-density EVA foam
- Organised in a foam inlay module size 2 (FOAM2)

T-Handle TX Drivers:

		100 mm long:	TX/TPX10, TX/TPX15, TX/TPX20
		150 mm long:	TX/TPX25, TX/TPX27, TX/TPX30
		190 mm long:	TX/TPX40

Item ID: **TEDTX7**

## FOAM Series | Tool Trays



FOAM SERIES



42 Pieces

mm

AF



### BALL POINT HEX & TX KEY SET FOAM2

- Includes metric and inch hex keys
- TX keys and mini TX keys
- Also includes a handy fold up key set including hex, TX and screwdriver blades
- Tools are held in place using three colour pre-cut high-density EVA foam
- Organised in a foam inlay module size 2 (FOAM2)

Ball Point Hex & TX Keys:

1.5, 2, 2.5, 3, 4, 5, 6, 7, 8, 10 mm

5/64", 3/32", 1/8", 5/32", 3/16", 7/32", 1/4", 5/16", 3/8"

TX8, TX9, TX10, TX15, TX20, TX25, TX27, TX30, TX40

Mini TX Keys:

TX6, TX7, TX8, TX9, TX10, TX15

Fold Up Key Set:

4, 5, 6mm Hex, TX25, TX30, 5.5mm Flat, PH2, PZ2

Item ID: **TEDHT42**

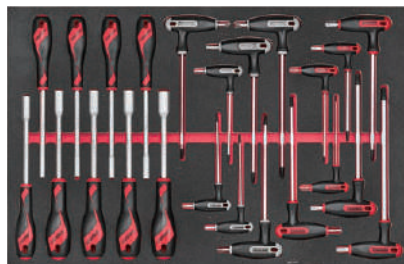

FOAM SERIES



23 Pieces

mm



### NUT DRIVER & HEX/TX T-HANDLE SET FOAM4X4

- Includes metric nut drivers and T handle hex and TX/TPX drivers
- Ergonomically designed bi-material handles for higher torque
- Hanging hole in the handle for use as a T handle for extra torque or with a fall protection wire
- The handle is moulded around the blade which gives a higher torque capacity
- Tools are held in place using three colour pre-cut high-density EVA foam
- Designed to fit exactly in the larger TengTools tool box drawers
- Organised in a foam inlay module size 4X4 (FOAM4X4)

Nut Drivers:

5, 5.5, 6, 7, 8, 10, 11, 12, 13 mm

T Handle Hex & TX Keys:

2.5, 3, 4, 5, 6, 7, 8 mm

TX/TPX10, TX/TPX15, TX/TPX20, TX/TPX25, TX/TPX27, TX/TPX30, TX/TPX40

Item ID: **TTEX23N**

**PLIERS**



FOAM SERIES



5 Pieces

TPR GRIP

**PLIER SET TPR GRIP FOAM2 5 PIECES**

- TPR grip for a more secure and comfortable grip
- All the most commonly used pliers in one set
- Tools are held in place using three colour pre-cut high-density EVA foam clearly showing where each tool belongs
- Organised in a foam inlay module size 2 (FOAM2)

Pliers:	
SIDE CUTTER	5" / 135 mm
HEAVY DUTY SIDE CUTTERS	8" / 200 mm
HIGH LEVERAGE COMBINATION	8" / 200 mm
LONG NOSE	8" / 200 mm
WATER PUMP	10" / 250 mm

Item ID: **TED441-T**



FOAM SERIES



2 Pieces

**PLIER & WRENCH SET FOAMX4 2 PIECES**

- 2 tools for gripping even the most stubborn nuts and bolts
- Tools are held in place using three colour pre-cut high-density EVA foam clearly showing where each tool belongs
- Organised in a foam inlay module size X4 (FOAMX4)

Pliers:	
Quick Action Water Pump	10" / 250 mm
Wrenches	
Aligator Adjustable	8" / 200 mm

Item ID: **TEXMB02**

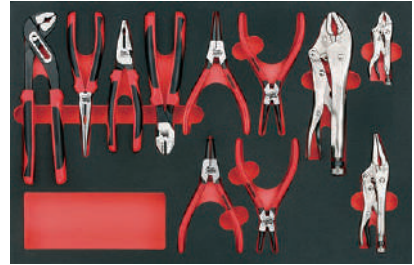

FOAM SERIES



11 Pieces

TPR GRIP

**PLIER SET FOAM4X4 11 PIECES**

- Includes all the most commonly used pliers, circlip pliers and power grip pliers in one set
- Tools are held in place using three colour pre-cut high-density EVA foam clearly showing where each tool belongs
- Designed to fit exactly in the larger TengTools tool box drawers
- Can be used as a set on it's own or as part of the TengTools Tool Control system
- Organised in a foam inlay module size 4X4 (FOAM4X4)

Pliers:	
HEAVY DUTY SIDE CUTTERS	8" / 200 mm
HIGH LEVERAGE COMBINATION	7" / 180 mm
LONG NOSE	8" / 200 mm
WATER PUMP	10" / 250 mm
Circlip Pliers:	
STRAIGHT INNER	7" / 175 mm
BENT INNER	7" / 175 mm
STRAIGHT OUTER	7" / 175 mm
BENT OUTER	7" / 175 mm
POWER GRIP Pliers:	
LONG NOSE STRAIGHT JAW	6" / 155 mm
REGULAR CURVED JAW	4" / 100 mm
	10" / 250 mm

Item ID: **TTEMB11**



## FOAM Series | Tool Trays

FOAM  
SERIES

4x4

17  
PiecesTPR  
GRIP

## PLIER SET FOAM4X4 17 PIECES

- Includes all the most commonly used pliers in one set
- TPR grip for a more secure and comfortable grip
- Circlip Pliers with vinyl grip
- Tools are held in place using three colour pre-cut high-density EVA foam clearly showing where each tool belongs
- Designed to fit exactly in the larger TengTools tool box drawers
- Can be used as a set on it's own or as part of the TengTools Tool Control system
- Organised in a foam inlay module size 4X4 (FOAM4X4)

## Pliers:

SIDE CUTTERS	5" / 135 mm
	6" / 155 mm
HEAVY DUTY SIDE CUTTERS	6" / 160 mm
	8" / 200 mm
OFFSET HEAVY DUTY SIDE CUTTERS	8" / 200 mm
CABLE CUTTERS	8" / 208 mm
HIGH LEVERAGE COMBINATION	7" / 180 mm
	8" / 200 mm
LONG NOSE	8" / 200 mm
FLAT LONG NOSE	6" / 165 mm
WIRE STRIPPERS	6" / 155 mm
WATER PUMP	7" / 180 mm
	10" / 250 mm

## Circlip Pliers:

STRAIGHT INNER	7" / 175 mm
BENT INNER	7" / 175 mm
STRAIGHT OUTER	7" / 175 mm
BENT OUTER	7" / 175 mm

Item ID: **TTEMB17**

NEW

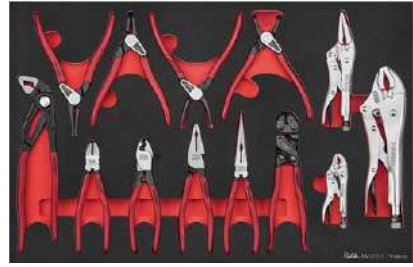
FOAM  
SERIES

4x4

13  
Pieces

## PLIER SET Q FOAM4X4 13 PIECES

- Includes all the most commonly used pliers, circlip pliers and power grip pliers in one set
- Vinyl grip for slim design allows for greater access in tight places
- Circlip pliers with invisible return spring for easier operation
- Water pump plier with Quick Set
- Power Grip Pliers are self locking with release lever and has a wire cutter and crimp function and are produced in chrome molybdenum steel
- Tools are held in place using three colour pre-cut high-density EVA foam clearly showing where each tool belongs
- Design to fit exactly in the larger TengTools tool box drawer
- Can be used as a set on its own or as a part of the TengTools Tool Control system
- Organised in a foam inlay module size 4X4 (FOAM4X4)

## Vinyl Grip Pliers:

Side Cutting Plier	6" / 155 mm
Heavy Duty Combination	7" / 180 mm
Long Nose	8" / 200 mm
Quick Set Water Pump	10" / 250 mm

## PRO Circlip Pliers:

Straight Inner	7" / 175 mm
Bent Inner	7" / 175 mm
Straight Outer	7" / 175 mm
Bent Outer	7" / 175 mm

## Power Grip Pliers:

Long Nose Straight Jaw	6" / 155 mm
Regular Curved Jaw	4" / 100 mm
	10" / 250 mm

## Cutters:

Mini Bolt Cutters	8" / 200 mm
Cable Cutter	6" / 160 mm

Item ID: **TTEMB13Q**

NEW

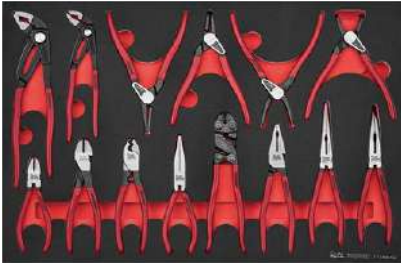

FOAM SERIES

4x4

14

Pieces

**PLIER SET VINYL GRIP Q FOAM4X4 14 PIECES**

- Includes all the most commonly used pliers in one set
- Vinyl grip for slim design allows for greater access in tight places
- Circlip pliers with invisible return spring for easier operation
- Water pump plier with Quick Set
- Tools are held in place using three colour pre-cut high-density EVA foam clearly showing where each tool belongs
- Design to fit exactly in the larger TengTools tool box drawer
- Can be used as a set on its own or as a part of the TengTools Tool Control system
- Organised in a foam inlay module size 4X4 (FOAM4X4)

Vinyl Grip Pliers:

Side Cutting Plier	5" / 135 mm
Heavy Duty Side Cutter	6" / 160 mm
Heavy Duty Combination	7" / 180 mm
Long Nose	8" / 200 mm
Bent Long Nose	8" / 200 mm
Flat Nose Plier	6" / 165 mm
Quick Set Water Pump	7" / 190 mm
Quick Set Water Pump	10" / 250 mm

PRO Circlip Pliers:

Straight Inner	7" / 175 mm
Bent Inner	7" / 175 mm
Straight Outer	7" / 175 mm
Bent Outer	7" / 175 mm

Cutters:

Mini Bolt Cutters	8" / 200 mm
Cable Cutter	6" / 160 mm

Item ID: **TTEMB14Q**



FOAM SERIES

4x4

11

Pieces

**POWER GRIP PLIER SET FOAM4X4 11 PIECES**

- Includes all the most commonly used power grip pliers and welding pliers in one set
- Tools are held in place using three colour pre-cut high-density EVA foam clearly showing where each tool belongs
- Designed to fit exactly in the larger TengTools tool box drawers
- Can be used as a set on it's own or as part of the TengTools Tool Control system
- Organised in a foam inlay module size 4X4 (FOAM4X4)

Power Grip Pliers:

	4" / 100 mm
	7" / 180 mm
STANDARD ROUND JAW	10" / 250 mm
	12" / 300 mm
STANDARD FLAT JAW	10" / 250 mm
	12" / 300 mm
	4" / 100 mm
LONG NOSE	6" / 155 mm
	9" / 230 mm
C CLAMP PLIER	11" / 285 mm
SELF LEVELLING LOCKING PLIER	12" / 300 mm

Item ID: **TTEVG11**

## FOAM Series | Tool Trays

NEW



3 Pieces

### POWER GRIP PLIER SET FOAMX2 3 PIECES

- The most commonly used power grip pliers in one set
- Self locking with release lever
- With locking nut on adjustment knob for pre-setting, ideal for repeated use
- Wire cutter and crimper function
- Chrome molybdenum
- Tools are hold in place using three colour pre-cut high-density EVA foam clearly showing where each tool belongs
- Organised in a foam inlay module size X2 (FOAMX2)

Power Grip Pliers:	
STANDARD ROUND JAW	4" / 100 mm
LONG NOSE	4" / 100 mm
	6" / 155 mm

Item ID: **TEZVG03**

## INSULATED TOOLS

NEW



10 Pieces

### INSULATED INTERCHANGEABLE BLADE SET FOAM1 10 PIECES

- Interchangeable blades for a wide range of tips in one set
- Approved for live working up to 1,000 volts
- Tools are hold in place using three colour pre-cut high-density EVA foam clearly showing where each tool belongs
- Design and manufactured to DIN5264, DIN ISO 8764 and IEC60900 (EN60900)
- Organised in a foam inlay module size 1 (FOAM1)

Insulated screwdriver handles: (S) 22x100mm, (L) 37x122mm	
1000V Insulated Screwdriver blades:	
Reg mm:	3 x 70
Slim mm:	4 x 100    5.5 x 80    6.5 x 100
Slim mm:	PH1 x 80    PH2 x 100
Slim mm:	PZ1 x 80    PZ2 x 100

Item ID: **TEAMDV10**

NEW



4 Pieces

### INSULATED SCREWDRIVER SET FLAT FOAM1 4 PIECES

- Approved for live working up to 1,000 volts
- Integrated protective insulation with two colours clearly indicate if there is any damage
- Tools are hold in place using three colour pre-cut high-density EVA foam clearly showing where each tool belongs
- Design and manufactured to DIN5264 and IEC60900 (EN60900)
- Organised in a foam inlay module size 1 (FOAM1)

1000V Insulated Screwdrivers:	
mm:	2.5 x 75    3 x 100
slim mm:	4.0 x 100    5.5 x 125

Item ID: **TEAMDV04N**

NEW



4 Pieces

### INSULATED SCREWDRIVER SET PH/PZ FOAM1 4 PIECES

- Approved for live working up to 1,000 volts
- Integrated protective insulation with two colours clearly indicate if there is any damage
- Tools are hold in place using three colour pre-cut high-density EVA foam clearly showing where each tool belongs
- Design and manufactured to DIN ISO 8764 and IEC60900 (EN60900)
- Organised in a foam inlay module size 1 (FOAM1)

1000V Insulated Screwdrivers:	
slim mm:	PH1 x 80    PH2 x 100
slim mm:	PZ1 x 80    PZ2 x 100

Item ID: **TEAMDV04N1**

NEW



TT  
SERIES



**TORQUE SCREWDRIVER BLADE SET FOAM1**

- Slim blades with reduced blade diameter for easier access to recessed screws and spring elements
- Approved for live working up to 1,000 volts
- Tools are hold in place using three colour pre-cut high-density EVA foam
- Designed and manufactured to IEC60900
- Organised in a foam inlay module size 1 (FOAM1)

1000V Insulated Torque Screwdriver 1/4 in 1-5Nm

1000V Insulated Screwdriver blades:

Reg mm:	3 x 70		
Slim mm:	4 x 100	5.5 x 80	6.5 x 100
Slim mm:	PH1 x 80	PH2 x 100	
Slim mm:	PZ1 x 80	PZ2 x 100	

Item ID: **TEAVSD09**



FOAM  
SERIES



**INSULATED PLIER SET FOAM2 4 PIECES**

- Approved for live working up to 1,000 volts
- TPR grip for a more secure and comfortable grip
- Tools are held in place using three colour pre-cut high-density EVA foam
- Designed and manufactured to DIN5745, DIN5746, DIN5749 and IEC 60900
- Organised in a foam inlay module size 2 (FOAM2)

1000V Insulated Pliers:

SIDE CUTTER	6" / 150 mm
LONG NOSE PLIERS	8" / 200 mm
COMBINATION PLIERS	8" / 200 mm
WIRE STRIPPING PLIERS	6" / 155 mm

Item ID: **TEDV440**



FOAM  
SERIES



**INSULATED SCREWDRIVER SET MIXED FOAM2**

- Approved for live working up to 1,000 volts
- Integrated protective insulation with two colours to clearly indicate if there is any damage
- A 100-250 volt tester is also included for checking circuits
- Tools are held in place using three colour pre-cut high-density EVA foam
- Designed and manufactured to DIN ISO 8764-1, DIN ISO 2380 and IEC 60900
- Organised in a foam inlay module size 2 (FOAM2)

100-250V Voltage Tester

1000V Insulated Screwdrivers:

mm:	2.5 x 75	3 x 100	4 x 100	5.5 x 125
mm:	PH0 x 60	PH1 x 80	PH2 x 100	
mm:	PZ2 x 100			

Item ID: **TEDV909N**

# FOAM Series | Tool Trays

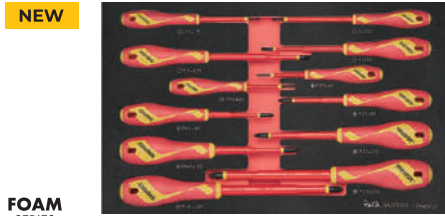

FOAM SERIES  
3

12 Pieces

## INSULATED SCREWDRIVER SET FOAM3 12 PIECES

- Approved for live working up to 1,000 volts
- Integrated protective insulation with two colours clearly indicate if there is any damage
- Tools are hold in place using three colour pre-cut high-density EVA foam clearly showing where each tool belongs
- Design to fit exactly in the TengTools service cases
- Design and manufactured to DIN5264, DIN ISO 8764 and IEC60900 (EN60900)
- Organised in a foam inlay module size 3 (FOAM3)

1000V Insulated Screwdrivers:	
	mm: 2.5 x 75 3 x 100  slim mm: PH1 x 80 PH2 x 100
	slim mm: 4.0 x 100 5.5 x 125  mm: PZ0 x 60 PZ3 x 150
	mm: PH0 x 60 PH3 x 150  slim mm: PZ1 x 80 PZ2 x 100

Item ID: **TEFMDV12**



FOAM SERIES  
2

18 Pieces

## INSULATED SOCKET SET 3/8" DRIVE 18 PIECES

- Approved for live working up to 1,000 volts
- 6 point single hexagon socket for a better grip
- Integrated protective insulation with two colours to clearly indicate if there is any damage to the insulation
- Tools are hold in place using three colour pre-cut high-density EVA foam clearly showing where each tools belongs
- Designed and manufactured to DIN, ISO and IEC 60900 standards
- Organised in a foam inlay module size 2 (FOAM2)

3/8" Drive Insulated Ratchet, 3" and 6" Insulated Extension bars	
Regular 6 point Insulated sockets:	
	mm: 6 7 8 9 10 11 12 13 14 15 16 17 18 19 20

Item ID: **TEDV3818**



FOAM SERIES  
3

11 Pieces

## INSULATED PLIER & SCREWDRIVER SET FOAM3 11 PIECES

- Approved for live working up to 1,000 volts
- Integrated protective insulation with two colours clearly indicate if there is any damage
- A 100-250 volt tester is included for checking circuits
- Tools are hold in place using three colour pre-cut high-density EVA foam clearly showing where each tool belongs
- Design to fit exactly in the TengTools service cases
- Design and manufactured to DIN5264, DIN ISO 8764 and IEC60900 (EN60900)
- Organised in a foam inlay module size 3 (FOAM3)

100-250V Voltage Tester	
1000V Insulated Screwdrivers:	1000V Insulated Pliers:
mm: 2.5 x 75	Side Cutter 6" / 150 mm
slim mm: 4.0 x 100	Long Nose Pliers 8" / 200 mm
slim mm: PH1 x 80 PH2 x 100	Combination Pliers 7" / 175 mm
slim mm: PZ1 x 80 PZ2 x 100	Wire Stripping Pliers 6" / 155 mm

Item ID: **TEFXV11**

NEW

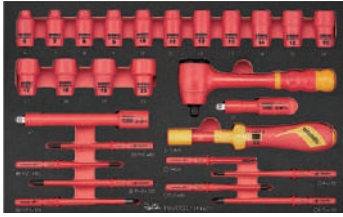

FOAM SERIES

3



**INSULATED TORQUE SCREWDRIVER SET  
FOAM3 27 PIECES**

- Approved for live working up to 1,000 volts
- Integrated protective insulation with two colours clearly indicate if there is any damage
- Tools are hold in place using three colour pre-cut high-density EVA foam clearly showing where each tool belongs
- Design to fit exactly in the TengTools service cases
- Design and manufactured to IEC60900 (EN60900)
- Organised in a foam inlay module size 3 (FOAM3)

3/8" Drive Insulated Ratchet

3" and 6" Insulated Extension bars

Regular 6 point Insulated sockets:

mm:	6	7	8	9	10	11	12	13
	14	15	16	17	18	19	20	

Torque Screwdriver 1/4 in 1-5Nm 1000V

1000V Insulated Screwdriver blades:

Reg mm:	3 x 70		
Slim mm:	4 x 100	5.5 x 80	6.5 x 100
Slim mm:	PH1 x 80	PH2 x 100	
Slim mm:	PZ1 x 80	PZ2 x 100	

Item ID: **TEFXV27**

NEW



FOAM SERIES

3



**INSULATED SOCKET & SCREWDRIVER SET  
FOAM3 28 PIECES**

- Approved for live working up to 1,000 volts
- Integrated protective insulation with two colours clearly indicate if there is any damage
- Tools are hold in place using three colour pre-cut high-density EVA foam clearly showing where each tool belongs
- Design to fit exactly in the TengTools service cases
- Design and manufactured to IEC60900 (EN60900)
- Organised in a foam inlay module size 3 (FOAM3)

3/8" Drive Insulated Ratchet

3" and 6" Insulated Extension bars

Regular 6 point Insulated sockets:

mm:	6	7	8	9	10	11	12	13
	14	15	16	17	18	19	20	

Insulated screwdriver handles: (S) 22x100mm, (L) 37x122mm

1000V Insulated Screwdriver blades:

Reg mm:	3 x 70		
Slim mm:	4 x 100	5.5 x 80	6.5 x 100
Slim mm:	PH1 x 80	PH2 x 100	
Slim mm:	PZ1 x 80	PZ2 x 100	

Item ID: **TEFXV28**

MEASURING TOOLS



FOAM SERIES



3 Pieces

MEASURING TOOL SET FOAM2 3 PIECES

- Ideal for machinists and technicians
- Includes a digital 4 function caliper, micrometer and a dial indicator complete with a magnetic stand
- Tools are held in place using three colour pre-cut high-density EVA foam
- Organised in a foam inlay module size 2 (FOAM2)

Measuring Tools:

Digital Caliper 150mm / 6"

Micrometer 0-25mm

Dial Indicator with Stand 0-10mm measuring range

Magnetic Stand with Central Locking

Item ID: **TEDIMM**

AUTO TOOLS



FOAM SERIES



5 Pieces

3/8"

mm

3/8" T BAR SPARK PLUG SOCKET SET FOAMX4

- Extra long swivelling magnetic spark plug sockets for use in hard to reach places
- T bar with the TengTools T-HD handle for more comfortable use
- Tools are held in place using three colour pre-cut high-density EVA foam
- Organised in a foam inlay module size X4 (FOAMX4)

2 Piece T-bar handle

3/8" Drive extra long swivelling spark plug sockets:

mm: 14 16 21

Item ID: **TEXTB05**



FOAM SERIES



5 Pieces

1/2"

mm

WHEEL TOOL SET FOAMX4 5 PIECES

- 17" 1/2" drive flex handle for shifting stubborn wheel nuts
- A short extension bar for reaching into recessed wheel rims
- Long reach sockets with protective nylon sleeves to avoid damage to wheels
- Tools are held in place using three colour pre-cut high-density EVA foam
- Organised in a foam inlay module size X4 (FOAMX4)

1/2" Drive Accessories:

17" Flex Handle, 5" Extension bar

Impact Wheel Nut Sockets:

17, 19, 21mm

Item ID: **TEXW05**

SERVICE TOOLS



FOAM SERIES

x	2
---	---

14 Pieces

**PUNCH & CHISEL SET FOAM2 14 PIECES**

- Flat cold chisel made from chrome molybdenum
- Pin punches made from chrome molybdenum
- Automatic centre punch with spring loaded stroke for marking points quickly
- Tools are held in place using three colour pre-cut high-density EVA foam
- Organised in a foam inlay module size 2 (FOAM2)

Punches:

Centre	Length: 150 mm	4, 5, 8 mm, Automatic centre punch
Parallel	Length: 150 mm	3, 4, 5, 6, 7, 8 mm

Flat cold chisels::

150 mm	Width: 19 mm
200 mm	Width: 25 mm
240 mm	Width: 26 mm
250 mm	Width: 25 mm

Item ID: **TEDPC14**

NEW



FOAM SERIES

x	2
---	---

6 Pieces

1/2"

**EXTRACTOR AND NUT SPLITTER SET FOAMX2 6 PIECES**

- Includes stud extractors and nut splitters
- Ideal for use with broken nuts, bolts and studs
- Tools are held in place using three colour pre-cut high-density EVA foam clearly showing where each tool belongs
- Organised in a foam inlay module size X2 (FOAMX2)

1/2" Drive Stud Extractors:

6, 8, 10, 12 mm

Nut Splitters:

5 to 20mm, 14 to 27mm

Item ID: **TEZSN06**



FOAM SERIES

x	4
---	---

4 Pieces

**PRY BAR SET ROLL/HEEL FOAMX4 4 PIECES**

- Includes 3 roll/heel bars and a 20" tyre lever
- Tools are held in place using three colour pre-cut high-density EVA foam
- Organised in a foam inlay module size X4 (FOAMX4)

Roll heel bars:

12", 16", 20"

Tyre Lever:

20"

Item ID: **TEXPB4**



FOAM SERIES

x	1
---	---

81 Pieces

**RIVET GUN SET FOAM1 81 PIECES**

- Aluminium alloy and forged steel construction
- Light weight design for more comfortable use
- PVC grip for added comfort
- Suitable for use with 2.4, 3.2, 4.0 and 4.8mm rivets
- Selection of rivets included
- Tools are held in place using three colour pre-cut high-density EVA foam
- Organised in a foam inlay module size 1 (FOAM1)

Hand rivetter:

4 nozzles to suit aluminium/steel blind rivets (2.4, 3.2, 4.0, 4.8 mm)

Aluminium rivets:

2.4mm (3/32") x 20 black  
 3.2mm (1/8") x 20 black  
 4.0mm (5/32") x 20 black  
 4.8mm (3/16") x 20 black

Accessories:

Nozzle wrench

Item ID: **TEAHR81**



# OTHER TOOL SETS



A variety of tool sets including portable solutions and wall racks

A portable tool kit can be a convenient, organised, space-saving, versatile, and cost-effective option for people who need to take their tools with them or have limited storage space



A comprehensive range of tool holders that are ideal to attach to tool panels above a bench or to mount directly on the wall. The holders are perfect for the storage of tools you use frequently, they create order and make the tools easy to reach.

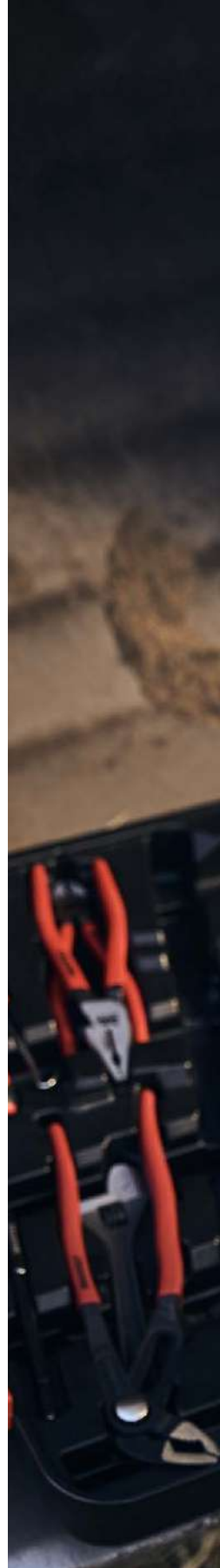

Get Organised™





105 Pieces

**HEAVY DUTY TOOL SET BP HAMMER 105 PIECES**

- 6 point 1/2" drive single hexagon sockets for a better grip
- Chrome vanadium satin finish sockets and spanners
- Combination spanners, adjustable wrenches, pliers, ball pein hammer and bits
- Supplied in a hard wearing case
- Tools clearly laid out to easily identify which tool belongs where
- Design and manufactured to DIN and ISO standards

General Tools:	
Combination	8, 10, 11, 12, 13, 14, 15, 16, 17, 18, 19,
Spanners:	21, 22, 24, 25, 26, 27, 30, 32 mm
Striking Tools:	24oz Ball pein hammer
Pliers:	6" Side cutter, 7" Heavy Duty combination plier, 10" Quick Set water pump plier
Drivers:	9 Piece mm hex key set, Ratcheting bits driver set, Flat tip screwdriver, 29 Piece bits set, 7mm ball point hex key
Wrenches:	6" & 12" Adjustable wrenches
Service Tools:	125° Hook tool, Telescopic magnetic pick up tool and pen
1/2" Drive 17" Flex Handle	
1/2" Drive FRP ratchet, 5" Extension bar	
1/2" Drive 6 point sockets:	
Reg mm:	8 10 12 13 14 15 16 17
	18 19 21 22 24 25 26 27
	30 32
1/2" Drive Hex bit sockets:	
mm:	5 6 7 8 10 12
	14 17 19

Item ID: **THDV105**



105 Pieces

**HEAVY DUTY TOOL SET E HAMMER 105 PCS**

- 6 point 1/2" drive single hexagon sockets for a better grip
- Chrome vanadium satin finish sockets and spanners
- Combination spanners, adjustable wrenches, pliers, engineers hammer and bits
- Supplied in a hard wearing case
- Tools clearly laid out to easily identify which tool belongs where
- Design and manufactured to DIN and ISO standards

General Tools:	
Combination	8, 10, 11, 12, 13, 14, 15, 16, 17, 18, 19,
Spanners:	21, 22, 24, 25, 26, 27, 30, 32 mm
Striking Tools:	800g Engineers hammer
Pliers:	6" Side cutter, 7" Heavy Duty combination plier, 10" Quick Set water pump plier
Drivers:	9 Piece mm hex key set, Ratcheting bits driver set, Flat tip screwdriver, 29 Piece bits set, 7mm ball point hex key
Wrenches:	6" & 12" Adjustable wrenches
Service Tools:	125° Hook tool, Telescopic magnetic pick up tool and pen
1/2" Drive 17" Flex Handle	
1/2" Drive FRP ratchet, 5" Extension bar	
1/2" Drive 6 point sockets:	
Reg mm:	8 10 12 13 14 15 16 17
	18 19 21 22 24 25 26 27
	30 32
1/2" Drive Hex bit sockets:	
mm:	5 6 7 8 10 12
	14 17 19

Item ID: **THDV105E**



**187**  
Pieces

### BARN STYLE TOOL BOX TOOL KIT 187 PIECES

- A comprehensive selection of tools for mechanics
- Supplied in the TengTools barn style tool box with aluminium clip rails and tools storage areas
- Padlock facility and full length piano hinges with turned edges for added safety

1/4" Drive	30 socket clips, FRP ratchet, universal joint, 2" & 4" extensions, 3/8"F:1/4"M adaptor, coupler adaptor
3/8" Drive	30 socket clips, FRP ratchet, universal joint, 6" extension, 1/2"F:3/8"M adaptor
1/2" Drive	30 socket clips, FRP ratchet, universal joint, 2-1/2" and 6" extensions, 3/8"F:1/2"M adaptor
1/4" Drive 6 point sockets:	
Regular:	4, 5, 5.5, 6, 7, 8, 10, 11, 12, 13mm
Deep:	6, 7, 8, 10, 12, 13mm
3/8" Drive 6 point sockets:	
Regular:	8, 9, 10, 11, 12, 13, 14, 15, 16, 17, 18, 19, 21, 22mm
1/2" Drive 12 point sockets:	
Regular:	10, 11, 12, 13, 14, 15, 16, 17, 18, 19, 21, 22, 24, 27, 30, 32mm
1/4" Hex Bits:	TX8, TX10, TX15, TX20, TX25, TX27, TX30, TX40, 3mm, 4mm, 5mm, 6mm, 7mm, 8mm, 10mm Hex, PH1, PH2, PZ1, PZ2, 4mm, 5.5mm, 7mm flat
Spanners:	8, 10, 11, 12, 13, 14, 15, 17, 19mm Ring holder
Hex Keys:	1.5, 2.0, 2.5mm hex keys

Item ID: **TC187**



**144**  
Pieces

### CANTILEVER BOX TOOL KIT 144 PIECES

- A comprehensive selection of tools for service technicians
- Supplied in the TengTools 5 drawer cantilever tool box
- Padlock facility and full length piano hinges with turned edges for added safety

1/4" Drive	FRP ratchet, universal joint, 2" and 4" extension bars, coupler adaptor, 3/8"F:1/4"M adaptor
1/2" Drive	FRP ratchet, universal joint, 2 1/2" and 6" extension bars, 3/8"F:1/2"M T bar adaptor
1/4" Drive 6 point sockets:	
Regular:	4, 5, 5.5, 6, 7, 8, 10, 11, 12, 13mm
Deep:	6, 7, 8, 10, 12, 13mm
1/2" Drive 12 point sockets:	
Regular:	10, 11, 12, 13, 14, 15, 16, 17, 18, 19, 21, 22, 24, 27, 30, 32mm
1/4" Hex Bits:	TX10, TX15, TX20, 5mm hex, 6mm hex, PH1, PH2, PZ1, PZ2, 4mm flat, 5.5mm flat
Spanners:	5.5, 6, 7, 8, 9, 10, 11, 12, 13, 14, 15, 16, 17, 18, 19mm
Hex Keys:	9 piece ball point hex key set, 1.5, 2.0 & 2.5mm hex keys, 10" adjustable wrench
Screwdrivers:	3.5mm, 5.5mm & 6.5mm flat, PH0, PH1, PH2, PZ0, PZ1, PZ2, 4mm flat 1000 volt insulated
Pliers:	8" combination, 8" long nose, 10" water pump, 6" side cutters, 8" side cutters, 10" power grip
Service Tools:	Drill bit set, magnetic lamp, measuring tape, hacksaw with spare blades, utility knife, centre punch, parallel pin punch set, soft face hammer, ball peen hammer, tin snips, magnetic bracelet

Item ID: **TC144D**



Top



Drawer 1



Drawer 2

35 Pieces

**MINI TOP BOX TOOL KIT 35 PIECES RED**

- A selection of general hand tools in PS modules
- Supplied in a 2 drawer mini top box with 2 small drawers and storage space in the top compartment
- Drop front with the TengTools logo to cover the drawers when the box is closed

Contents:

Drawer Number	Description
Top	1/4" drive regular sockets: 4, 5, 5.5, 6, 7, 8, 10, 12, 13mm 1/4" drive 2" extension, 1/4" bit ratchet 1/4" hex adaptor 1/4" hex bits: 4, 5.5, 6.5mm flat, PH1, PH2, PZ1, PZ2, TX10, TX15, TX20 Fold up bicycle tool set 4" Adjustable Wrench
Drawer 1	6" side cutter, 7" High leverage combination plier
Drawer 2	Combination spanners: 8, 9, 10, 11, 12, 13mm Screwdrivers: flat 5.5x75mm, PH1x75mm, insulated PH1 X 80mm

Item ID: **TM035NF**



144 Pieces

**BACK PACK TOOL KIT 144 PIECES**

- A comprehensive selection of tools for service technicians
- Supplied in the TengTools back pack for tools
- Shoulder straps and carrying handles make the kit easy to carry around
- Manufactured in polyester with an EVA plastic base, external pockets and a large internal compartment

1/4" Drive	FRP ratchet, universal joint, 2" and 4" extension bars, coupler adaptor, 3/8" F:1/4" M adaptor
1/2" Drive	FRP ratchet, universal joint, 2 1/2" and 6" extension bars, 3/8" F:1/2" M T bar adaptor
1/4" Drive 6 point sockets:	
Regular:	4, 5, 5.5, 6, 7, 8, 10, 11, 12, 13mm
Deep:	6, 7, 8, 10, 12, 13mm
1/2" Drive 12 point sockets:	
Regular:	10, 11, 12, 13, 14, 15, 16, 17, 18, 19, 21, 22, 24, 27, 30, 32mm
1/4" Hex Bits:	TX10, TX15, TX20, 5mm hex, 6mm hex, PH1, PH2, PZ1, PZ2, 4mm flat, 5.5mm flat
Spanners:	5.5, 6, 7, 8, 9, 10, 11, 12, 13, 14, 15, 16, 17, 18, 19mm
Wrenches:	9 piece ball point hex key set, 1.5, 2.0 & 2.5mm hex keys, 10" adjustable wrench
Screw-drivers:	3.5mm, 5.5mm & 6.5mm flat, PH0, PH1, PH2, PZ0, PZ1, PZ2, 4mm flat 1000 volt insulated
Pliers:	8" combination, 8" long nose, 10" water pump, 6" side cutters, 8" side cutters, 10" power grip
Service Tools:	Drill bit set, magnetic lamp, measuring tape, hacksaw with spare blades, utility knife, centre punch, parallel pin punch set, soft face hammer, ball pein hammer, tin snips, magnetic bracelet

Item ID: **TC144E**



12 Pieces mm

### COMBINATION SPANNER ANTI SLIP WALL RACK

- Off set at 15° for easier use on flat surfaces
- TengTools hip grip design on the ring and open end for contact with the flat side of the fastening
- TengTools anti slip design on the open end to give a much better grip
- Supplied with a wall rack for fixing to the wall or a workbench

Anti Slip Combination Spanners:

8, 9, 10, 11, 12, 13, 14, 15, 16, 17, 18, 19 mm



Item ID: **WR8012**



12 Pieces mm

### LONG COMBINATION SPANNER WALL RACK

- Extra long for increased torque
- Off set at 15° for easier use on flat surfaces
- TengTools hip grip design for contact with the flat side of the fastening
- Supplied with a wall rack for fixing to the wall or a workbench
- Designed and manufactured to DIN3113A

Long Combination Spanners:

8, 9, 10, 11, 12, 13, 14, 15, 16, 17, 18, 19 mm

Item ID: **WRSP12LMP**



12 Pieces mm

### COMBINATION SPANNER 8-19 MM WALL RACK

- Off set at 15° for easier use on flat surfaces
- TengTools hip grip design for contact with the flat side of the fastening
- Chrome vanadium satin finish
- Supplied with a wall rack for fixing to the wall or a workbench
- Designed and manufactured to DIN3113A

Combination Spanners:

8, 9, 10, 11, 12, 13, 14, 15, 16, 17, 18, 19 mm

Item ID: **WRSP12**



12 Pieces mm

### RATCHETING COMBI SPANNER RS WALL RACK

- 72 teeth ratchet spanners giving a 5° increment between clicks
- Simply turn over to reverse the direction of use when ratcheting
- Chrome vanadium satin finish
- Supplied with a wall rack for fixing to the wall or a workbench
- Designed and manufactured to DIN ISO 1711-1 and DIN 3113A

Ratchet Spanners:

8, 9, 10, 11, 12, 13, 14, 15, 16, 17, 18, 19 mm

Item ID: **WRSP12RS**





5 Pieces mm

**LONG DOUBLE RING SPANNER WALL RACK**

- Different size at each end to give 10 sizes in total
- Extra long, flat design for extra torque and easier access
- Chrome vanadium satin finish
- TengTools hip grip design for contact with the flat side of the fastening
- Supplied with a wall rack for fixing to the wall or a workbench

Extra long Double Ring Spanners:

8x10, 11x13, 12x14, 17x19, 22x24 mm

Item ID: **WRFLS05**



6 Pieces mm

**DOUBLE FLEX WRENCH SET WALL RACK**

- Swivel end wrenches for fast pre-tightening and loosening
- Angle at 90° for added torque when applying the final tightening
- Extra torque for loosening stubborn fastenings
- Chrome vanadium satin finish
- Supplied with a wall rack for fixing to the wall or a workbench

Double Flex Wrenches

8x9, 10x11, 12x13, 14x15, 16x17, 18x19 mm

Item ID: **WRDF06**



10 Pieces - + \*

**SCREWDRIVER SET WALL RACK 10 PIECES**

- TT-MV PLUS steel alloy for greater strength and material flexibility
- Ergonomically designed bi-material handle for easy use with higher torque
- The handle is moulded around the blade to ensure straightness
- Supplied with a wall rack for fixing to the wall or a workbench

Screwdrivers:

-	mm:	3 x 100	5.5 x 75	5.5 x 150
		6.5 x 150	8 x 150	
+	mm:	PH0 x 75	PH1 x 75	PH2 x 100
*	mm:	PZ1 x 75	PZ2 x 100	

Item ID: **WRMD10N**





5 Pieces  

### POWER THROUGH SCREWDRIVER WALL RACK

- Chrome vanadium blades for greater strength
- Percussion cap and full length integral blade for use with a hammer
- Ergonomically designed bi-material handle for easy use with higher torque
- The handle is moulded around the blade to ensure straightness
- Supplied with a wall rack for fixing to the wall or a workbench

Power Through Screwdrivers:

	mm:	6.5 x 100	8 x 150	10 x 200
	mm:	PH2 x 100	PH3 x 150	

Item ID: **WRMDT05N**





7 Pieces  



### T-HANDLE BALL POINT HEX KEY AF WALL RACK

- Ball point end on the long key end giving access at angles of up to 25°
- Regular hex end on the short arm to apply higher torque to stubborn fastenings
- Supplied with a wall rack for fixing to the wall or a workbench
- Template and fixings included

Ball Point T-Handle Hex Drivers:

	100 mm long:	3/32", 1/8", 5/32"
	150 mm long:	3/16", 7/32", 1/4"
	190 mm long:	5/16"

Item ID: **WRHEX07AF**





7 Pieces  



### T-HANDLE BALL POINT HEX KEY WALL RACK

- Ball point end on the long key end giving access at angles of up to 25°
- Regular hex end on the short arm to apply higher torque to stubborn fastenings
- Supplied with a wall rack for fixing to the wall or a workbench

Ball Point T-Handle Hex Drivers:

	100 mm long:	2.5, 3, 4 mm
	150 mm long:	5, 6, 7 mm
	190 mm long:	8 mm

Item ID: **WRHEX07**









7 Pieces  

### T-HANDLE TX/TPX KEY WALL RACK

- TPX type on the long key end for tamper proof TX fastenings
- Regular TX end on the short arm to apply higher torque to stubborn fastenings
- Supplied with a wall rack for fixing to the wall or a workbench

T-Handle TX Drivers:

 	100 mm long:	TX/TPX10, TX/TPX15, TX/TPX20
 	150 mm long:	TX/TPX25, TX/TPX27, TX/TPX30
 	190 mm long:	TX/TPX40

Item ID: **WRTX07**





4 Pieces TPR GRIP

**PLIER SET WALL RACK 4 PIECES**

- TPR grip for a more secure and comfortable grip
- All the most commonly used pliers in one set
- Supplied with a wall rack for fixing to the wall or a workbench

Pliers:	
SIDE CUTTER	6" / 155 mm
HIGH LEVERAGE COMBINATION PLIERS	7" / 180 mm
LONG NOSE PLIERS	8" / 200 mm
WATER PUMP PLIERS	10" / 250 mm

Item ID: **WRMB04**

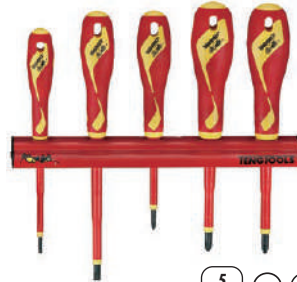

5 Pieces

**INSULATED SCREWDRIVER MIXED WALL RACK**

- Approved for live working up to 1,000 volts
- Protective insulation with two colours to clearly indicate if there is any damage to the insulation
- Supplied with a wall rack for fixing to the wall or a workbench
- Designed and manufactured to DIN ISO 2380, DIN ISO 8764-1 and IEC60900

1000V Insulated Screwdrivers:		
mm:	3 x 100	5.5 x 125
mm:	PH1 x 80	PH2 x 100
mm:	PZ2 x 100	

Item ID: **WRMDV05N**



7 Pieces

**INSULATED SCREWDRIVER FLAT & PH WALL RACK**

- Approved for live working up to 1,000 volts
- Protective insulation with two colours to clearly indicate if there is any damage to the insulation
- Supplied with a wall rack for fixing to the wall or a workbench
- Designed and manufactured to DIN ISO 2380, DIN ISO 8764-1 and IEC60900

105 - 250V Voltage Tester	
1000V Insulated Screwdrivers:	
mm:	2.5 x 75    3 x 100    4 x 100    5.5 x 125
mm:	PH1 x 80    PH2 x 100

Item ID: **WRMDV07N**



4 Pieces TPR GRIP

**INSULATED PLIER SET WALL RACK 4 PIECES**

- Approved for live working up to 1,000 volts
- TPR grip for a more secure and comfortable grip
- Supplied with a wall rack for fixing to the wall or a workbench
- Designed and manufactured to DIN5745, DIN5746, DIN5749 and IEC60900

1000V Insulated Pliers:	
SIDE CUTTER	6" / 150 mm
HEAVY DUTY SIDE CUTTER	8" / 200 mm
LONG NOSE PLIERS	8" / 200 mm
COMBINATION PLIERS	7" / 175 mm

Item ID: **WRMBV04**



5  
Pieces

**HAND FILE SET WALL RACK 5 PIECES**

- 10" high carbon steel hand files
- Bi-material handle for a more comfortable grip
- 2nd cut to create a diamond pattern cutting surface for smoother filing
- Cut on both edges of the flat files for filing grooves, etc
- Supplied with a wall rack for fixing to the wall or a workbench

10" Files:  
Flat, Hand, Half Round, Round, Three square

Item ID: **WRFL05**



10  
Pieces

**PUNCH & CHISEL SET WALL RACK 10 PIECES**

- Flat cold chisel made from chrome molybdenum
- Pin punches made from chrome molybdenum
- Supplied with a wall rack for fixing to the wall or a workbench

Punches:		
Centre	Length: 150 mm	5 mm
Parallel	Length: 150 mm	3, 4, 5, 6, 7, 8 mm
Flat cold chisels:		
150 mm		Width: 19 mm
200 mm		Width: 25 mm
250 mm		Width: 25 mm

Item ID: **WRPC10**









# TOOL STORAGE

## Built to last

TengTools tool boxes and tool cabinets have been designed to meet the high demands made by professionals from all over the world. No details are left to chance when our tool boxes and roller cabinets are manufactured.

A full range of storage accessories, side tables, side drawers and tool panels are available and can be placed on both sides of all TengTools roller cabinets.

-  All of our tool storage is manufactured from heavy gauge, top quality steel. They are built to last!
-  During the manufacturing process our tool storage is powder coat painted with a 5-step rust prevention and undercoat
-  Improved combination locking system for extra security on all PRO tool boxes and roller cabinets.
-  All drawers are equipped with robust 3-step ball bearing slides allowing them to be fully extended easily to gain greater access to the tools
-  Comfort grip handles. These top & middle boxes are supplied with rubber coated side handles while these tool cabinets are equipped with rubber soft grip transport handles
-  Cabinets are fitted with castor wheels covered with high-quality rubber. Two fixed and two swivel with brakes. Fitted in a U-shaped bracket providing extra strength and stability.



Get Organised™





### 26" PRO STACK 16 DRAWERS RED

- A red TengTools 26" 6 drawer top box, a red 26" 3 drawer middle box and red 26" 7 drawer roller cabinet combined to create a stack system with 16 drawers
- Each full width drawer in the top and middle box is suitable for holding 4 TengTools TC1 modules
- The roller cabinet drawers will also hold a TCX4 module as well as the 4 TC1 modules
- Each drawer is supplied with an EVA drawer mat
- A handy lightweight plastic and aluminium tote tray is included
- Drawers have ball bearing slides for a smoother and more reliable opening and closing action
- Use with the tool modules from the TT Series or FOAM Series in the TengTools Tool Control system to build your ultimate tool kit

-  **16 Drawer**
-  **5" Castor Wheels with Brakes**
-  **26" Wide Cabinet**
-  **3 Step Ball Bearing Slides**
-  **Heavy Gauge Steel**
-  **Comfort Grip Handle**
-  **5-Step Rust Protection**
-  **Combination Lock**

Item ID: **TC816STACK**



### 26" PRO STACK 19 DRAWERS BLACK

- A black TengTools 26" 6 drawer top box that can be personalised, a black 26" 3 drawer middle box and a black 26" 10 drawer roller cabinet combined to create a stack system with 19 drawers
- Each full width drawer in the top and middle box is suitable for holding 4 TengTools TC1 modules
- The roller cabinet drawers will also hold a TengTools TCX4 tray as well as the 4 TC1 modules
- Each drawer is supplied with an EVA drawer mat
- A handy lightweight plastic and aluminium tote tray is included
- Drawers have ball bearing slides for a smoother and more reliable opening and closing action
- Use with the tool modules from the TT Series or FOAM Series in the TengTools Tool Control system to build your ultimate tool kit

-  **19 Drawer**
-  **5" Castor Wheels with Brakes**
-  **26" Wide Cabinet**
-  **3 Step Ball Bearing Slides**
-  **Heavy Gauge Steel**
-  **Comfort Grip Handle**
-  **5-Step Rust Protection**
-  **Combination Lock**

ITEM ID:	Description
TC819NBK	Black Tool Kit with TengTools Logo sticker
TC819BK	Black Tool Kit with a custom tool box sticker

**26" STD STACK 16 DRAWERS RED**

- A red TengTools 26" 6 drawer standard top box, a red 26" 3 drawer standard middle box and a 26" 7 drawer standard roller cabinet combined to create a stack system with 16 drawers
- Each full width drawer in the top and middle box is suitable for holding 4 TengTools TC1 modules
- The roller cabinet drawers will also hold a TengTools TCX4 module as well as the 4 TC1 modules
- Drawers have ball bearing slides for a smoother and more reliable opening and closing action
- Use with the tool modules from the TT Series or FOAM Series in the TengTools Tool Control system to build your ultimate tool kit

-  **16 Drawer**
-  **26" Wide Cabinet**
-  **Heavy Gauge Steel**
-  **5-Step Rust Protection**
-  **5" Castor Wheels with Brakes**
-  **3 Step Ball Bearing Slides**
-  **Key Lock**



Item ID: **TC816SV****A Personalised Tool Box Sticker**

This is now available to you through your local stockist. Provide an image that you would like to use and we will customise your tool kit for you. Images need to be supplied as high resolution jpeg, eps, PDF, or ai vector format.



### 53" PRO STACK 16 DRAWERS RED

- A red TengTools 53" 10 drawer top box and a red TengTools 53" 6 drawer roller cabinet combined to create a stack system with 16 drawers
- The full width drawers are suitable for holding 8 TengTools TC1 modules plus 2 TCX4 modules
- Each drawer is supplied with an EVA drawer mat and plastic trimmed handle
- Drawers have ball bearing slides for a smoother and more reliable opening and closing action
- Use with the tool modules from the TT Series or FOAM Series in the TengTools Tool Control system to build your ultimate tool kit

- |   |   |
|---|---|
|  <b>16 Drawer</b>              |  <b>6" Castor Wheels with Brakes</b> |
|  <b>53" Wide Cabinet</b>       |  <b>3 Step Ball Bearing Slides</b>   |
|  <b>Heavy Gauge Steel</b>      |  <b>Comfort Grip Handle</b>          |
|  <b>5-Step Rust Protection</b> |  <b>Combination Lock</b>             |

Item ID: TCW816LNSTACK



### 53" PRO STACK 19 DRAWERS RED

- A red TengTools 53" 10 drawer top box and a red TengTools 53" 9 drawer roller cabinet combined to create a stack system with 19 drawers
- Each full width drawer is suitable for holding 4 TengTools TC1 modules plus a TCX4 module
- The full width drawers are suitable for holding 8 TengTools TC1 modules plus 2 TCX4 modules
- Each drawer is supplied with an EVA drawer mat and plastic trimmed handle
- Drawers have ball bearing slides for a smoother and more reliable opening and closing action
- Use with the tool modules from the TT Series or FOAM Series in the TengTools Tool Control system to build your ultimate tool kit







- |   |   |
|---|---|
|  <b>19 Drawer</b>              |  <b>6" Castor Wheels with Brakes</b> |
|  <b>53" Wide Cabinet</b>       |  <b>3 Step Ball Bearing Slides</b>   |
|  <b>Heavy Gauge Steel</b>      |  <b>Comfort Grip Handle</b>          |
|  <b>5-Step Rust Protection</b> |  <b>Combination Lock</b>             |

Item ID: TCW819STACK

### 26" PRO TOP BOX 6 DRAWERS RED

- Drop front with the TengTools logo to cover the drawers when the box is closed
- Each full width drawer is suitable for holding 4 TengTools TCI modules
- Supplied with an EVA drawer mat and plastic trimmed handle
- A handy lightweight plastic and aluminium tote tray is included
- Drawers have ball bearing slides for a smoother and more reliable opening and closing action
- Supplied with rubber feet to prevent it from sliding and to avoid scratching
- Use with the tool modules from the TT Series or FOAM Series in the TengTools Tool Control system to build your ultimate tool kit



-  **6 Drawer**
-  **3 Step Ball Bearing Slides**
-  **26" Wide Box**
-  **Comfort Grip Handle**
-  **Heavy Gauge Steel**
-  **Combination Lock**
-  **5-Step Rust Protection**

	Width mm	Depth mm	Height mm	Capacity kg
Overall	660	305	375	
Drawer 1	170	275	50	8
Drawer 2	170	275	50	8
Drawer 3	170	275	50	8
Drawer 4	569	275	50	30
Drawer 5	569	275	50	30
Drawer 6	569	275	75	30







Drawer thickness mm	0.7
Body frame thickness mm	0.8
Weight kg	23.4

ITEM ID:	Description
TC806NF	Red Tool Box with TengTools Logo sticker
TC806NFR	Red Tool Box with a custom tool box sticker

### 26" PRO TOP BOX 6 DRAWERS BLACK

- Drop front with the TengTools logo to cover the drawers when the box is closed
- Each full width drawer is suitable for holding 4 TengTools TCI modules
- Supplied with an EVA drawer mat and plastic trimmed handle
- A handy lightweight plastic and aluminium tote tray is included
- Drawers have ball bearing slides for a smoother and more reliable opening and closing action
- Supplied with rubber feet to prevent it from sliding and to avoid scratching
- Use with the tool modules from the TT Series or FOAM Series in the TengTools Tool Control system to build your ultimate tool kit



-  **6 Drawer**
-  **3 Step Ball Bearing Slides**
-  **26" Wide Box**
-  **Comfort Grip Handle**
-  **Heavy Gauge Steel**
-  **Combination Lock**
-  **5-Step Rust Protection**

	Width mm	Depth mm	Height mm	Capacity kg
Overall	660	305	375	
Drawer 1	170	275	50	8
Drawer 2	170	275	50	8
Drawer 3	170	275	50	8
Drawer 4	569	275	50	30
Drawer 5	569	275	50	30
Drawer 6	569	275	75	30

Drawer thickness mm	0.7
Body frame thickness mm	0.8
Weight kg	23.4

ITEM ID:	Description
TC806NBK	Black Tool Box with TengTools Logo sticker
TC806NGM	Black Tool Box with a custom tool box sticker





- 6 Drawer**
- 26" Wide Box**
- Heavy Gauge Steel**
- 5-Step Rust Protection**
- 3 Step Ball Bearing Slides**
- Key Lock**

Item ID: **TC806SV**

### 26" STD TOP BOX 6 DRAWERS RED

- Drop front with the TengTools logo to cover the drawers when the box is closed
- Each full width drawer is suitable for holding 4 TengTools TCI modules or equivalent
- Drawers have ball bearing slides for a smoother and more reliable opening and closing action
- Supplied with rubber feet to prevent it from sliding and to avoid scratching
- Use with the tool modules from the TT Series or FOAM Series in the TengTools Tool Control system to build your ultimate tool kit

	Width mm	Depth mm	Height mm	Capacity kg	Drawer thickness mm
Overall	660	305	375		0.7
Drawer 1	170	275	50	8	Body frame thickness mm
Drawer 2	170	275	50	8	
Drawer 3	170	275	50	8	0.8
Drawer 4	569	275	50	30	Weight kg
Drawer 5	569	275	50	30	
Drawer 6	569	275	75	30	23.4



- 5 Drawer**
- 26" Wide Box**
- Heavy Gauge Steel**
- 5-Step Rust Protection**
- 3 Step Ball Bearing Slides**
- Comfort Grip Handle**
- Combination Lock**

Item ID: **TC805NFX**

### 26" PRO FULL DEPTH TOP BOX 5 DRAWERS RED

- 5 full width drawers
- Drop front with the TengTools logo to cover the drawers when the box is closed
- Each drawer is suitable for holding 4 TengTools TCI modules plus a Tengtools TCX4 module
- A handy lightweight plastic and aluminium tote tray is included
- Drawers have ball bearing slides for a smoother and more reliable opening and closing action
- Supplied with rubber feet to prevent it from sliding and to avoid scratching
- Use with the tool modules from the TT Series or FOAM Series in the TengTools Tool Control system to build your ultimate tool kit

	Width mm	Depth mm	Height mm	Capacity kg	Drawer thickness mm
Overall	660	455	483		1
Drawer 1	575	380	50	30	Body frame thickness mm
Drawer 2	575	380	50	30	
Drawer 3	575	380	75	30	1
Drawer 4	575	380	75	30	Weight kg
Drawer 5	575	380	75	30	
					44

### 26" STD FULL DEPTH TOP BOX 5 DRAWERS RED

- 5 full width drawers
- Drop front with the TengTools logo to cover the drawers when the box is closed
- Each drawer is suitable for holding 4 TengTools TC1 modules plus a TengTools TCX4 module
- Drawers have ball bearing slides for a smoother and more reliable opening and closing action
- Supplied with rubber feet to prevent it from sliding and to avoid scratching
- Use with the tool modules from the TT Series or FOAM Series in the TengTools Tool Control system to build your ultimate tool kit

	Width mm	Depth mm	Height mm	Capacity kg	Drawer thickness mm
Overall	660	455	483		1
Drawer 1	575	380	50	30	Body frame thickness mm
Drawer 2	575	380	50	30	1
Drawer 3	575	380	75	30	Weight kg
Drawer 4	575	380	75	30	44
Drawer 5	575	380	75	30	



- 5 Drawer**
- 26" Wide Box**
- Heavy Gauge Steel**
- 5-Step Rust Protection**
- 3 Step Ball Bearing Slides**
- Key Lock**

Item ID: **TC805SV**

### 37" PRO TOP BOX 5 DRAWERS RED

- Each full width drawer is suitable for holding 4 TengTools TC1 modules together with a TCX4 module and a TCX2 module
- Supplied with EVA drawer mats and plastic trimmed handles
- Drawers have ball bearing slides for a smoother and more reliable opening and closing action
- Use with the tool modules from the TT Series or FOAM Series in the TengTools Tool Control system to build your ultimate tool kit







	Width mm	Depth mm	Height mm	Capacity kg	Drawer thickness mm
Overall	943	455	483		1
Drawer 1	860	380	50	25	Body frame thickness mm
Drawer 2	860	380	50	25	1.2
Drawer 3	860	380	50	25	Weight kg
Drawer 4	860	380	75	25	56.7
Drawer 5	860	380	75	25	



- 5 Drawer**
- 37" Wide Box**
- Heavy Gauge Steel**
- 5-Step Rust Protection**
- 3 Step Ball Bearing Slides**
- Comfort Grip Handle**
- Combination Lock**

Item ID: **TC205NF**



-  **10 Drawer**
-  **53" Wide Box**
-  **Heavy Gauge Steel**
-  **5-Step Rust Protection**
-  **3 Step Ball Bearing Slides**
-  **Comfort Grip Handle**
-  **Combination Lock**







Item ID: **TC810N**

### 53" PRO TOP BOX 10 DRAWERS RED

- Each drawer is suitable for holding 4 TengTools TCI module plus a TengTools TCX4 module
- Supplied with an EVA drawer mat and plastic trimmed handle
- Drawers have ball bearing slides for a smoother and more reliable opening and closing action
- Supplied with rubber feet to prevent it from sliding and to avoid scratching
- Use with the tool modules from the TT Series or FOAM Series in the TengTools Tool Control system to build your ultimate tool kit

	Width mm	Depth mm	Height mm	Capacity kg	Drawer thickness mm
Overall	1337	455	560		0.7
Drawer 1	575	380	75	30	Body frame thickness mm
Drawer 2	575	380	75	30	
Drawer 3	575	380	75	30	Weight kg
Drawer 4	575	380	75	30	
Drawer 5	575	380	75	30	
Drawer 6	575	380	75	30	
Drawer 7	575	380	75	30	
Drawer 8	575	380	75	30	
Drawer 9	575	380	75	30	
Drawer 10	575	380	75	30	



-  **3 Drawer**
-  **26" Wide Box**
-  **Heavy Gauge Steel**
-  **5-Step Rust Protection**
-  **3 Step Ball Bearing Slides**
-  **Comfort Grip Handle**
-  **Combination Lock**

Item ID: **TC803N**

### 26" PRO MIDDLE BOX 3 DRAWERS RED

- Each full width drawer is suitable for holding 4 TengTools TCI modules
- Supplied with EVA drawer mats and plastic trimmed handles
- Drawers have ball bearing slides for a smoother and more reliable opening and closing action
- Supplied with rubber feet to prevent it from sliding and to avoid scratching
- Use with the tool modules from the TT Series or FOAM Series in the TengTools Tool Control system to build your ultimate tool kit

	Width mm	Depth mm	Height mm	Capacity kg	Drawer thickness mm
Overall	660	305	250		0.7
Drawer 1	569	275	50	30	Body frame thickness mm
Drawer 2	569	275	50	30	
Drawer 3	569	275	75	30	Weight kg

### 26" PRO MIDDLE BOX 3 DRAWERS BLACK

- Each full width drawer is suitable for holding 4 TengTools TC1 modules
- Supplied with an EVA drawer mat and plastic trimmed handle
- Drawers have ball bearing slides for a smoother and more reliable opening and closing action
- Supplied with rubber feet to prevent it from sliding and to avoid scratching
- Use with the tool modules from the TT Series or FOAM Series in the TengTools Tool Control system to build your ultimate tool kit



	Width mm	Depth mm	Height mm	Capacity kg
Overall	660	305	250	
Drawer 1	569	275	50	30
Drawer 2	569	275	50	30
Drawer 3	569	275	75	30

Drawer thickness mm	0.7
Body frame thickness mm	0.8
Weight kg	13

-  **26" Wide Box**
-  **3 Step Ball Bearing Slides**
-  **Heavy Gauge Steel**
-  **Comfort Grip Handle**
-  **5-Step Rust Protection**
-  **Combination Lock**

Item ID: **TC803NBK**

### 26" STD MIDDLE BOX 3 DRAWERS RED

- Each full width drawer is suitable for holding 4 TengTools TC1 modules
- Drawers have ball bearing slides for a smoother and more reliable opening and closing action
- Supplied with rubber feet to prevent it from sliding and to avoid scratching
- Use with the tool modules from the TT Series or FOAM Series in the TengTools Tool Control system to build your ultimate tool kit



	Width mm	Depth mm	Height mm	Capacity kg
Overall	660	305	250	
Drawer 1	569	275	50	30
Drawer 2	569	275	50	30
Drawer 3	569	275	75	30

Drawer thickness mm	0.7
Body frame thickness mm	0.8
Weight kg	13

-  **3 Drawer**
-  **5-Step Rust Protection**
-  **26" Wide Box**
-  **3 Step Ball Bearing Slides**
-  **Heavy Gauge Steel**
-  **Key Lock**

Item ID: **TC803SV**



-  **3 Drawer**
-  **4" Castor Wheels with Brakes**
-  **26" Wide Cabinet**
-  **3 Step Ball Bearing Slides**
-  **Heavy Gauge Steel**
-  **Comfort Grip Handle**
-  **5-Step Rust Protection**
-  **Combination Lock**

Item ID: **TCW803N**

### 26" PRO LOW HEIGHT CABINET 3 DRAWERS RED

- Two 75mm deep drawers and one 150mm deep for storing larger items
- Storage compartment in the base fitted with a TengTools combination lock for secure storage of larger items
- Low height making it ideal for use beneath a low workbench
- Each drawer is suitable for holding 4 TengTools TC1 modules plus a TengTools TCX4 module
- Supplied with an ABS top mat and EVA drawer mats in each drawer
- Drawers have ball bearing slides for a smoother and more reliable opening and closing action
- Use with the tool modules from the TT Series or FOAM Series in the TengTools Tool Control system to build your ultimate tool kit

	Width mm	Depth mm	Height mm	Capacity kg	Drawer thickness mm
Cabinet	670	460	656		1
Cabinet + Wheels	670	460	770		Body frame thickness mm
Drawer 1	575	380	75	30	1.2 / 1.0
Drawer 2	575	380	75	30	Weight kg
Drawer 3	575	380	150	30	44
Base Storage	610	420	250		



-  **4 Drawer**
-  **4" Castor Wheels with Brakes**
-  **26" Wide Cabinet**
-  **3 Step Ball Bearing Slides**
-  **Heavy Gauge Steel**
-  **Comfort Grip Handle**
-  **5-Step Rust Protection**
-  **Combination Lock**

Item ID: **TCW804N**

### 26" PRO LOW HEIGHT CABINET 4 DRAWERS RED

- Three 75mm deep drawers and one 300mm deep drawer for storing large items
- Low height making it ideal for use beneath a low workbench
- Each drawer is suitable for holding 4 TengTools TC1 modules plus a TengTools TCX4 module
- Supplied with an ABS top mat and EVA drawer mats in each drawer
- Drawers have ball bearing slides for a smoother and more reliable opening and closing action
- Use with the tool modules from the TT Series or FOAM Series in the TengTools Tool Control system to build your ultimate tool kit

	Width mm	Depth mm	Height mm	Capacity kg	Drawer thickness mm
Cabinet	670	460	656		1
Cabinet + Wheels	670	460	770		Body frame thickness mm
Drawer 1	575	380	75	30	1.2 / 1.0
Drawer 2	575	380	75	30	Weight kg
Drawer 3	575	380	75	30	49
Drawer 4	575	380	300	30	

### 26" PRO LOW HEIGHT CABINET 6 DRAWERS RED

- Five 75mm deep drawers and one 150mm deep drawer for storing large items
- Low height making it ideal for use beneath a low workbench
- Each drawer is suitable for holding 4 TengTools TC1 modules plus a TengTools TCX4 module
- Supplied with an ABS top mat and EVA drawer mats in each drawer
- Drawers have ball bearing slides for a smoother and more reliable opening and closing action
- Use with the tool modules from the TT Series or FOAM Series in the TengTools Tool Control system to build your ultimate tool kit

	Width mm	Depth mm	Height mm	Capacity kg	Drawer thickness mm
Cabinet	670	460	656		1
Cabinet + Wheels	670	460	770		Body frame thickness mm
Drawer 1	575	380	75	30	1.2 / 1.0
Drawer 2	575	380	75	30	Weight kg
Drawer 3	575	380	75	30	54
Drawer 4	575	380	75	30	
Drawer 5	575	380	75	30	
Drawer 6	575	380	150	30	



- 6** Drawer
- 26"** Wide Cabinet
- Heavy Gauge Steel**
- 5-Step Rust Protection**
- 4"** Castor Wheels with Brakes
- 3 Step Ball Bearing Slides**
- Comfort Grip Handle**
- Combination Lock**

Item ID: **TCW806N**

### 26" PRO CABINET 6 DRAWERS RED

- Five 75mm deep drawers and one 300mm deep drawer for storing large items
- Each drawer is suitable for holding 4 TengTools TC1 modules plus a TengTools TCX4 module
- Supplied with an ABS top mat and EVA drawer mats in each drawer
- Drawers have ball bearing slides for a smoother and more reliable opening and closing action
- Use with the tool modules from the TT Series or FOAM Series in the TengTools Tool Control system to build your ultimate tool kit

	Width mm	Depth mm	Height mm	Capacity kg	Drawer thickness mm
Cabinet	670	460	813		1
Cabinet + Wheels	670	460	960		Body frame thickness mm
Drawer 1	575	380	75	30	1.2 / 1.0
Drawer 2	575	380	75	30	Weight kg
Drawer 3	575	380	75	30	59.6
Drawer 4	575	380	75	30	
Drawer 5	575	380	75	30	
Drawer 6	575	380	300	30	



- 6** Drawer
- 26"** Wide Cabinet
- Heavy Gauge Steel**
- 5-Step Rust Protection**
- 5"** Castor Wheels with Brakes
- 3 Step Ball Bearing Slides**
- Comfort Grip Handle**
- Combination Lock**

Item ID: **TCW806N1**



-  **7 Drawer**
-  **5" Castor Wheels with Brakes**
-  **26" Wide Cabinet**
-  **3 Step Ball Bearing Slides**
-  **Heavy Gauge Steel**
-  **Comfort Grip Handle**
-  **5-Step Rust Protection**
-  **Combination Lock**

Item ID: **TCW807N**

### 26" PRO CABINET 7 DRAWERS RED

- Five 75mm deep drawers and two 150mm deep drawers for storing large items
- Each drawer is suitable for holding 4 TengTools TC1 modules plus a TCX4 module
- Supplied with an ABS top mat and EVA drawer mats in each drawer
- Drawers have ball bearing slides for a smoother and more reliable opening and closing action
- Use with the tool modules from the TT Series or FOAM Series in the TengTools Tool Control system to build your ultimate tool kit

	Width mm	Depth mm	Height mm	Capacity kg	Drawer thickness mm
Cabinet	670	460	813		1
Cabinet + Wheels	670	460	960		Body frame thickness mm
Drawer 1	575	380	75	30	1.2 / 1.0
Drawer 2	575	380	75	30	Weight kg
Drawer 3	575	380	75	30	64
Drawer 4	575	380	75	30	
Drawer 5	575	380	75	30	
Drawer 6	575	380	150	30	
Drawer 7	575	380	150	30	



-  **7 Drawer**
-  **5" Castor Wheels with Brakes**
-  **26" Wide Cabinet**
-  **3 Step Ball Bearing Slides**
-  **Heavy Gauge Steel**
-  **Key Lock**
-  **5-Step Rust Protection**

Item ID: **TCW707EV**

### 26" STD CABINET 7 DRAWERS RED

- Five 75mm deep drawers and two 150mm deep for storing larger items
- Each drawer is suitable for holding 4 TengTools TC1 modules plus a TengTools TCX4 module
- Drawers have ball bearing slides for a smoother and more reliable opening and closing action
- Use with the tool modules from the TT Series or FOAM Series in the TengTools Tool Control system to build your ultimate tool kit

	Width mm	Depth mm	Height mm	Capacity kg	Drawer thickness mm
Cabinet	670	460	813		1
Cabinet + Wheels	670	460	960		Body frame thickness mm
Drawer 1	575	380	75	30	1.2 / 1.0
Drawer 2	575	380	75	30	Weight kg
Drawer 3	575	380	75	30	64
Drawer 4	575	380	75	30	
Drawer 5	575	380	75	30	
Drawer 6	575	380	150	30	
Drawer 7	575	380	150	30	

### 26" PRO CABINET 8 DRAWERS RED

- Seven 75mm deep drawers and one 150mm deep drawer for storing large items
- Each drawer is suitable for holding 4 TengTools TC1 modules plus a TengTools TCX4 module
- Supplied with an ABS top mat and EVA drawer mats in each drawer
- Drawers have ball bearing slides for a smoother and more reliable opening and closing action
- Use with the tool modules from the TT Series or FOAM Series in the TengTools Tool Control system to build your ultimate tool kit

	Width mm	Depth mm	Height mm	Capacity kg	Drawer thickness mm
Cabinet	670	460	813		1
Cabinet + Wheels	670	460	960		Body frame thickness mm
Drawer 1	575	380	75	30	1.2 / 1.0
Drawer 2	575	380	75	30	Weight kg
Drawer 3	575	380	75	30	61
Drawer 4	575	380	75	30	
Drawer 5	575	380	75	30	
Drawer 6	575	380	75	30	
Drawer 7	575	380	75	30	
Drawer 8	575	380	150	30	



- 8 Drawer**
- 5" Castor Wheels with Brakes**
- 26" Wide Cabinet**
- 3 Step Ball Bearing Slides**
- Heavy Gauge Steel**
- Comfort Grip Handle**
- 5-Step Rust Protection**
- Combination Lock**

Item ID: **TCW808N**

### 26" PRO CABINET 10 DRAWERS RED

- Six 50mm deep drawers, three 75mm deep drawers and one 150mm deep drawer for storing large items
- Each drawer is suitable for holding 4 TengTools TC1 modules plus a TengTools TCX4 module
- Supplied with an ABS top mat and EVA drawer mats in each drawer
- Drawers have ball bearing slides for a smoother and more reliable opening and closing action
- Use with the tool modules from the TT Series or FOAM Series in the TengTools Tool Control system to build your ultimate tool kit

	Width mm	Depth mm	Height mm	Capacity kg	Drawer thickness mm
Cabinet	670	460	813		1
Cabinet + Wheels	670	460	960		Body frame thickness mm
Drawer 1	575	380	50	30	1.2 / 1.0
Drawer 2	575	380	50	30	Weight kg
Drawer 3	575	380	50	30	69
Drawer 4	575	380	50	30	
Drawer 5	575	380	50	30	
Drawer 6	575	380	50	30	
Drawer 7	575	380	75	30	
Drawer 8	575	380	75	30	
Drawer 9	575	380	75	30	
Drawer 10	575	380	150	30	



- 10 Drawer**
- 5" Castor Wheels with Brakes**
- 26" Wide Cabinet**
- 3 Step Ball Bearing Slides**
- Heavy Gauge Steel**
- Comfort Grip Handle**
- 5-Step Rust Protection**
- Combination Lock**

Item ID: **TCW810N**





-  **10 Drawer**
-  **26" Wide Cabinet**
-  **Heavy Gauge Steel**
-  **5-Step Rust Protection**
-  **5" Castor Wheels with Brakes**
-  **3 Step Ball Bearing Slides**
-  **Comfort Grip Handle**
-  **Combination Lock**









Item ID: **TCW810NBK**

### 26" PRO CABINET 10 DRAWERS BLACK

- Six 50mm deep drawers, three 75mm deep drawers and one 150mm deep drawer for storing large items
- Each drawer are suitable for holding 4 TengTools TC1 modules plus 1 TCX4 module
- Supplied with an ABS top mat and EVA drawer mats in each drawer
- Drawers have ball bearing slides for a smoother and more reliable opening and closing action
- Use with the tool modules from the TT Series or FOAM Series in the TengTools Tool Control system to build your ultimate tool kit

	Width mm	Depth mm	Height mm	Capacity kg	Drawer thickness mm
Cabinet	670	460	813		1
Cabinet + Wheels	670	460	960		Body frame thickness mm
Drawer 1	575	380	50	30	1.2 / 1.0
Drawer 2	575	380	50	30	Weight kg
Drawer 3	575	380	50	30	69
Drawer 4	575	380	50	30	
Drawer 5	575	380	50	30	
Drawer 6	575	380	50	30	
Drawer 7	575	380	75	30	
Drawer 8	575	380	75	30	
Drawer 9	575	380	75	30	
Drawer 10	575	380	150	30	



-  **7 Drawer**
-  **26" Wide Cabinet**
-  **Heavy Gauge Steel**
-  **5-Step Rust Protection**
-  **5" Castor Wheels with Brakes**
-  **3 Step Ball Bearing Slides**
-  **Comfort Grip Handle**
-  **Combination Lock**
-  **Soft Close Drawers**

Item ID: **TCW907X**

### 26" PRO CABINET 7 SOFT CLOSE DRAWERS RED

- 7 full width soft close drawers
- Each drawer has an individual opening mechanism secured with a combination lock
- Five 75mm deep drawers and two 150mm deep drawers for storing large items
- Each drawer is suitable for holding 4 TengTools TC1 modules plus a TengTools TCX4 module
- Supplied with an ABS top mat and EVA drawer mats in each drawer
- Drawers have ball bearing slides for a smoother and more reliable opening and closing action
- Use with the tool modules from the TT Series or FOAM Series in the TengTools Tool Control system to build your ultimate tool kit

	Width mm	Depth mm	Height mm	Capacity kg	Drawer thickness mm
Cabinet	670	460	813		1
Cabinet + Wheels	670	460	960		Body frame thickness mm
Drawer 1	575	380	75	30	1.2 / 1.0
Drawer 2	575	380	75	30	Weight kg
Drawer 3	575	380	75	30	64
Drawer 4	575	380	75	30	
Drawer 5	575	380	75	30	
Drawer 6	575	380	150	30	
Drawer 7	575	380	150	30	

### 37" PRO CABINET 7 DRAWERS RED

- Five 75mm deep drawers and two 150mm deep for storing larger items
- Each drawer is suitable for holding 6 TengTools TC1 modules together with 1 TengTools TCX4 module and a TengTools TCX2 module
- Supplied with a rubber top mat, EVA drawer mats and plastic trimmed handles
- Drawers have ball bearing slides for a smoother and more reliable opening and closing action
- Use with the tool modules from the TT Series or FOAM Series in the TengTools Tool Control system to build your ultimate tool kit

	Width mm	Depth mm	Height mm	Capacity kg
Cabinet	953	460	813	
Cabinet + Wheels	953	460	960	
Drawer 1	860	380	75	25
Drawer 2	860	380	75	25
Drawer 3	860	380	75	25
Drawer 4	860	380	75	25
Drawer 5	860	380	75	25
Drawer 6	860	380	150	25
Drawer 7	860	380	150	25

Drawer thickness mm	1
Body frame thickness mm	1.0
Weight kg	78.6



- 7 Drawer
- 37" Wide Cabinet
- Heavy Gauge Steel
- 5-Step Rust Protection
- 5" Castor Wheels with Brakes
- 3 Step Ball Bearing Slides
- Comfort Grip Handle
- Combination Lock

Item ID: TCW207N

### 37" PRO CABINET 8 DRAWERS BLACK

- Seven 75mm deep drawers and one 150mm deep for storing larger items
- Each full width drawer is suitable for holding 4 TengTools TC1 modules together with a TCX4 module and a TCX2 module
- Supplied with a rubber top mat, EVA drawer mats and plastic trimmed handles
- Drawers have ball bearing slides for a smoother and more reliable opening and closing action
- Use with the tool modules from the TT Series or FOAM Series in the TengTools Tool Control system to build your ultimate tool kit

	Width mm	Depth mm	Height mm	Capacity kg
Cabinet	953	460	813	
Cabinet + Wheels	953	460	960	
Drawer 1	860	380	75	25
Drawer 2	860	380	75	25
Drawer 3	860	380	75	25
Drawer 4	860	380	75	25
Drawer 5	860	380	75	25
Drawer 6	860	380	75	25
Drawer 7	860	380	75	25
Drawer 8	860	380	150	25









Drawer thickness mm	1
Body frame thickness mm	1.0
Weight kg	81.3



- 8 Drawer
- 37" Wide Cabinet
- Heavy Gauge Steel
- 5-Step Rust Protection
- 5" Castor Wheels with Brakes
- 3 Step Ball Bearing Slides
- Comfort Grip Handle
- Combination Lock

Item ID: TCW208NBK1



-  **6 Drawer**
-  **3 Step Ball Bearing Slides**
-  **53" Wide Cabinet**
-  **Comfort Grip Handle**
-  **Heavy Gauge Steel**
-  **Combination Lock**
-  **5-Step Rust Protection**
-  **Single Drawer Opening**
-  **6" Castor Wheels with Brakes**









Item ID: **TCW806LN**

### 53" PRO CABINET 6 DRAWERS RED

- Three 65mm deep drawers, one 100mm deep and two 150mm deep drawers for storing large items
- Each drawer is suitable for holding 8 TengTools TC1 modules plus 2 TengTools TCX4 modules
- Supplied with an EVA mat in each drawer
- Drawers have ball bearing slides for a smoother and more reliable opening and closing action
- Supplied with a wooden top plate to create a hard wearing work surface
- Use with the tool modules from the TT Series or FOAM Series in the TengTools Tool Control system to build your ultimate tool kit

	Width mm	Depth mm	Height mm	Capacity kg	Drawer thickness mm
Cabinet	1350	460	767		1
Cabinet + Wheels	1350	460	937		Body frame thickness mm
Drawer 1	1215	380	65	40	1.2
Drawer 2	1215	380	65	40	Weight kg
Drawer 3	1215	380	65	40	144.5
Drawer 4	1215	380	100	40	
Drawer 5	1215	380	150	40	
Drawer 6	1215	380	150	40	



-  **9 Drawer**
-  **3 Step Ball Bearing Slides**
-  **53" Wide Cabinet**
-  **Comfort Grip Handle**
-  **Heavy Gauge Steel**
-  **Combination Lock**
-  **5-Step Rust Protection**
-  **6" Castor Wheels with Brakes**

Item ID: **TCW809N**

### 53" PRO CABINET 9 DRAWERS RED

- Six 75mm deep drawers, two 150mm deep and one 125mm deep full width drawer for storing large items
- Each regular width drawer is suitable for holding 4 TengTools TC1 modules plus a TengTools TTX4 module
- The full width drawer is suitable for holding 8 TengTools TC1 modules plus 2 TengTools TCX4 modules
- Supplied with an EVA mat in each drawer
- Drawers have ball bearing slides for a smoother and more reliable opening and closing action
- Supplied with a wooden top plate to create a hard wearing work surface
- Use with the tool modules from the TT Series or FOAM Series in the TengTools Tool Control system to build your ultimate tool kit

	Width mm	Depth mm	Height mm	Capacity kg	Drawer thickness mm
Cabinet	1350	460	767		1
Cabinet + Wheels	1350	460	937		Body frame thickness mm
Drawer 1	1215	380	125	40	1.2
Drawer 2	575	380	75	30	Weight kg
Drawer 3	575	380	75	30	152.5
Drawer 4	575	380	75	30	
Drawer 5	575	380	75	30	
Drawer 6	575	380	75	30	
Drawer 7	575	380	75	30	
Drawer 8	575	380	150	30	
Drawer 9	575	380	150	30	

### 67" PRO BEAST CABINET 13 DRAWERS RED

- A selection of 13 different size drawers to suit all sorts of storage
- Supplied with an EVA drawer mat for storing other tools and items
- Drawers have ball bearing slides for a smoother and more reliable opening and closing action
- An additional storage compartment fitted with a combination lock for storage of larger items
- Supplied with a wooden top plate to create a hard wearing work surface
- Use with the tool modules from the TT Series or FOAM Series in the TengTools Tool Control system to build your ultimate tool kit

	Width mm	Depth mm	Height mm	Capacity kg	Drawer thickness mm
Cabinet	1700	460	974		1
Cabinet + Wheels	1700	460	1153		Body frame thickness mm
Drawer 1	575	380	75	30	1.2
Drawer 2	575	380	75	30	Weight kg
Drawer 3	575	380	75	30	195.8
Drawer 4	575	380	75	30	
Drawer 5	575	380	75	30	
Drawer 6	575	380	154	30	
Drawer 7	575	380	312	30	
Drawer 8	288	380	75	30	
Drawer 9	288	380	75	30	
Drawer 10	288	380	75	30	
Drawer 11	288	380	154	30	
Drawer 12	288	380	154	30	
Drawer 13	1567	380	120	40	



-  **13 Drawer**
-  **6" Castor Wheels with Brakes**
-  **67" Wide Cabinet**
-  **3 Step Ball Bearing Slides**
-  **Heavy Gauge Steel**
-  **Comfort Grip Handle**
-  **5-Step Rust Protection**
-  **Combination Lock**

Item ID: **TCW814N**



### SIDE CUPBOARD RED

- Designed to fit on the side of a TengTools cabinet to create additional storage
- Fully lockable with a key lock
- Fitted shelf included making it ideal for storing aerosols and bulkier items



- Heavy Gauge Steel**
- 5-Step Rust Protection**
- Key Lock**

Item ID: **TCW-CAB**

### PRO SIDE CABINET 1 DRAWER RED

- Designed to fit on the side of a TengTools cabinet to create additional storage
- Fully lockable with a combination lock
- When mounting to a cabinet with a back panel fitted a side plate (Item ID: TCW-SP01) must be used to install



- Heavy Gauge Steel**
- 5-Step Rust Protection**
- Combination Lock**

Item ID: **TCW-CAB02**

### PRO SIDE CABINET 7 DRAWERS RED

- Designed to fit on the side of a TengTools cabinet to create additional storage
- Fully lockable with a combination lock
- Five 75mm deep drawers and two 150mm deep drawers for storing large items
- When mounting to a cabinet with a back panel fitted a side plate (Item ID: TCW-SP01) must be used to install



- 7 Drawer**
- Heavy Gauge Steel**
- 5-Step Rust Protection**
- 3 Step Ball Bearing Slides**
- Combination Lock**

	Width mm	Depth mm	Height mm	Capacity kg
Overall	382	460	795	
Drawer 1	288	380	75	30
Drawer 2	288	380	75	30
Drawer 3	288	380	75	30
Drawer 4	288	380	75	30
Drawer 5	288	380	75	30
Drawer 6	288	380	150	30
Drawer 7	288	380	150	30

Item ID: **TCW-CAB01**

### PRO SIDE CABINET WITH DOOR RED

- Designed to fit on the side of a TengTools cabinet to create additional storage
- Fully lockable with a combination lock
- When mounting to a cabinet with a back panel fitted a side plate (Item ID: TCW-SP01) must be used to install



- Heavy Gauge Steel**
- 5-Step Rust Protection**
- Combination Lock**

Item ID: **TCW-CAB03**



\*Tools not included

### TC4 CARRYING CASE

- An empty carrying case for use with 4 TengTools TC1 modules
- The ideal way to create an individual, fully portable tool set
- Click lock and integral carrying handle
- Supplied with shoulder straps to use as a back pack
- The underside of the case is fitted with rubber feet to stop it sliding

ITEM ID:	Description
TC-4	Portable carrying case
TC-4SBL	Spare straps



### MECCA PRO TC6 SERVICE CASE

- Service case for use with up to 6 TengTools TC1 modules.
- Hard wearing carrying case with distinctive branding.
- Robust moulded body with built in strength and durability.
- Handle on side make it easy to carry.

Item ID: **TC-6T**

### MECCA PRO™



### MECCA PRO TC9 SERVICE CASE

- Space for up to 9 TengTools TC1 modules
- Hard wearing flight case style carrying case with a combination lock and secure catches
- Robust moulded body with built in strength and durability
- Complete with fixed castor wheels and retractable handle for easy carrying
- Handles on the end and side make it easy to carry
- Non slip rubber feet to prevent the case from sliding about
- Combination lock and snap tight catches keep the tools secure
- Designed to hold 3 TengTools TC1 modules in each of three compartments

Item ID: **TC-SC**



### MINI TOP BOX

- Drop front with the TengTools logo to cover the drawers when the box is closed
- Drawers have ball bearing slides for a smoother and more reliable opening and closing action
- The underside of the box is fitted with rubber feet to prevent it from sliding
- Manufactured from heavy gauge top quality steel for rigidity and durability
- Powder coated with a 5 step rust prevention and undercoat to help prevent corrosion

	Width mm	Depth mm	Height mm	Capacity Kg	Weight kg
Overall	275	150	150		2.9
Drawer 1	215	130	38	5	
Drawer 2	215	130	38	5	

Item ID: **TC103NF**





**PLASTIC TOOL BOX**

- Plastic carrying case, ideal for carrying and storing tools
- Includes a tray with dividers for storing smaller items
- Double snap lock mechanism for a secure fit when closing the box

Item ID: **TCP445C**

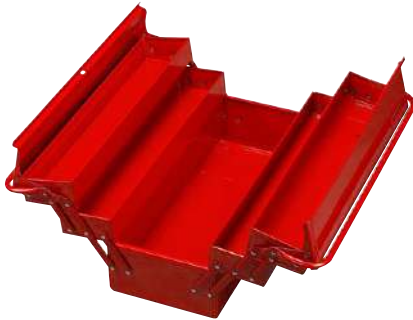

**CANTILEVER TOOL BOX**

- A professional quality box with 5 individual storage areas
- Carrying handle designed to fold to the sides to enable easy access to the tools
- Padlock facility and full length piano hinges with turned edges for added safety

ITEM ID:	Description
TC540	Cantilever Tool Box
TC-540W	4x wheels for the cantilever tool box



**BARN STYLE TOOL BOX**

- Complete with aluminium clip rails for storing sockets
- 30 each of 1/4", 3/8" and 1/2" drive socket clips included
- A lift out tool tray and tool storage areas provide extra space
- Carrying handle designed to fold to one side to enable easy access
- Padlock facility and full length piano hinges with turned edges for added safety

Item ID: **TC450**



**BACK PACK TOOL BOX**

- Specifically designed for carrying tools
- Use the shoulder straps as a back pack or the carrying handles as a carrying bag
- Manufactured in polyester with EVA plastic base for durability
- Includes various external pockets for small tools

Item ID: **TCSB**



**TOOL BAG**

- Specifically designed for carrying tools
- Compartment that holds up to 3 TengTools TC1 modules
- Use the shoulder strap or the robust aluminium carrying handle with an ergonomic grip
- Includes various pockets and holders for storing tools

Item ID: **TCSB16**



**TOP BOX COVER RED**

- Protective cover with the TengTools logo
- Fits TengTools 26" top boxes

Item ID: **TC-COVER**



**CABINET COVER RED**

- Protective cover with the TengTools logo
- Fits TengTools 26" roller cabinets

Item ID: **TC-WC02**



**STACK COVER RED**

- Protective cover with the TengTools logo
- Fits TengTools 26" stacks

Item ID: **TC-COVER1**



**NON SLIP MAT ROLL**

- Rubber mat for placing in tool boxes or tool box drawers
- 2mm thick to protect the tool box paint work
- Can also be used on work surface areas such as cabinet tops and work tops
- Resistant to oil and grease making it ideal for most workshops
- Simply cut to the required shape and size
- Supplied as a 2 meter x 45cm roll

Item ID: **TC-MAT**







**ABS TOP FOR 26" CABINET**

- ABS tray designed to fit the top of TengTools standard width (26"/660mm) cabinets
- Individual parts areas plus positioning for a middle box or top box to give a very organised work area
- Protects the top of the roller cabinet from scratches and marks

Item ID: **ABS-TOP**



**TOTE TRAY**

- Plastic tray with an aluminium handle for lighter weight
- Fitted with rubber feet on the base for less risk of scratching
- Rubber mat included to stop tools sliding around when being carried
- Helps keep tools and components close to hand and organised

Item ID: **TCA05**

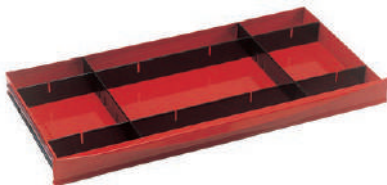

**DIVIDER SET SMALL**

- Interlocking black metal dividers for use in top box size drawers
- A simple way to create a drawer with 9 separate compartments

Item ID: **TCDIVS**



**MIDDLE BOX FIXING BRACKETS**

- Designed to secure a TengTools middle box to a TengTools cabinet
- Simply bolts to the middle box and clips on to the roller cabinet lip
- Prevents the middle box from tipping when moving the stack system

Item ID: **TCF01**



**TOP BOX FIXING BRACKETS**

- Designed to secure a TengTools middle box to a TengTools cabinet
- Simply bolts to the middle box and clips on to the roller cabinet lip
- Prevents the middle box from tipping when moving the stack system

ITEM ID:	Suitable for	No. of Pieces
TCF02	26" wide top box	2
TCF04	37" wide top box	2
TCF03	53" wide top box	2



**DIVIDER SET LARGE**

- Interlocking black metal dividers for use in roller cabinet size drawers
- A simple way to create a drawer with 9 separate compartments

Item ID: **TCDIVL**



**MAGNETIC TRAY RED**

- Creates extra storage quickly and easily with no drilling required
- Can be easily fitted to any flat ferrous material surface
- Powerful magnets for secure fixing
- Ideal for using on the side of a tool cabinet

ITEM ID:	Width mm	Depth mm	Height mm	No. of magnets	Weight g
580K	230	98	136	2	625
580M	460	98	136	4	1164
580N	640	98	136	6	1707



**MAGNETIC TRAY FOR CANS RED**

- Magnetic side shelf for storing bottles and cans
- Creates extra storage quickly and easily with no drilling required
- Can be easily fitted to any flat ferrous material surface
- Powerful magnets for secure fixing
- Ideal for using on the side of a tool cabinet

ITEM ID:	Width mm	Depth mm	Height mm	No. of Can Holders	Weight g
580CK	230	98	136	2	625
580CM	460	98	136	4	1200
580CN	640	98	136	6	1683

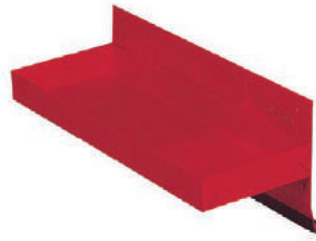

**MAGNETIC TRAY FOR CANS RED**

- Magnetic side shelf for storing bottles and cans
- Creates extra storage quickly and easily with no drilling required
- Can be easily fitted to any flat ferrous material surface
- Powerful magnets for secure fixing
- Ideal for using on the side of a tool cabinet

ITEM ID:	Width mm	Depth mm	Height mm
580C	310	115	31
580D	210	115	31



**MAGNETIC SIDE SHELF RED**

- Creates extra storage quickly and easily with no drilling required
- Can be easily fitted to any flat ferrous material surface
- Powerful magnets for secure fixing
- Ideal for using on the side of a roller cabinet

ITEM ID:	Width mm	Depth mm	Height mm
580J	410	90	100



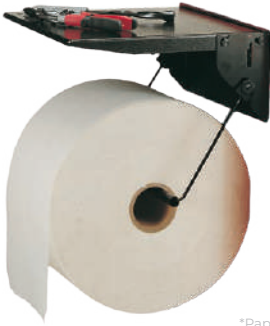

\*Paper roll not included

### PAPER ROLL HOLDER

- Designed to fit on to the side of TengTools cabinets (fixings included)
- Fold out side tray (370 x 370mm) to create an additional working area
- Fixing bar for paper rolls up to 360mm width (paper roll not included)

Item ID: **TCA01**



### SIDE SHELF FOR VICE

- Designed to fit on to the side of TengTools cabinets (fixings included)
- Side shelf has fixing holes for the TengTools 4" work bench vice

Item ID: **TCATV**



### 4" WORK BENCH VICE

- Forged steel 4" (100mm)
- Interchangeable parallel jaws and removable V shaped jaws for holding pipes and tubes
- High wear resistance with S455 steel (HRC45-50 hardness) for durability and strength
- Maximum clamping force of 300kg/cm<sup>2</sup> to grip most items tightly

Item ID: **TCAV4**



### SIDE PANEL FOR CABINET

- Designed to fit on the side of a TengTools regular height tool cabinet
- Creates an additional storage area for hanging tools or adding hook in accessories
- Dimensions: 805(H)x456(W)x25(D)mm

Item ID: **TCW-SP01**



\*Hooks not included

### SIDE PANEL WITH STAND

- Designed to fit on the side of a TengTools regular height tool cabinet
- Creates an additional storage area for hanging tools or adding hook in accessories
- Supplied with a carrying handle and a fold out leg to create a free standing tool storage unit
- Dimensions: 460x640mm

Item ID: **TCW-SP**



### TOOL HOOKS

- Hooks for use with TengTools panels with square holes
- Screw fixing to fix the hook securely in place
- Ideal for hanging tools on a work station panel or a side plate on a roller cabinet

ITEM ID:	Description
TCW-HK10	7 x 90°, 3 x 45° hooks
TCW-HK02	10 double hooks
TCW-HK45	10 45° hooks for TCW-SP side plate
TCW-HK90	10 90° hooks for TCW-SP side plate
TCW-HKAIR	10 x Air Tool Hooks



### SOCKET CLIP RAIL SET

- Four track aluminium section together with carrying handles
- 450mm overall length to fit in most tool boxes
- Supplied with 10 each socket clips in 1/4", 3/8" and 1/2" drive

Item ID: **ALU450**



### SOCKET CLIP RAILS

- Aluminium section for mounting on the wall or in a tool box
- For use with TengTools socket clips in 1/4", 3/8", 1/2", or 3/4"

ITEM ID:	Description
ALU430	430mm single track socket rail
ALU1000-1	1 metre single track socket rail
ALU1000-4	1 metre four track socket rail



### SOCKET SLIPS

- Packs of 10
- For storing sockets and accessories on clip rails

ITEM ID:	Description
ALU14	10 x 1/4" drive socket clips
ALU38	10 x 3/8" drive socket clips
ALU12	10 x 1/2" drive socket clips
ALU34	10 x 3/4" drive socket clips



### MAGNETIC TOOL RAIL

- 6 individual magnets each with a capacity of 450g
- Designed to fix to the side of TengTools roller cabinets
- Also suitable for wall mounting or for use with other tool boxes
- Ideal for hanging up tools while working

Item ID: **TC-MAG**



### WORKTOPS FOR TOOL CABINETS

- 37mm thick worktops in hard wearing laminated wood
- Three sizes available to suit different roller cabinets

ITEM ID:	Length mm	Depth mm	Thickness mm	Suitable for
TC-TB02	672	460	37	TCW803N, TCW804N, TCW806N, TCW806N1, TCW807N, TCW808N, TCW810N, TCW-707EV, TCW907X
TC-TB03	948	460	18	TCW207N, TCW208NBK1
TC-TB01	1354	460	37	TCW806LN, TCW809N





**SIDE HANDLES FOR TOP/MIDDLE BOX**

- A pair of side handles with soft grip for use with TengTools top boxes and middle boxes

Item ID: **TCDSH**



**SIDE HANDLE FOR CABINET**

- Side handle for TengTools roller cabinets
- The soft grip handle gives improved comfort

Item ID: **TCRFH**



**WHEEL SET 4" X 1-1/4" - 2 PIECES**

- A set of two 4" (100mm) casters
- Two swivel wheels in a set

Item ID: **TCW-SW**



**WHEEL SET 5" X 2" - 4 PIECES**

- A set of four 5" (125mm) black castors with needle bearings
- 2" wide wheels give extra strength and stability
- Capacity of 170 kilos per castor or 500 kilos for the set of four
- Ideal for upgrading a TengTools roller cabinet for heavier use
- Two fixed and two swivel wheels with 2 stage brakes in the set

Item ID: **TCNBC**



**WHEEL SET 6" X 2" - 4 PIECES**

- A set of four 6" (150mm) black castors with needle bearings
- 2" wide wheels give extra strength and stability
- Capacity of 250 kilos per castors or 750 kilos for the set of four.
- Two fixed and two swivel wheels with brakes in the set

Item ID: **TCWIQ-SC**



**TROLLEY FOR TOP BOX**

- Frame with a set of 4 wheels for TengTools regular top boxes
- Creates a mobile tool box
- Especially useful if the tool box is heavily laden with tools

Item ID: **TCTMC**



**TROLLEY FOR SIDE CABINET**

- Frame with a set of 4 wheels for TengTools side cabinets
- Creates a mobile tool box or storage unit
- Especially useful if the cabinet is heavily laden

Item ID: **TCSMC**





### ONE KEY THREE LOCKS

- Set of 3 key type locks for TengTools tool boxes
- One common key number
- Enables a stack system to be converted to have one common key on all locks

Item ID: **TC-LOCK3**

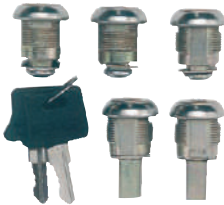

### ONE KEY FIVE LOCKS

- Set of 5 key type locks for TengTools tool boxes
- One common key number
- Enables a stack system to be converted to have one common key on all locks

Item ID: **TC-LOCK5**



### BLANK KEY

- Set of 3 key type locks for TengTools tool boxes
- One common key number
- Enables a stack system to be converted to have one common key on all locks

Item ID: **TC-BKEY**

## REPLACEMENT LOCKS

Which lock to choose?



### Key Locks

ITEM ID:

TCDRK

TCPRK

Tool Box	Description	Lock
TC806SV	6 drawer top box	TCPRK
TC803SV	3 drawer middle box	TCDRK
TCW707EV	7 drawer roller cabinet	TCDRK
TCW-CAB	Side cupboard	TCPRK



### Combination Locks





ITEM ID:

TC-90CLOCK

TC-180CLOCK

Tool Box	Description	Lock
TC805NFX	5 drawer top box	TC-90CLOCK
TC806NF	6 drawer top box	TC-90CLOCK
TC806NGM	6 drawer top box	TC-90CLOCK
TC803N	3 drawer middle box	TC-180CLOCK
TC803NBK	3 drawer middle box	TC-180CLOCK
TCW803N	3 drawer roller cabinet	TC-180CLOCK
TCW803N	Storage compartment	TC-90CLOCK
TCW804N	4 drawer roller cabinet	TC-180CLOCK
TCW806N	6 drawer roller cabinet	TC-180CLOCK
TCW806N1	6 drawer roller cabinet	TC-180CLOCK
TCW807N	7 drawer roller cabinet	TC-180CLOCK
TCW810N	10 drawer roller cabinet	TC-180CLOCK
TCW810NBK	10 drawer roller cabinet	TC-180CLOCK
TC810N	10 drawer double width top box	TC-90CLOCK
TCW207N	7 drawer 37" wide roller cabinet	TC-180CLOCK
TCW208NBK1	8 drawer 37" wide roller cabinet	TC-180CLOCK
TCW806LN	6 drawer double width roller cabinet	TC-180CLOCK
TCW809N	9 drawer double width roller cabinet	TC-180CLOCK
TCW-CAB01	Side cabinet	TC-180CLOCK
TCW-CAB02	Side cabinet	TC-180CLOCK
TCW-CAB03	Side cabinet	TC-90CLOCK



-  **Heavy Gauge Steel**
-  **5-Step Rust Protection**
-  **5" Castor Wheels with Brakes**
-  **3 Step Ball Bearing Slides**

### 26" TOOL TROLLEY 1 DRAWER RED

- Mobile trolley
- A mobile work trolley with shelves and a drawer
- Two fixed castors and two swivelling castors with brakes
- Two shelves and a ball bearing slide drawer
- Ideal for moving parts and equipment around the work place

ITEM ID	Height mm	Height (Wheels) mm	Width mm	Depth mm
TR070	770	932	700	450



### WORK BENCHES

- Sturdy, laminated granite effect work surface with black edging
- Adjustable legs to give a working height of between 707 & 927mm

ITEM ID	Length mm	Depth mm	Weight kg
TWB1500	1500	800	53
TWB2000	2000	800	69

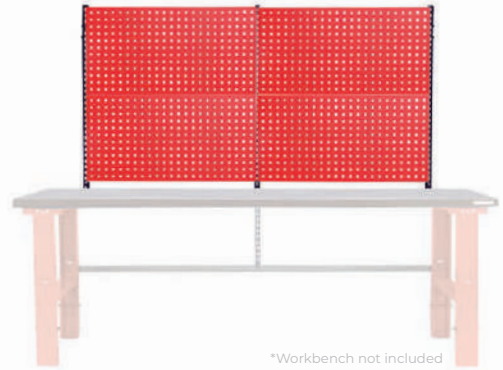

### WORK BENCH TOOL PANEL KITS

- A panel kit complete with uprights and fixings for use with the TengTools workbench
- Converts a workbench into a work station
- Uses the TengTools square hole system for use with a wide range of hooks and accessories

ITEM ID	Suitable for	Width mm	No. of Panels
TWB-1500A	TWB1500	1500	2
TWB-2000A	TWB2000	2000	4

### WORKBENCH SPARE PARTS

ITEM ID:	Description
TWB-1STOP	Workbench Work Top 1500mm
TWB-20TOP	Workbench Work Top 2000mm
TWB-4WD	Workbench Wheel Set
TWB-LEG	Workbench Legs 2 Pieces
TWB-PA	Workbench Panel
TWB-UPR	Workbench Upright
TWB-15SQ	Workbench Spare 9 Hole Square Tube





WORKBENCH ADD-ONS FOR CABINETS



\*Tool Cabinet not included

**TOOL PANEL SET FOR 26" CABINET**

- Preconfigured pack including panels, uprights, fixing bars, a header and a work top
- Designed to fit on top of TengTools cabinets
- Creates a single width work station

ITEM ID	Suitable for
TC-S01	26" Tool Cabinets
TC-SL01	53" Tool Cabinets



\*Tool Cabinets not included

**ADD ON PANEL SET BETWEEN CABINETS**

- Preconfigured pack including panels, brackets, fixing bars, a header and a work top
- Designed to fit with a TengTools cabinet when a panel set has already been installed
- Creates a double width work station

ITEM ID	Suitable for
TC-S02	26" Tool Cabinets
TC-SL02	53" Tool Cabinets



### ADD ON PANEL SET BESIDE CABINET

- Preconfigured pack including panels, brackets, fixing bars, a header, a work top and a side leg
- Designed to fit with a TengTools cabinet when a panel set has already been installed
- Creates a double width work station

ITEM ID	Suitable for	Side
TC-S03AL	26" Tool Cabinets	Left Add-on
TC-SL03AL	53" Tool Cabinets	Left Add-on
TC-S03AR	26" Tool Cabinets	Right Add-on
TC-SL03AR	53" Tool Cabinets	Right Add-on



- Heavy Gauge Steel**
- 5-Step Rust Protection**
- Combination Lock**

### TOOL CABINETS WITH PEG HOLES

- Panels have square peg holes for use with the range of TengTools hooks
- Ideal for use with workbenches or on top of any standard width TengTools roller cabinet

ITEM ID	Width mm	Height mm	Depth mm	Weight kg
TCB80	660	600	305	15
TCB80A	660	600	455	16.5



-  **Heavy Gauge Steel**
-  **5-Step Rust Protection**
-  **Combination Lock**

### WALL HANGING TOOL CABINET 1350 mm

- Inside panel has square peg holes for use with the range of TengTools hooks
- Designed for wall mounting, heavy duty mounting brackets included
- Ideal for use with workbenches to create a self contained working area

ITEM ID	Width mm	Height mm	Depth mm	Weight kg
TCB135	1335	700	200	35.75



-  **Heavy Gauge Steel**
-  **5-Step Rust Protection**
-  **Combination Lock**

### WALL HANGING TOOL CABINET 1800 mm

- Inside panel has square peg holes for use with the range of TengTools hooks
- Designed for wall mounting, heavy duty mounting brackets included
- Ideal for use with workbenches to create a self contained working area

ITEM ID	Width mm	Height mm	Depth mm	Weight kg
TCB180	1800	700	200	50

## WORKSTATION SPARE PARTS

ITEM ID:	Description
TC-LBK	L Brackets 2pcs
TC-LEG	Support Leg
TC-FB01	664mm Fixing Bar
TC-FB02	1353mm Fixing Bar
TC-H01	670mm Header
TC-H02	1380mm Header
TC-PA01	Panel for 26" cabinets
TC-PA02	Panel for 53" cabinets
TC-UPRL	Left Upright Long
TC-UPRR	Right Upright Long
TC-160UR	Uprights 1.6m 2pcs
TC-FB03	916mm Fixing Bar
TC-PA03	Panel for 37" cabinets
TC-H05	950mm Header
TC-UPRLS	LHS Upright Short
TC-UPRRS	RHS Upright Short
TWB-20SQ	7 Hole Square Tube
TC-H03	1.5m Header
TC-H04	0.5m Header
TWB-FB	Fixing Bar 875mm



### HOOK ON TRAY

- Parts tray for tool panels
- Designed to hook in to the square holes on panels
- Ideal for storing accessories, components, small tools, etc.

ITEM ID	Width mm	Depth mm	Height mm
TCT01	230	101	139
TCT02	460	101	140
TCT03	640	103	141



### HOOK ON TRAY FOR CANS

- Aerosol can holder for tool panels
- Designed to hook in to the square holes on TengTools panels
- Ideal for storing aerosol cans, bottles, etc.

ITEM ID	Width mm	Depth mm	Height mm	No. of Can Holders
TCC01	230	98	136	2
TCC02	460	99	137	4
TCC03	640	100	138	6



### TOOL HOOKS

- Hooks for use with TengTools panels with square holes
- Screw fixing to fix the hook securely in place
- Ideal for hanging tools on a work station panel or a side plate on a roller cabinet

ITEM ID:	Description
TCW-HK10	7 x 90°, 3 x 45° hooks
TCW-HK02	10 double hooks
TCW-HK45	10 45° hooks for TCW-SP side plate
TCW-HK90	10 90° hooks for TCW-SP side plate
TCW-HKAIR	10 x Air Tool Hooks



\*T-bar not included

### HOOK ON TOOL HOLDER

- Hook tool holder for tool panels
- Designed to hook in to the square holes on TengTools wall and side panels and wall cabinets
- Ideal for storing tools such as T bars etc

Item ID: **TCT04**



### MAGNETIC LED LIGHT BAR

- 255mm wide light bar with 9 built in white LED lights
- 120 light distribution angle to illuminate a wide area
- Magnetic attachment for fixing quickly and simply with no drilling required
- Requires 3 AA batteries (not included)
- Ideal for use with workbenches as a light source

Length mm	Width mm	Height mm	Light Lumen	Magnetic Pull N	Weight g
255	40	29	20	30 x2	188

Item ID: **587J**

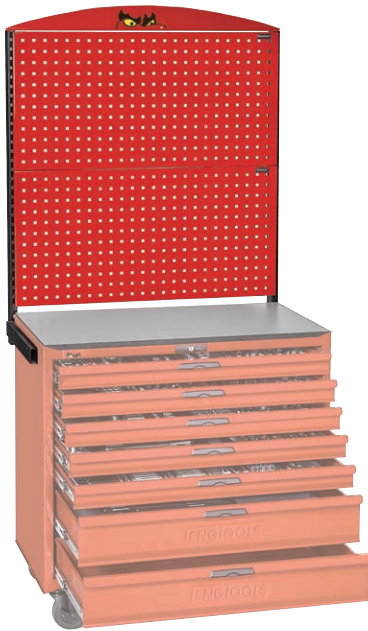

\*Tool Cabinet not included

- Heavy Gauge Steel
- 5-Step Rust Protection

**ADD ON PANEL SET FOR 37" CABINET**

- Preconfigured pack including panels, fixing bar, a header and uprights
- Designed to fit on top of an extra wide 37" TengTools roller cabinet
- Creates an extra wide single width work station with a high level back panel

ITEM ID	Suitable for	Number of Panels
TC-S03	37" Roller Cabinet	2
TC-S04	37" Roller Cabinet	1

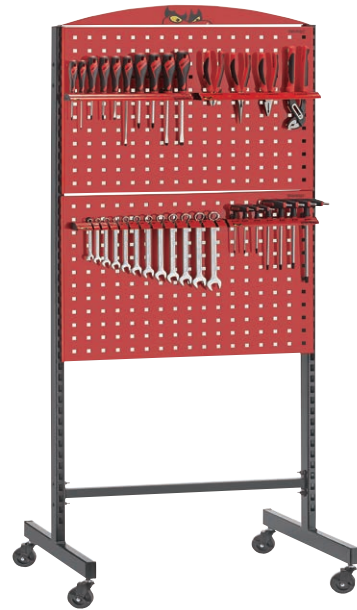

- Heavy Gauge Steel
- 5-Step Rust Protection

**33**  
Pieces

**PORTABLE TOOL PANEL TOOL KIT 33 PIECES**

- Mobile work station with tools
- A single sided portable work station (TPM01) supplied with tools
- Includes four wall rack sets covering screwdrivers, pliers, spanners and T handle hex keys
- The ideal movable tool station for use around the work place

Contents	
Item ID	Description
WRMD10N	Screwdriver Set Wall Rack 10 Pieces
WRMB04	Plier Set Wall Rack 4 Pieces
WRSP12	Combination Spanner Set 8-19 mm Wall Rack 12 Pieces
WRHEX07	T-Handle Ball Point Hex Key Set Wall Rack 7 Pieces

Item ID: **TPT01**



 **Heavy Gauge Steel**

 **5-Step Rust Protection**

#### PORTABLE TOOL PANELS

- The ideal way to store tools when they need to be moved around the work place
- The unit is 1.6m tall on castors
- Tool panels can be fitted to either side
- For use with TengTools wall racks and workbench accessories

ITEM ID	Front Panels	Back Panels
TPM01	2	0
TPM02	2	2

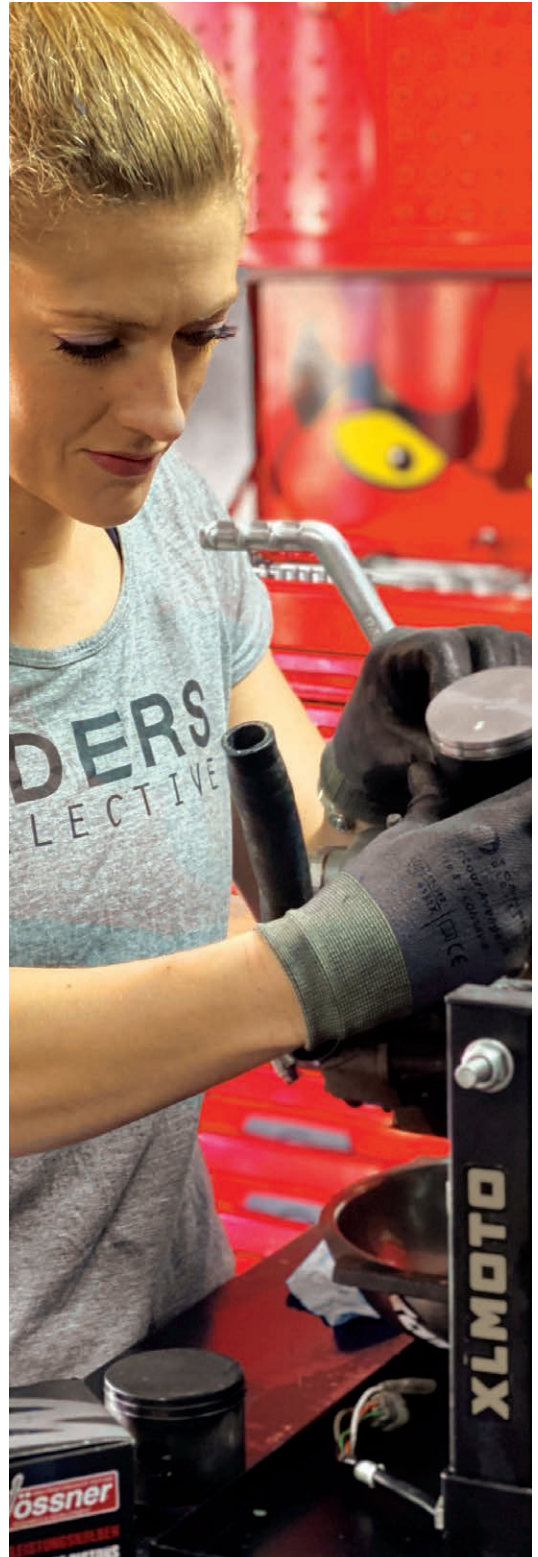

# SOCKET SETS

## Always ready for action









Tengtools socket sets are designed with a focus on quality, durability, and accessibility. We use high-grade materials such as chrome vanadium steel for sockets, and offer a wide range of sizes in both metric and AF measurements.

The sockets are clearly marked and easy to identify, and the sets are compatible with different types of ratchets and extensions.

## MECCA PRO™

### SOCKET SETS

IN DURABLE, SHOCKPROOF CASES

-  Secure lock system with click mechanism so you know the top is closed properly
-  Hard-wearing hinge with metal pin for increased life
-  Retractable handle, especially designed for comfort and durability.
-  Clear layout makes it easier to see which tools are missing
-  Rubber feet to prevent the box from sliding and which protects against scratching
-  Fully recyclable packaging that helps the environment

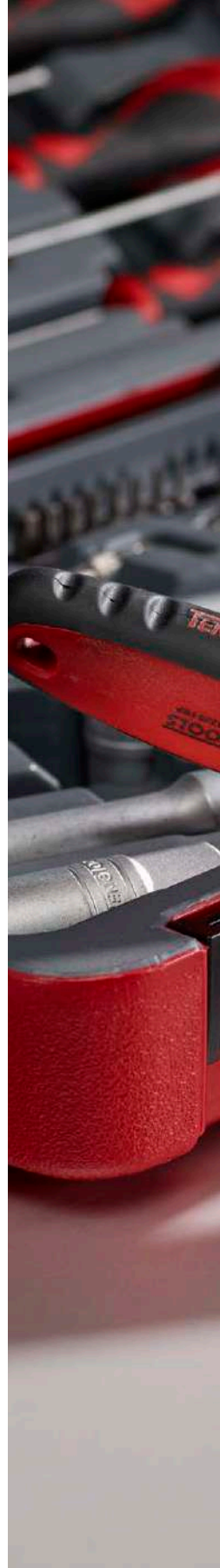

Get Organised™





**1/4" DRIVE**



**1/4" SOCKET SET 6 PT 13 PIECES**

- A basic no nonsense set of 1/4" drive sockets
- Chrome vanadium
- Satin finish for a better grip when handling the socket
- 6 point single hexagon sockets for a better fit
- Ball bearing recess on the female end to grip the ratchet or power bar
- Designed and manufactured to DIN and ISO standards
- Supplied in a handy pocket sized holder with a clip rail facility for adding additional sockets or accessories

Flip Reverse Ratchet	
2" Extension Bar	
Regular 6 point sockets:	
mm:	4 5 5.5 6 7 8
	9 10 11 12 13

Item ID: **M1413N1**



**TT SERIES** Socket Sets available

**MODULAR TOOL CONTROL SYSTEM**

**PAGE 55**



**1/4" SOCKET SET 6 PT WITH BELT CLIP**

- Socket set that fits into the TTTJ04 module allowing you to store 4 TJ sets in a single module
- 1/4" drive stubby ratchet and accessories
- 1/4" drive sockets and a selection of bits

Stubby 72 teeth ratchet, 2" extension bar, 1/4" M x 1/4" Hex adaptor	
Regular 6 point sockets:	
mm:	5.5 6 7 8 10 12 13
1/4" Hex bits:	5.5 4, 5 PH1, PH2
Length 25mm	

Item ID: **TJ1415**



**1/4" SOCKET SET 6 PT WITH BELT CLIP**

- Socket set that fits into the TTTJ04 module allowing you to store 4 TJ sets in a single module
- 1/4" drive bits ratchet and accessories
- 1/4" drive sockets and a selection of bits

1/4" bits ratchet, 50mm magnetic bits holder, 1/4" M x 1/4" Hex adaptor	
Regular 6 point sockets:	
mm:	8 9 10 11 12 13
1/4" Hex bits:	4.5, 5.5, 6.5 PH1, PH2
Length 25mm	PZ1, PZ2 4, 5, 6

Item ID: **TJ1419**



### 1/4" SOCKET SET 6 PT WITH BELT CLIP

- Socket set that fits into the TTTJ04 module allowing you to store 4 TJ sets in a single module
- 1/4" drive bits ratchet and accessories
- 1/4" drive sockets and a selection of bits

1/4" bits ratchet, 50mm magnetic bits holder, 1/4"M x 1/4" Hex adaptor

Regular 6 point sockets:

mm:	5.5	6	7	8	9	10	13
1/4" Hex bits:	+	4.5, 5.5, 6.5	+	PH1, PH2			
Length 25mm	+	PZ1, PZ2	+	TX10, TX15, TX20			

Item ID: **TJ1420**



### 1/4" SOCKET SET 6 PT 8 PIECES

- Regular 6 point single hexagon sockets for a better grip
- Chrome vanadium satin finish sockets
- Supplied in the unique TengTools case with a snap lock
- Hard wearing hinge with a metal pin for longer life
- Designed and manufactured to DIN and ISO standards

Stubby 72 teeth ratchet

Regular 6 point sockets:

mm:	5.5	6	7	8	10	12	13
-----	-----	---	---	---	----	----	----

Item ID: **T1408**



### 1/4" SOCKET SET 6 PT 19 PIECES

- Regular 6 point single hexagon sockets for a better grip
- Chrome vanadium satin finish sockets
- A selection of screwdriver and hex bits
- Supplied in the unique TengTools case with a snap lock
- Hard wearing hinge with a metal pin for longer life
- Designed and manufactured to DIN and ISO standards

1/4" Mini bits ratchet

Magnetic bits holder, 1/4"M x 1/4" Hex adaptor

Regular 6 point sockets:

mm:	8	9	10	11	12	13
1/4" Hex bits:	+	4.5, 5.5, 6.5	+	4, 5, 6		
	+	PH1, PH2	+	PZ1, PZ2		

Item ID: **T1419**



**FOAM SERIES**

Socket Sets available

**MODULAR TOOL CONTROL SYSTEM**



**PAGE 122**



20 Pieces 1/4" mm

**1/4" SOCKET SET 6 PT 20 PIECES**

- Regular 6 point single hexagon sockets for a better grip
- Chrome vanadium satin finish sockets
- A selection of screwdriver and TX bits
- Supplied in the unique TengTools case with a snap lock
- Hard wearing hinge with a metal pin for longer life
- Designed and manufactured to DIN and ISO standards

1/4" Mini bits ratchet						
Magnetic bits holder, 1/4"M x 1/4" Hex adaptor						
Regular 6 point sockets:						
mm:	5.5	6	7	8	9	10 13
1/4" Hex bits:	⊖ 4, 5.5, 6.5	⊕ TX10, TX15, TX20				
	⊕ PH1, PH2	⊕ PZ1, PZ2				

Item ID: **T1420**



23 Pieces 1/4" mm

**1/4" SOCKET SET 6 PT 23 PIECES**

- Regular 6 point single hexagon sockets for a better grip
- Chrome vanadium satin finish sockets
- A 4" adjustable wrench and a selection of bits
- Supplied in the unique TengTools case with a snap lock
- Hard wearing hinge with a metal pin for longer life
- Designed and manufactured to DIN and ISO standards

1/4" Mini bits ratchet						
4" Adjustable wrench, 1/4"M x 1/4" Hex adaptor, 2" Extension bar						
Regular 6 point sockets:						
mm:	4	5	5.5	6	7	8 10 12 13
1/4" Hex bits:	⊖ 4, 5.5, 6.5	⊕ TX10, TX15, TX20				
	⊕ PH1, PH2	⊕ PZ1, PZ2				

Item ID: **T1423**



22 Pieces 1/4" mm

**1/4" SOCKET SET 6 PT 22 PIECES**

- Regular 6 point single hexagon sockets for a better grip
- Chrome vanadium satin finish sockets
- A selection of screwdriver and TX bits
- Supplied in the unique TengTools case with a snap lock
- Hard wearing hinge with a metal pin for longer life
- Designed and manufactured to DIN and ISO standards

72 Teeth ratchet						
Coupler adaptor, 2" Extension bar						
Regular 6 point sockets:						
mm:	4	5	5.5	6	7	8 10 12 13
1/4" Hex bits:	⊖ 4, 5.5, 6.5	⊕ TX10, TX15, TX20				
	⊕ PH1, PH2	⊕ PZ1, PZ2				

Item ID: **T1422**



24 Pieces 1/4" mm

**1/4" SOCKET SET 6 PT 24 PIECES**

- Regular 6 point single hexagon sockets for a better grip
- Chrome vanadium satin finish sockets
- A selection of screwdriver, hex and TX bits
- Supplied in the unique TengTools case with a snap lock
- Hard wearing hinge with a metal pin for longer life
- Designed and manufactured to DIN and ISO standards

Flip reverse ratchet						
3" Extension bar, Universal Joint, Bits holder						
Regular 6 point sockets:						
mm:	4	5	5.5	6	7	8 10 11 12 13
1/4" Hex bits:	⊖ 4, 5.5	⊕ TX10, TX15, TX20				
	⊕ PH1, PH2	⊕ 3, 5, 6				

Item ID: **T1424**



24 Pieces 1/4" mm

**1/4" SOCKET SET FLEXIBLE RATCHET 6 PT**

- Regular 6 point single hexagon sockets for a better grip
- Chrome vanadium satin finish sockets
- A selection of screwdriver, hex and TX bits
- Supplied in the unique TengTools case with a snap lock
- Hard wearing hinge with a metal pin for longer life
- Designed and manufactured to DIN and ISO standards

72 Teeth flexible ratchet

3" Extension bar, Universal Joint, Coupler adaptor

Regular 6 point sockets:

mm:	4	5	5.5	6	7	8	10	11	12	13		
1/4" Hex bits:	PH1, PH2		TX10, TX15, TX20								3, 5, 6	

Item ID: **T1424S**



35 Pieces 1/4" AF

**1/4" SOCKET SET 6 PT AF 35 PIECES**

- Regular and deep 6 point single hexagon sockets
- Chrome vanadium satin finish sockets
- A selection of screwdriver, hex and TX bits
- Supplied in the unique TengTools case with a snap lock
- Hard wearing hinge with a metal pin for longer life
- Designed and manufactured to DIN and ISO standards

Flip reverse ratchet, Universal Joint, Hex Keys: 1.5, 2 & 2.5mm

Coupler adaptor, 2" & 4" Extension bars, 3/8" F x 1/4" M T-bar adaptor

6 point sockets:

Reg AF:	3/16	7/32	1/4	9/32	5/16	11/32	3/8	7/16	1/2	
Deep AF:	3/16	1/4	5/16	3/8	7/16	1/2				
1/4" Hex bits:	PH1, PH2		TX10, TX15, TX20				5, 6			
	PZ1, PZ2									

Item ID: **T1435AF**





36 Pieces 1/4" mm

**1/4" SOCKET SET 6 PT 36 PIECES**

- Regular and deep 6 point single hexagon sockets for a better grip
- Chrome vanadium satin finish sockets
- A selection of screwdriver, hex and TX bits
- Supplied in the unique TengTools case with a snap lock
- Hard wearing hinge with a metal pin for longer life
- Designed and manufactured to DIN and ISO standards

Flip reverse ratchet, Universal Joint, Hex Keys: 1.5, 2 & 2.5mm

Coupler adaptor, 2" & 4" Extension bars, 3/8" F x 1/4" M T-bar adaptor

6 point sockets:

Reg mm: 4 5 5.5 6 7 8 10 11 12 13

Deep mm: 6 7 8 10 12 13

1/4" Hex bits: 4, 5.5 TX10, TX15, TX20 5, 6  
 PH1, PH2 PZ1, PZ2

Item ID: **T1436**



**TT SERIES** Socket Sets available

**MODULAR TOOL CONTROL SYSTEM**



**PAGE 55**

**MECCA PRO™**



60 Pieces 1/4" mm AF

**MECCA PRO 1/4" SOCKET SET 6 PT 60 PIECES**

- Regular and deep 6 point single hexagon sockets for a better grip
- Chrome vanadium satin finish sockets
- A selection of screwdriver, hex and TX bits
- Supplied in the unique TengTools carrying case
- Hard wearing case
- Tools clearly laid out to easily identify which tool belongs where
- Designed and manufactured to DIN and ISO standards

Flip reverse ratchet, Universal Joint, Spinner handle

Coupler adaptor, 2" & 4" Extension bars, 3/8" F x 1/4" M T-bar adaptor

6 point sockets:

Reg mm: 4 4.5 5 5.5 6 7 8 9  
 10 11 12 13

Reg AF: 3/16 7/32 1/4 9/32 5/16 11/32 3/8 7/16 1/2

Deep mm: 6 7 8 10 12 13

Deep AF: 1/4 5/16 3/8 7/16 1/2

1/4" drive bit sockets:

mm: 4 5.5 7

TX: 10 15 20 25 27

PH: 1 2

1/4" Hex bits: 4, 5.5 5, 6

PH1, PH2 PZ1, PZ2

Item ID: **T1460**



12 Pieces 1/4" mm

**1/4" SOCKET CLIP RAIL SET 6 PT 12 PIECES**

- 6 point single hexagon socket for a better grip
- Chrome vanadium
- Satin finish for a better grip when handling the socket
- Ball bearing recess on the female end to grip the ratchet
- Clip rail with socket clips for easy storage as a set
- Designed and manufactured to DIN3120/3124 and ISO2725

Clip rail (Length 185mm), 1/4" drive socket clips x12

Regular 6 point sockets:

O	mm:	4	4.5	5	5.5	6	7
		8	9	10	11	12	13

Item ID: **M1412**



9 Pieces 1/4" mm

**1/4" DEEP SOCKET CLIP RAIL SET 6 PT 9 PIECES**

- Long sockets for extra reach
- Chrome vanadium
- Satin finish for a better grip when handling the socket
- 6 point single hexagon socket for a better grip
- Ball bearing recess on the female end to grip the ratchet
- Clip rail with socket clips for easy storage as a set
- Designed and manufactured to DIN3120/3124 and ISO2725

Clip rail (Length 165mm), 1/4" drive socket clips x9

Deep 6 point sockets:

O	mm:	4	5	6	7	8	9	10	12	13
---	-----	---	---	---	---	---	---	----	----	----

Item ID: **M1407**



7 Pieces 1/4"

**1/4" TX BIT SOCKET CLIP RAIL SET 8 PIECES**

- All the most commonly used sizes in one handy set
- Chrome vanadium
- S2 steel bits pressed in to the socket
- Satin finish for a better grip when handling the socket
- Designed for use with TX fastenings
- Clip rail with socket clips for easy storage as a set

Clip rail (Length 110mm), 1/4" drive socket clips x7

TX bit sockets:

TX	10	15	20	25	27	30	40
----	----	----	----	----	----	----	----

Item ID: **M1408TX**



**FOAM SERIES**

Socket Sets available

**MODULAR TOOL CONTROL SYSTEM**



**PAGE 122**

3/8" DRIVE



3/8" SOCKET SET 6 PT 12 PIECES

- A basic no nonsense set of 3/8" drive sockets
- Chrome vanadium
- 6 point single hexagon sockets for a better fit
- Ball bearing recess on the female end to grip the ratchet
- Designed and manufactured to DIN and ISO standards
- Supplied in a handy pocket sized holder with a clip rail facility for adding additional sockets or accessories

Flip Reverse Ratchet, 3" Extension Bar

Regular 6 point sockets:

mm:	8	10	11	12	13	14
	15	16	17	19		

Item ID: M3812N1



3/8" SOCKET SET 6 PT 34 PIECES

- Regular 6 point single hexagon sockets for a better grip
- Chrome vanadium satin finish sockets
- A selection of screwdriver, hex and TX bits
- Supplied in the unique TengTools case with a snap lock
- Hard wearing hinge with a metal pin for longer life
- Designed and manufactured to DIN and ISO standards

Flip Reverse Ratchet, 3" & 6" Extension Bars

Coupler adaptor, 1/2" F x 3/8" M T-bar adaptor

Regular 6 point sockets:

mm:	8	10	11	12	13	14	15	17	19
1/4" Hex bits:	-			3, 4, 5.5	+			TX10, TX15, TX20, TX25, TX27, TX30, TX40	
	+			PH1, PH2, PH3	+			PZ1, PZ2, PZ3	3, 4, 5, 6

Item ID: T3834





34 Pieces 3/8" mm

**3/8" SOCKET SET FLEXIBLE RATCHET 6 PT**

- Includes the TengTools stubby flex head ratchet
- Regular 6 point single hexagon sockets for a better grip
- Chrome vanadium satin finish sockets
- A selection of screwdriver, hex and TX bits
- Supplied in the unique TengTools case with a snap lock
- Designed and manufactured to DIN and ISO standards

72 Teeth flexible head ratchet, 3" & 6" Extension Bars

Coupler adaptor, 1/2" F x 3/8" M T-bar adaptor

Regular 6 point sockets:

mm:	8	10	11	12	13	14	15	17	19
1/4" Hex bits:	3, 4, 5.5	TX10, TX15, TX20, TX25, TX27, TX30, TX40							
	PH1, PH2, PH3	PZ1, PZ2, PZ3						3, 4, 5, 6	

Item ID: **T3834S**

**MECCA PRO™**



35 Pieces 3/8" AF

**MECCA PRO 3/8" SOCKET SET 6 PT AF 35 PIECES**

- Regular and deep 6 point single hexagon sockets for a better grip
- Chrome vanadium satin finish sockets
- A selection of screwdriver, hex and TX bits
- Hard wearing case
- Tools clearly laid out to easily identify which tool belongs where
- Designed and manufactured to DIN and ISO standards

Flip reverse ratchet, Universal joint, 4" & 6" Extension Bars

Coupler adaptor, 1/2" F x 3/8" M T-bar adaptor

6 point sockets:

Reg AF: 5/16 3/8 7/16 1/2 9/16 5/8 11/16 3/4 13/16 7/8

Deep AF: 3/8 7/16 1/2 9/16 11/16 3/4

Spark Plug Sockets mm: 16 21

1/4" Hex bits:	4, 5.5	TX10, TX15, TX20	5, 6
	PH1, PH2	PZ1, PZ2	

Item ID: **T3835AF**



**TT SERIES**

Socket Sets available

**MODULAR TOOL CONTROL SYSTEM**



**PAGE 55**

**FOAM SERIES**

Socket Sets available

**MODULAR TOOL CONTROL SYSTEM**



**PAGE 122**



MECCA PRO™



39 Pieces 3/8" mm

MECCA PRO 3/8" SOCKET SET 6 PT 39 PIECES

- Regular and deep 6 point single hexagon sockets for a better grip
- Chrome vanadium satin finish sockets
- A selection of screwdriver, hex and TX bits
- Hard wearing case
- Tools clearly laid out to easily identify which tool belongs where
- Designed and manufactured to DIN and ISO standards

Flip reverse ratchet, Universal joint, 3" Wobble extension bar, 6" Extension Bar

Coupler adaptor, 1/2"F x 3/8"M T-bar adaptor

6 point sockets:

Reg mm:	8	9	10	11	12	13	14	15	16	17
	18	19	21	22						

Deep mm:	8	10	12	13	17	19					
----------	---	----	----	----	----	----	--	--	--	--	--

Spark Plug Sockets mm: 16 21

1/4" Hex bits:	⊖ 4, 5, 5	⊕ TX10, TX15, TX20	⊕ 5, 6
	⊕ PH1, PH2	⊕ PZ1, PZ2	

Item ID: T3839



**TT SERIES** Socket Sets available

MODULAR TOOL CONTROL SYSTEM



PAGE 55

MECCA PRO™



39 Pieces 3/8" mm

MECCA PRO 3/8" SOCKET & TOOL SET 39 PIECES

- Regular and 6 point single hexagon sockets for a better grip
- Combination spanners
- Chrome vanadium satin finish sockets and spanners
- A selection of screwdriver, hex and TX bits
- Hard wearing case
- Tools clearly laid out to easily identify which tool belongs where
- Designed and manufactured to DIN and ISO standards

Flip reverse ratchet, Universal joint, 6" Extension Bar

Coupler adaptor, 1/2"F x 3/8"M T-bar adaptor

Regular 6 point sockets:

mm:	8	9	10	11	12	13	14	15	16	17
	18	19	21	22						

Combination Spanners: 8, 10, 11, 12, 13, 14, 15, 17, 19 mm

1/4" Hex bits:	⊖ 4, 5, 5	⊕ TX10, TX15, TX20	⊕ 5, 6
	⊕ PH1, PH2	⊕ PZ1, PZ2	

Item ID: T3840

**FOAM SERIES** Socket Sets available

MODULAR TOOL CONTROL SYSTEM



PAGE 122

**MECCA PRO™**



48 Pieces 3/8" mm AF

**MECCA PRO 3/8" SOCKET & TOOL SET MM/AF**

- Regular 6 point single hexagon sockets for a better grip
- A range of combination spanners together with an adjustable wrench, power grip plier, pliers and screwdrivers
- Chrome vanadium satin finish sockets and spanners
- Hard wearing case
- Tools clearly laid out to easily identify which tool belongs where
- Designed and manufactured to DIN and ISO standards

Flip reverse ratchet, Universal Joint, 3" & 6" Extension bars	
Coupler adaptor, 1/2" F x 3/8" M T-bar adaptor	
Regular 6 point sockets:	
mm:	8 10 12 13 14 15 16 17 18 19 21
AF:	7/16 1/2 9/16 11/16
Spark Plug Sockets mm:	16 21
Combination Spanners:	8, 10, 12, 13, 14, 15, 16, 17, 18, 19 mm 7/16", 1/2", 9/16", 11/16"
Screwdrivers:	3 5.5 6.5 PH0 PH1 PH2
Pliers:	6" Side Cutters, 7" Combination, 8" Long Nose, 10" Water Pump
Power Grip Pliers:	7" Curved jaw
Adjustable Wrench:	8" Phosphate Finish

Item ID: **T3848**

**MECCA PRO™**



67 Pieces 3/8" mm

**MECCA PRO 3/8" SOCKET & TOOL SET 67 PIECES**

- Regular 6 point single hexagon sockets for a better grip
- A range of combination spanners, pliers and screwdrivers
- Chrome vanadium satin finish sockets and spanners
- A selection of screwdriver, hex and TX bits
- Hard wearing case
- Tools clearly laid out to easily identify which tool belongs where
- Designed and manufactured to DIN and ISO standards

Flip reverse ratchet, 3" & 6" Extension bars, Bits driver, Magnetic bits holder	
Coupler adaptor, 1/2" F x 3/8" M T-bar adaptor	
Regular 6 point sockets:	
mm:	8 9 10 11 12 13 14 15 16 17 18 19 20 22
Combination Spanners:	8, 10, 11, 12, 13, 14, 15, 16, 17, 19 mm
Screwdrivers:	3 5.5 6.5 PH0 PH1 PH2
Pliers:	6" Side Cutters, 7" Combination, 8" Long Nose, 10" Water Pump
1/4" Hex bits:	TX8, TX10, TX15, TX20, TX25, TX27, TX30, TX40, TX45, TX50 3, 4, 5, 6, 8, 10 PH0, PH1, PH2, PH3 4, 5, 5, 7 PZ1, PZ2, PZ3

Item ID: **T3867**



**NEW**

**MECCA PRO™**



80 Pieces 3/8" mm

**MECCA PRO 3/8" SOCKET & TOOL SET 80 PIECES**

- Regular 6 point single hexagon sockets for a better grip.
- Combination spanners, adjustable wrench, a hex key set, LED light, utility knife, hook and pick set. Measuring tape, foldable saw, claw hammer, magnetic pick up, pliers and screwdrivers.
- Chrome vanadium satin finish sockets and spanners.
- Hard wearing case
- Tools clearly laid out to easily identify which tool belongs were.
- Designed and manufactured to DIN and ISO standards.

Flip reverse ratchet, 5" Extension bar, Universal Joint, Bits driver, Magnetic bits holder

Coupler adaptor, 1/2" F x 3/8" M T-bar adaptor

Regular 6 point sockets:

mm:	8	10	11	12	13	14	15	17	19
	20	21	22						

LED Light with clip, 5m Measuring tape, Utility knife, Telescopic magnet, Folding Utility Saw with 2 blades, Hook & pick set, 16oz claw hammer, Folding hex key set, 8" wide jaw adjustable wrench

Combination Spanners:	6, 7, 8, 10, 11 mm							
Screwdrivers:		3	5.5	6.5		PH1	PH2	
Pliers:	6" Side Cutters, 7" Combination, 8" Long Nose, 10" Water Pump							
1/4" Hex bits:		TX10, TX15, TX20, TX25, TX27, TX30, TX40		4.5, 5.5, 6.5				
		TPX20, TPX25, TPX30		PH1, PH2, PH3, PH2G (x2)				
		4, 5, 6		PZ1, PZ2, PZ3		1, 2, 3		

Item ID: **TM080**



16 Pieces 3/8" mm

**3/8" SOCKET CLIP RAIL SET 6 PT 16 PIECES**

- 6 point single hexagon socket for a better grip
- Chrome vanadium
- Satin finish for a better grip when handling the socket
- Ball bearing recess on the female end to grip the ratchet
- Supplied with a clip rail with socket clips for easy storage as a set
- Designed and manufactured to DIN3120/3124 and ISO2725

Clip rail (Length: 370mm), 3/8" Drive socket clips x16

Regular 6 point sockets:

mm:	7	8	9	10	11	12	13	14
	15	16	17	18	19	20	21	22

Item ID: **M3816**



7 Pieces 3/8" mm

**3/8" DEEP SOCKET CLIP RAIL SET 6 PT 7 PIECES**

- Long sockets for extra reach
- Chrome vanadium
- Satin finish for a better grip when handling the socket
- 6 point single hexagon socket for a better grip
- Ball bearing recess on the female end to grip the ratchet
- Supplied with a clip rail with socket clips for easy storage as a set
- Designed and manufactured to DIN3120/3124 and ISO2725

Clip rail (Length: 165mm), 3/8" Drive socket clips x7

Deep 6 point sockets:

mm:	10	12	13	14	15	17	19
-----	----	----	----	----	----	----	----

Item ID: **M3807**



9 Pieces 3/8" mm

**3/8" HEX BIT SOCKET CLIP RAIL SET 9 PIECES**

- Chrome vanadium
- S2 steel bits pressed in to the socket
- Satin finish for a better grip when handling the socket
- Designed for use with fastenings with a hexagon hole
- Use with in-hex screws or grub screws
- Designed and manufactured to DIN7422
- Supplied with a clip rail with socket clips for easy storage as a set

Clip rail (Length: 165mm), 3/8" Drive socket clips x9

3/8" Drive Hex bit sockets - Length 49.5mm:

	mm:	3	4	5	5.5	6	7	8	10	12
--	-----	---	---	---	-----	---	---	---	----	----

Item ID: **M3812**



**MECCA PRO™**

**SOCKET SETS**  
IN DURABLE, SHOCKPROOF CASES

**SECURE LOCK SYSTEM** with click mechanism so you know the top is closed properly

**HARD-WEARING HINGE** with metal pin for increased life

**RETRACTABLE HANDLE**, especially designed for comfort and durability.

**CLEAR LAYOUT** makes it easier to see which tools are missing

**RUBBER FEET** to prevent the box from sliding and which protects against scratching

**FULLY RECYCLABLE** packaging that helps the environment



**TT SERIES**

Socket Sets available

**MODULAR TOOL CONTROL SYSTEM**



**PAGE 55**

**FOAM SERIES**

Socket Sets available

**MODULAR TOOL CONTROL SYSTEM**



**PAGE 122**

NEW



9 Pieces 3/8" mm

### 3/8" HEX BIT SOCKET CLIP RAIL SET 100MM

- Chrome vanadium
- S2 steel bits pressed into the socket
- Satin finish for a better grip when handling the socket
- Ball recess on the female end to grip the ratchet
- Designed for use with fastenings with a hexagon hole
- Use with in-hex screws or grub screws
- Designed and manufactured to DIN7422
- Supplied on a metal clip rail

Clip rail (Length: 165mm), 3/8" Drive socket clips x9

3/8" Drive Hex bit sockets - Length 100mm:

mm: 3 4 5 5.5 6 7 8 10 12

Item ID: **M3809**



8 Pieces 3/8" AF

### 3/8" HEX BIT SOCKET CLIP RAIL SET AF

- Chrome vanadium
- S2 steel bits pressed in to the socket
- Satin finish for a better grip when handling the socket
- Designed for use with fastenings with a hexagon hole
- Use with in-hex screws or grub screws
- Supplied with a clip rail with socket clips for easy storage as a set

Clip rail (Length: 165mm), 3/8" Drive socket clips x8

3/8" Drive Hex bit sockets - Length 49.5mm:

AF: 3/32 1/8 5/32 3/16 7/32 1/4 5/16 3/8

Item ID: **M3811**



9 Pieces 3/8"

### 3/8" TPX BIT SOCKET CLIP RAIL SET 9 PIECES

- Chrome vanadium
- S2 steel bits pressed in to the socket
- Satin finish for a better grip when handling the socket
- Designed for use with tamper proof TX fastenings
- Supplied with a clip rail with socket clips for easy storage as a set

Clip rail (Length: 165mm), 3/8" Drive socket clips x9

3/8" Drive TPX bit sockets - Length 49.5mm:

TPX: 10 15 20 25 27 30 40 45 50

Item ID: **M3813TPX**



9 Pieces 3/8"

### 3/8" TX BIT SOCKET CLIP RAIL SET 9 PIECES

- Chrome vanadium
- S2 steel bits pressed in to the socket
- Satin finish for a better grip when handling the socket
- Designed for use with TX fastenings
- Supplied with a clip rail with socket clips for easy storage as a set

Clip rail (Length: 165mm), 3/8" Drive socket clips x9

3/8" Drive TX bit sockets - Length 49.5mm:

TX: 10 15 20 25 27 30 40 45 50

Item ID: **M3813TX**

**NEW**



9 Pieces 3/8"

**3/8" TX BIT SOCKET CLIP RAIL SET 100MM**

- Chrome vanadium
- S2 steel bits pressed into the socket
- Satin finish for a better grip when handling the socket
- Ball recess on the female end to grip the ratchet
- Designed for use with fastenings with a TX hole
- Supplied on a metal clip rail

Clip rail (Length: 165mm), 3/8" Drive socket clips x9

3/8" Drive TX bit sockets - Length 100mm:

TX:	10	15	20	25	27	30	40	45	50
-----	----	----	----	----	----	----	----	----	----

Item ID: **M3809TX**

**NEW**



6 Pieces 3/8"

**3/8" RIBE BIT SOCKET CLIP RAIL SET 100MM**

- Chrome vanadium
- S2 steel bits pressed into the socket
- Satin finish for a better grip when handling the socket
- Ball recess on the female end to grip the ratchet
- Designed for use with fastenings with a multi spline Ribe type hole
- Supplied on a metal clip

Clip rail (Length: 165mm), 3/8" Drive socket clips x6

3/8" Drive Ribe bit sockets - Length 100mm:

Ribe:	04	05	06	08	09	10
-------	----	----	----	----	----	----

Item ID: **M3806**



10 Pieces 1/4" 3/8"

**1/4" & 3/8" TX-E SOCKET CLIP RAIL SET**

- TX-E Clip rail set
- Chrome vanadium
- Ball bearing recess on the female end to grip the ratchet
- Designed for use with protruding TX head screws
- Supplied with a clip rail with socket clips for easy storage as a set

Clip rail (Length: 165mm), 3/8" Drive socket clips x5, 1/4" Drive socket clips x5

3/8" Drive TX-E bit sockets - Length 28mm:

TX-E:	E10	E12	E14	E16	E18
-------	-----	-----	-----	-----	-----

1/4" Drive bit sockets:

TX-E:	E4	E5	E6	E7	E8
-------	----	----	----	----	----

Item ID: **M3814**



8 Pieces 3/8" mm

**3/8" CROW FOOT WRENCH CLIP RAIL SET**

- Open ended spanner at right angle to square drive
- Ideal for accessing confined spaces
- Use with a ratchet or torque wrench with an extension bar
- Satin finish chrome vanadium
- Supplied with a clip rail with socket clips for easy storage

3/8" Drive Crow Foot Wrenches

10, 11, 12, 13, 16, 17, 18, 19 mm

Item ID: **M3808MM**

**1/2" DRIVE**



12 Pieces 1/2" mm

**1/2" SOCKET SET 12 PT 12 PIECES**

- 12 point bi-hexagon sockets for easier alignment to the fastening
- Chrome vanadium
- Satin finish for a better grip when handling the socket
- Ball bearing recess on the female end to grip the ratchet
- Designed and manufactured to DIN and ISO standards
- Supplied in a handy pocket sized holder with a clip rail facility for adding additional sockets or accessories

Flip Reverse Ratchet, 5" Extension Bar						
Regular 12 point sockets:						
mm:	8	10	12	13	14	15
	17	18	19	24		

Item ID: **M1212N1**



**TT SERIES** Socket Sets available

**MODULAR TOOL CONTROL SYSTEM**

**PAGE 55**



20 Pieces 1/2" AF

**MECCA PRO 1/2" SOCKET SET 12 PT AF**

- 12 point bi-hexagon sockets for easier alignment to the fastening
- Chrome vanadium satin finish sockets
- Hard wearing case
- Tools clearly laid out to easily identify which tool belongs where
- Designed and manufactured to DIN and ISO standards

Flip reverse ratchet, 2 1/2" & 6" Extension bars										
Universal joint, 3/8" F x 1/2" M T-bar adaptor										
Regular 12 point sockets:										
AF:	3/8	7/16	1/2	9/16	5/8	11/16	3/4	13/16	7/8	
	15/16	1	1-1/16	1-1/8	1-3/16	1-1/4				

Item ID: **T1220AF**

**FOAM SERIES** Socket Sets available

**MODULAR TOOL CONTROL SYSTEM**

**PAGE 122**

**MECCA PRO™**



21 Pieces 1/2" mm

**MECCA PRO 1/2" SOCKET SET 12 PT 21 PIECES**

- 12 point bi-hexagon sockets for easier alignment to the fastening
- Chrome vanadium satin finish sockets
- Hard wearing case
- Tools clearly laid out to easily identify which tool belongs where
- Designed and manufactured to DIN and ISO standards

Flip reverse ratchet, 2½" & 6" Extension bars

Universal joint, 3/8" F x 1/2" M T-bar adaptor

Regular 12 point sockets:

⊙	mm:	10	11	12	13	14	15	16	17
		18	19	21	22	24	27	30	32

Item ID: **T1221**

**MECCA PRO**



21 Pieces 1/2" mm

**MECCA PRO 1/2" SOCKET SET 6 PT 21 PIECES**

- 6 point single hexagon sockets for a better grip
- Chrome vanadium satin finish sockets
- Hard wearing case
- Tools clearly laid out to easily identify which tool belongs where
- Designed and manufactured to DIN and ISO standards

Flip reverse ratchet, 2½" & 6" Extension bars

Universal joint, 3/8" F x 1/2" M T-bar adaptor

Regular 6 point sockets:

⊙	mm:	10	11	12	13	14	15	16	17
		18	19	21	22	24	27	30	32

Item ID: **T1221-6**





MECCA PRO™



34 Pieces 1/2" mm

MECCA PRO 1/2" SOCKET SET 6 PT 34 PIECES

- 6 point single hexagon sockets for a better grip
- Chrome vanadium satin finish sockets
- Hard wearing case
- Tools clearly laid out to easily identify which tool belongs where
- Designed and manufactured to DIN and ISO standards

Flip reverse ratchet, 5" & 10" Extension bars								
Universal joint, 3/8"F x 1/2"M T-bar adaptor, Hex keys: 1.5, 2, 2.5mm								
6 point sockets:								
○ Reg mm:	10	11	12	13	14	15	16	17
	18	19	20	21	22	23	24	27
○ Deep mm:	13	14	15	16	17	18	19	24
Spark plug sockets mm:	16		21					

Item ID: T1234



**TT**  
SERIES Socket Sets available

MODULAR TOOL CONTROL SYSTEM



PAGE 55

MECCA PRO™



44 Pieces 1/2" mm AF

MECCA PRO 1/2" SOCKET & TOOL SET MM/AF

- Regular and deep 12 point bi-hexagon sockets for easier alignment to the fastening
- Chrome vanadium satin finish sockets
- 10x13mm "Rigger Jigger" double ring spanner and screwdrivers
- Hard wearing case
- Tools clearly laid out to easily identify which tool belongs where
- Designed and manufactured to DIN and ISO standards

Flip reverse ratchet, 17" Flex handle, 2 1/2", 5" & 10" Extension bars									
Universal joint, 3/8"F x 1/2"M T-bar adaptor									
Regular 12 point sockets:									
○ AF:	3/8	1/2	9/16	19/32	11/16	25/32	13/16	1	
○ mm:	10	11	12	13	14	15	16	17	18
	19	20	21	22	23	24	27	30	32
Deep 12 point sockets:									
○ mm:	10	13	17	19					
Spark plug sockets mm:	16		21						
Screwdrivers:	⊖ 5.5		6.5		⊕ PZ1		PZ2		
Double ring spanner:	10 x 13mm (Rigger Jigger)								

Item ID: T1244

**FOAM**  
SERIES Socket Sets available

MODULAR TOOL CONTROL SYSTEM



PAGE 122

**MECCA PRO™**



68 Pieces 1/2" mm

**MECCA PRO 1/2" SOCKET & TOOL SET 68 PIECES**

- 12 point bi-hexagon sockets for easier alignment to the fastening
- A range of combination spanners, pliers and screwdrivers
- Chrome vanadium satin finish sockets and spanners
- Hard wearing case
- Tools clearly laid out to easily identify which tool belongs where
- Designed and manufactured to DIN and ISO standards

Flip reverse ratchet, 2 1/2" & 6" Extension bars, Bits driver, Magnetic bits holder

Universal joint, 3/8" F x 1/2" M T-bar adaptor

Regular 12 point sockets:

mm:	10	11	12	13	14	15	16	17	18
	19	21	22	27	30	32			

Combination spanners: 8, 10, 11, 12, 13, 14, 15, 16, 17, 19 mm

Screwdrivers: 3 5.5 6.5 PH0 PH1 PH2

Pliers: 6" Side cutter, 7" Combination, 8" Long nose, 10" Water pump

1/4" Hex bits: TX8, TX10, TX15, TX20, TX25, TX27, TX30, TX40, TX45, TX50

3, 4, 5, 6, 8, 10 4, 5.5, 7 PZ1, PZ2, PZ3

PH0, PH1, PH2, PH3

Item ID: **T1268**



15 Pieces 1/2" mm

**1/2" SOCKET CLIP RAIL SET 12 PT 15 PIECES**

- 12 point bi-hexagon socket for easier alignment to the fastening
- Chrome vanadium
- Satin finish for a better grip when handling the socket
- Ball bearing recess on the female end to grip the ratchet
- Supplied with a clip rail with socket clips for easy storage as a set
- Designed and manufactured to DIN3120/3124 and ISO2725

Clip rail (Length: 430mm), 1/2" Drive socket clips x15

Regular 12 point sockets:

mm:	10	12	13	14	15	16	17	18	19
	21	22	24	27	30	32			

Item ID: **M1215MM**



8 Pieces 1/2" mm

**1/2" DEEP SOCKET CLIP RAIL SET 12 PT 8 PIECES**

- Long sockets for extra reach
- Chrome vanadium
- Satin finish for a better grip when handling the socket
- 12 point bi-hexagon socket for easier alignment to the fastening
- Ball bearing recess on the female end to grip the ratchet
- Supplied with a clip rail with socket clips for easy storage as a set
- Designed and manufactured to DIN3120/3124 and ISO2725

Clip rail (Length: 210mm), 1/2" Drive socket clips x8

Deep 12 point sockets:

mm:	13	14	15	17	19	21	22	24
-----	----	----	----	----	----	----	----	----

Item ID: **M1207**



15 Pieces 1/2" mm

**1/2" SOCKET CLIP RAIL SET 12 PT AF 15 PIECES**

- 12 point bi-hexagon socket for easier alignment to the fastening
- Chrome vanadium
- Satin finish for a better grip when handling the socket
- Ball bearing recess on the female end to grip the ratchet
- Supplied with a clip rail with socket clips for easy storage as a set
- Designed and manufactured to DIN3120/3124 and ISO2725

Clip rail (Length: 430mm), 1/2" Drive socket clips x15

Regular 12 point sockets:

AF:	3/8	7/16	1/2	9/16	5/8	11/16	3/4	13/16	7/8
	15/16	1	1-1/16	1-1/8	1-3/16	1-1/4			

Item ID: **M1215AF**



9 Pieces 1/2" mm

**1/2" HEX BIT SOCKET CLIP RAIL SET 9 PIECES**

- Chrome vanadium
- S2 steel bits pressed in to the socket
- Satin finish for a better grip when handling the socket
- Designed for use with fastenings with a hexagon hole
- Use with in-hex screws or grub screws
- Designed and manufactured to DIN7422
- Supplied with a clip rail with socket clips for easy storage as a set

Clip rail (Length: 220mm), 1/2" Drive socket clips x9

Hex bit sockets:

mm:	5	6	7	8	9	10	12	14	17
-----	---	---	---	---	---	----	----	----	----

Item ID: **M1212**



8 Pieces 1/2" mm

**1/2" DEEP SOCKET CLIP RAIL SET 6 PT 8 PIECES**

- Long sockets for extra reach
- Chrome vanadium
- Satin finish for a better grip when handling the socket
- 6 point single hexagon socket for a better grip
- Ball bearing recess on the female end to grip the ratchet
- Supplied with a clip rail with socket clips for easy storage as a set
- Designed and manufactured to DIN3120/3124 and ISO2725

Clip rail (Length: 210mm), 1/2" Drive socket clips x8

Deep 6 point sockets:

mm:	13	14	15	17	19	21	22	24
-----	----	----	----	----	----	----	----	----

Item ID: **M1208-6**



9 Pieces 1/2" AF

**1/2" HEX BIT SOCKET CLIP RAIL SET AF**

- Chrome vanadium
- S2 steel bits pressed in to the socket
- Satin finish for a better grip when handling the socket
- Designed for use with fastenings with a hexagon hole
- Use with in-hex screws or grub screws
- Designed and manufactured to DIN7422
- Supplied with a clip rail with socket clips for easy storage as a set

Clip rail (Length: 220mm), 1/2" Drive socket clips x9

Hex bit sockets:

AF:	3/16	7/32	1/4	9/32	5/16	3/8	1/2	9/16	5/8
-----	------	------	-----	------	------	-----	-----	------	-----

Item ID: **M1209AF**



6 Pieces 1/2" mm

### 1/2" LONG HEX BIT SOCKET CLIP RAIL SET

- Chrome vanadium
- 100mm long bits for reaching in to recesses
- S2 steel bits pressed in to the socket
- Satin finish for a better grip when handling the socket
- Designed for use with fastenings with a hexagon hole
- Use with in-hex screws or grub screws
- Designed and manufactured to DIN7422
- Supplied with a clip rail with socket clips for easy storage as a set

Clip rail (Length: 160mm), 1/2" Drive socket clips x6

Hex bit sockets (Length 100mm):

mm: 5 6 7 8 10 12

Item ID: **M1211**



9 Pieces 1/2"

### 1/2" TX-E SOCKET CLIP RAIL SET 9 PIECES

- Chrome vanadium
- Satin finish for a better grip when handling the socket
- Ball bearing recess on the female end to grip the ratchet
- Designed for use with protruding TX head screws
- Supplied with a clip rail with socket clips for easy storage as a set

Clip rail (Length: 220mm), 1/2" Drive socket clips x9

TX-E bit sockets:

TX-E: E10 E11 E12 E14 E16 E18 E20 E22 E24

Item ID: **M1210**



9 Pieces 1/2"

### 1/2" TPX BIT SOCKET CLIP RAIL SET

- Chrome vanadium
- S2 steel bits pressed in to the socket
- Satin finish for a better grip when handling the socket
- Designed for use with tamper proof TX fastenings
- Supplied with a clip rail with socket clips for easy storage as a set

Clip rail (Length: 220mm), 1/2" Drive socket clips x9

TPX bit sockets:

TPX: 20 25 27 30 40 45 50 55 60

Item ID: **M1213TPX**



9 Pieces 1/2"

### 1/2" TX BIT SOCKET CLIP RAIL SET 9 PIECES

- Chrome vanadium
- S2 steel bits pressed in to the socket
- Satin finish for a better grip when handling the socket
- Designed for use with TX fastenings
- Supplied with a clip rail with socket clips for easy storage as a set

Clip rail (Length: 220mm), 1/2" Drive socket clips x9

TX bit sockets:

TX: 20 25 27 30 40 45 50 55 60

Item ID: **M1213TX**





9 Pieces 1/2"

**1/2" TX BIT SOCKET CLIP RAIL SET 100MM**

- Chrome vanadium
- S2 steel bits pressed into the socket
- Satin finish for a better grip when handling the socket
- Ball recess on the female end to grip the ratchet
- Designed for use with fastenings with a TX hole
- Supplied on a metal clip rail

Clip rail (Length: 220mm), 1/2" Drive socket clips x9

TX bit sockets (Length 100mm):

TX:	20	25	27	30	40	45	50	55	60
-----	----	----	----	----	----	----	----	----	----

Item ID: **M1209TX**

**NEW**



9 Pieces 1/2"

**1/2" RIBE SOCKET CLIP RAIL SET 100MM**

- Chrome vanadium
- S2 steel bits pressed into the socket
- Satin finish for a better grip when handling the socket
- Ball recess on the female end to grip the ratchet
- Designed for use with fastenings with a multi spline Ribe type hole
- Supplied on a metal clip

Clip rail (Length: 220mm), 1/2" Drive socket clips x9

Ribe bit sockets (Length 100mm):

Ribe:	04	05	06	08	09	10	11	12	13
-------	----	----	----	----	----	----	----	----	----

Item ID: **M1209**

**3/4" DRIVE**

**MECCA PRO™**



18 Pieces 3/4" mm

**MECCA PRO 3/4" SOCKET SET 6 PT 18 PIECES**

- Regular 6 point single hexagon sockets for a better grip
- Chrome vanadium satin finish sockets
- Supplied in the unique TengTools carrying case
- Hard wearing case
- Tools clearly laid out to easily identify which tool belongs where
- Designed and manufactured to DIN and ISO standards

Quick release 72 teeth ratchet, 200mm & 400mm Extension bars

Sliding T-bar

Regular 6 point sockets:

mm:	19	21	22	24	27	30	32	33	34
	36	38	41	46	50				

Item ID: **T3418-6**



**TT SERIES**

Socket Sets available

**MODULAR TOOL CONTROL SYSTEM**



**PAGE 55**

**1" DRIVE**



15 Pieces 1" mm

**1" SOCKET SET 12 PT 15 PIECES**

- Regular 12 point bi-hexagon sockets
- Chrome vanadium satin finish sockets
- Supplied in a metal carrying case
- Designed and manufactured to DIN and ISO standards

Flip reverse ratchet head with quick release, 22" handle bar

T-bar adaptor, 200mm & 400mm Extension bars

Regular 12 point sockets:

mm:	36	41	46	50	55
	60	65	70	75	80

Item ID: **M1115MM**

**MIXED DRIVE**

**MECCA PRO™**



72 Pieces 1/4" 1/2" mm

**MECCA PRO 1/4" & 1/2" SOCKET SET**

- 6 point 1/4" drive single hexagon sockets for a better grip
- 12 point 1/2" drive bi-hexagon sockets for easier alignment
- Chrome vanadium satin finish sockets
- An extensive range of screwdriver, hex, XZN and TX bits
- Hard wearing case
- Tools clearly laid out to easily identify which tool belongs where
- Designed and manufactured to DIN and ISO standards

1/4" Drive Flip reverse ratchet, Bi-flex wrench, 4" Extension bar, Coupler adaptor

1/2" Drive Flip reverse ratchet, 5" & 10" Extension bars, Flex head adaptor, 3/8" F x 1/2" M T-bar adaptor, Universal joint

1/4" Drive Regular 6 point sockets:

mm:	4	5	5.5	6	7
	8	10	11	12	13

1/2" Drive Regular 12 point sockets:

mm:	10	11	12	13	14	15	16	17	18
	19	20	21	22	23	24	27		

Hex Keys 1.5, 2, 2.5 mm

1/4" Hex bits: TX8, TX10, TX15, TX20, TX25, TX27, TX30, TX40

1/8", 9/64", 5/32", 3/16", 7/32", 1/4", 3/8"

3, 4, 5, 6, 8, 10 PH0, PH1, PH2, PH3

PZ1, PZ2, PZ3 4, 5.5, 7 M5, M6

Item ID: **T1272**

**FOAM SERIES**

Socket Sets available

**MODULAR TOOL CONTROL SYSTEM**



**PAGE 122**

MECCA PRO™



95 Pieces 1/4" 1/2" mm

MECCA PRO 1/4" & 1/2" SOCKET & TOOL SET

- 6 point single hexagon sockets for a better grip
- Combination spanners, screwdrivers and screwdriver bits
- Chrome vanadium satin finish sockets and spanners
- Hard wearing case
- Tools clearly laid out to easily identify which tool belongs where
- Designed and manufactured to DIN and ISO standards

1/4" Drive	Flip reverse ratchet, Universal joint, 2" & 4" Extension bars, Sliding T-bar, Spinner handle, Coupler adaptor, 50mm Magnetic bit holder
1/2" Drive	Flip reverse ratchet, 5" & 10" Extension bars, 5/16" Hex coupler, 3/8" F x 1/2" M T-bar adaptor, Universal joint
1/4" Drive 6 point sockets:	
Reg mm:	4 4.5 5 5.5 6 7
	8 9 10 11 12 13
Deep mm:	4 5 6 7 8 9
	10 11 12 13
1/2" Drive 6 point sockets:	
Reg mm:	10 11 12 13 14 15 17
	19 22 24 27 30 32
Spark plug sockets mm:	21
Screwdrivers:	3 4 PH1 PH2 PZ1 PZ2
Combination Spanners:	8, 10, 12, 13, 14, 17 mm
1/4" Hex bits:	TX8, TX10, TX15, TX20, TX25, TX27, TX30, TX40
	3, 4, 5, 6, 8, 10 PH0, PH1, PH2, PH3, PH4
	PZ0, PZ1, PZ2, PZ3 4, 5.5, 7
5/16" Hex bits:	TX45, TX50, TX55

Item ID: **TM095**

MECCA PRO™



106 Pieces 1/4" 3/8" 1/2" mm

MECCA PRO 1/4", 3/8" & 1/2" SOCKET SET

- 6 point 1/4" & 3/8" drive sockets for a better grip
- 12 point 1/2" drive bi-hexagon sockets for easier alignment
- Combination spanners, double flex wrenches and adjustable wrench
- Chrome vanadium satin finish sockets and spanners
- Hard wearing case
- Tools clearly laid out to easily identify which tool belongs where
- Designed and manufactured to DIN and ISO standards

1/4" Drive	Flip reverse ratchet, Universal joint, 2" & 3" Extension bars, Bi-flex wrench, Coupler adaptor, Bits driver, Magnetic bit holder
3/8" Drive	Flip reverse ratchet, 3" & 6" Extension bars, Coupler adaptor, 3/8" F x 1/4" M, 3/8" F x 1/2" M T-bar adaptors, Universal joint
1/2" Drive	2 1/2" & 10" Extension bars, 1/2" F x 3/8" M T-bar adaptor, Flex head adaptor
1/4" Drive 6 point sockets:	
Reg mm:	4 5 6 7 8 10 12 13
Deep mm:	6 7 8 10 12 13
3/8" Drive 6 point sockets:	
Reg mm:	8 9 10 12 13 14 15
	16 17 18 19 21 22
Spark plug sockets mm:	16 21
1/2" Drive 12 point sockets:	
Reg mm:	19 24 27 30 32
Double flex wrenches:	8x9, 10x11, 12x13, 14x15 mm
Combination Spanners:	8, 9, 10, 11, 12, 13, 14, 15, 16, 17, 18, 19 mm
Adjustable wrench:	10"
1/4" Hex bits:	TX8, TX10, TX15, TX20, TX25, TX27, TX30, TX40
	TPX10, TPX15, TPX20, TPX25, TPX27, TPX30, TPX40
	3, 4, 5, 6, 8, 10 PH0, PH1, PH2, PH3
	PZ1, PZ2, PZ3 4, 5.5, 7 M5, M6

Item ID: **TM106**

**MECCA PRO™**



111 Pieces 1/4" 3/8" 1/2" mm AF

**MECCA PRO 1/4", 3/8" & 1/2" SOCKET SET MM/AF**

- Chrome vanadium satin finish sockets and spanners
- Supplied in the unique TengTools carrying case
- Hard wearing case
- Easy to identify which tool belongs where
- Designed and manufactured to DIN and ISO standards

1/4" Drive	Flip reverse ratchet, 5/16" Hex coupler, 6" Flexible extension, 2" & 4" Extension bars, Spinner handle, Universal joint, 1/4"F x 3/8"M adaptor, 4" T-bar
3/8" Drive	Flip reverse ratchet, 1/4" Hex bit holder, 3" & 6" Extension bars, Spinner handle, Universal joint, 3/8"F x 1/2"M adaptor, Spin disc
1/2" Drive	Flip reverse ratchet, 5/16" Hex coupler, 2 1/2" & 10" Extension bars, 1/2"F x 3/8"M adaptor, Spin disc
1/4" Drive 6 point sockets:	
Reg mm:	4 5 6 7 8 10 12
Reg AF:	3/16 7/32 1/4 9/32 3/8 7/16
3/8" Drive 6 point sockets:	
Reg mm:	8 9 10 12 13 14 15 16 17
Deep mm:	8 9 10 12 13 14 15 16 17
Reg AF:	3/8 7/16 1/2 9/16 11/16 3/4 13/16 7/8
Deep AF:	3/8 7/16 1/2 9/16 11/16 3/4 13/16 7/8
Spark plug sockets mm:	
	16 21
1/2" Drive 6 point sockets:	
Reg mm:	17 24 27 32
Reg AF:	11/16 3/4 13/16 7/8 1 1-3/16
1/4" Hex bits:	TX10, TX15, TX20, TX25, TX30, TX40 4, 5.5, 7
	3, 4, 5, 6, 7, 10 1/8", 9/64", 5/32", 3/16", 1/4", 5/16"
	PZ1, PZ2, PZ3 PH1, PH2, PH3
5/16" Hex bits:	TX45, TX50

Item ID: **TM111**

**MECCA PRO™**



127 Pieces 1/4" 3/8" 1/2" mm AF

**MECCA PRO 1/4", 3/8" & 1/2" SOCKET & TOOL SET**

- Chrome vanadium satin finish sockets and spanners
- A range of combination spanners and adjustable wrench
- Hard wearing case
- Easy to identify which tool belongs where
- Designed and manufactured to DIN and ISO standards

1/4" Drive	Flip reverse ratchet, Universal joint, 2" & 3" Extension bars, Coupler adaptor
3/8" Drive	Flip reverse ratchet, 3" & 6" Extension bars, Universal joint, Coupler adaptor, 3/8"F x 1/4"M adaptor, 3/8"F x 1/2"M adaptor
1/2" Drive	2 1/2" & 10" Extension bars, Flex head adaptor, 1/2"F x 3/8"M adaptor
1/4" Drive 6 point sockets:	
Reg mm:	4 5 5.5 6 7
	8 10 11 12 13
Deep mm:	6 7 8 10 12 13
Reg AF:	3/16 7/32 1/4 9/32 5/16 11/32 3/8 7/16 1/2
3/8" Drive 6 point sockets:	
Reg mm:	8 9 10 11 12 13 14
	15 16 17 18 19 21 22
Reg AF:	5/16 3/8 7/16 1/2 9/16
	5/8 11/16 3/4 13/16 7/8
Spark plug sockets mm:	
	16 21
1/2" Drive 12 point sockets:	
Reg mm:	19 24 27 30 32
Ratcheting bits driver, Spanner ring, 10" Adjustable wrench	
Combination Spanners: 8, 9, 10, 11, 12, 13, 14, 15, 16, 17, 18, 19 mm	
1/4" Hex bits:	TX8, TX10, TX15, TX20, TX25, TX27, TX30, TX40
	3, 4, 5, 6, 8, 10 1/8", 9/64", 5/32", 3/16", 1/4", 3/8"
	PZ1 (x2), PZ2 (x2), PZ3 PH0, PH1 (x2), PH3
	4, 5.5, 7 (x2) M5, M6

Item ID: **TM127**





**IMPACT**



6 Pieces 1/2" mm

**1/2" XZN IMPACT SOCKET SET DIN 6 PIECES**

- Chrome molybdenum with a manganese phosphate finish for added corrosion resistance
- Suitable for use with power tools
- DIN standard design for use with a retaining pin and ring
- Supplied in the unique TengTools case with a snap lock
- Hard wearing hinge with a metal pin for longer life

1/2" Drive Impact XZN bits sockets: 

	Length 43mm:	14	16	18
	Length 78mm:	14	16	18

Item ID: **T9206**



DIN Standard sockets require a retaining ring and pin to safely secure the socket to the impact tool.





22 Pieces 1/2" mm

**1/2" DR IMPACT METRIC STANDARD SOCKET SET**

- 18 regular metric sockets from 10 to 32 mm
- Retaining pins (2 pcs) and rings (2 pcs) included
- Made of chrome molybdenum (CR-MO)
- For use with power tools
- Supplied in a robust blow moulded box
- Designed and manufactured to DIN3129

Retaining rings & pins: O92194, O92244, P92320, P92325 x1

1/2" Drive Impact 6 point sockets: 

	Reg mm:	10	11	12	13	14	15	16	17	18
		19	21	22	24	27	28	29	30	32

Item ID: **T9222**



22 Pieces 1/2" mm

**1/2" DR IMPACT METRIC DEEP SOCKET SET**

- 18 deep metric sockets from 10 to 32 mm
- Retaining pins (2 pcs) and rings (2 pcs) included
- Made of chrome molybdenum (CR-MO)
- For use with power tools
- Supplied in a robust blow moulded box
- Designed and manufactured to DIN3129

Retaining rings & pins: O92194, O92244, P92320, P92325 x1

1/2" Drive Impact 6 point sockets: 

	Deep mm:	10	11	12	13	14	15	16	17	18
		19	21	22	24	27	28	29	30	32

Item ID: **T9222L**

**MECCA PRO™**

40 Pieces 1/2" mm

**1/2" DR IMPACT METRIC STD/DEEP SOCKET SET**

- Regular & deep metric sockets from 10 to 32 mm
- Retaining pins (2 pcs) and rings (2 pcs) included
- Made of chrome molybdenum (CR-MO)
- For use with power tools
- Supplied in a robust blow moulded box
- Designed and manufactured to DIN3129

Retaining rings &amp; pins: O92194, O92244, P92320, P92325 x1

1/2" Drive Impact 6 point sockets:

○ Reg mm:	10	11	12	13	14	15	16	17	18
	19	21	22	24	27	28	29	30	32
○ Deep mm:	10	11	12	13	14	15	16	17	18
	19	21	22	24	27	28	29	30	32

Item ID: **T9240****MECCA PRO™**

18 Pieces 1/2" AF

**1/2" DR IMPACT AF STANDARD SOCKET SET**

- 14 regular imperial sockets from 3/8" to 1-1/4"
- Retaining pins (2 pcs) and rings (2 pcs) included
- Made of chrome molybdenum (CR-MO)
- For use with power tools
- Supplied in a robust blow moulded box

Retaining rings &amp; pins: O92194, O92244, P92320, P92325 x1

1/2" Drive Impact 6 point sockets:

○ Reg AF:	3/8	7/16	1/2	9/16	5/8	11/16	3/4
	13/16	7/8	15/16	1	1-1/16	1-1/8	1-1/4

Item ID: **T9218AF****MECCA PRO™**

18 Pieces 1/2" AF

**1/2" DR IMPACT AF DEEP SOCKET SET**

- 14 deep imperial sockets from 3/8" to 1-1/4"
- Retaining pins (2 pcs) and rings (2 pcs) included
- Made of chrome molybdenum (CR-MO)
- For use with power tools
- Supplied in a robust blow moulded box

Retaining rings &amp; pins: O92194, O92244, P92320, P92325 x1

1/2" Drive Impact 6 point sockets:

○ Deep AF:	3/8	7/16	1/2	9/16	5/8	11/16	3/4
	13/16	7/8	15/16	1	1-1/16	1-1/8	1-1/4

Item ID: **T9218LAF****MECCA PRO™**

17 Pieces 3/4" mm

**3/4" DR IMPACT METRIC STANDARD SOCKET SET**

- 15 regular metric sockets from 19 to 50 mm
- Retaining pin and ring included
- Made of chrome molybdenum (CR-MO)
- For use with power tools
- Supplied in a robust blow moulded box
- Designed and manufactured to DIN3129

Retaining rings &amp; pins: O95036, P90435 x1

3/4" Drive Impact 6 point sockets:

○ Reg mm:	19	21	22	23	24	27	30	32
	33	34	36	38	41	46	50	

Item ID: **T9417**

MECCA PRO™



17 Pieces 3/4" mm

**3/4" DR IMPACT METRIC DEEP SOCKET SET**

- 15 deep metric sockets from 19 to 50 mm
- Retaining pin and ring included
- Made of chrome molybdenum (CR-MO)
- For use with power tools
- Supplied in a robust blow moulded box
- Designed and manufactured to DIN3129

Retaining rings & pins: O95036, P90435 x1

1/2" Drive Impact 6 point sockets:

○ Deep mm:	19	21	22	23	24	27	30	32
	33	34	36	38	41	46	50	

Item ID: T9417L

MECCA PRO™



23 Pieces 3/4" AF

**3/4" DR IMPACT AF STANDARD SOCKET SET**

- 21 regular imperial sockets from 11/16" to 2"
- Retaining pin and ring included
- Made of chrome molybdenum (CR-MO)
- For use with power tools
- Supplied in a robust blow moulded box

Retaining rings & pins: O95036, P90435 x1

1/2" Drive Impact 6 point sockets:

○ Reg AF:	11/16	3/4	13/16	7/8	15/16	1	1-1/16
	1-1/8	1-3/16	1-1/4	1-5/16	1-3/8	1-7/16	1-1/2
	1-9/16	1-5/8	1-11/16	1-3/4	1-7/8	1-15/16	2

Item ID: T9423AF

MECCA PRO™



21 Pieces 3/4" AF

**3/4" DR IMPACT AF DEEP SOCKET SET**

- 19 deep imperial sockets from 3/4" to 1-7/8"
- Retaining pin and ring included
- Made of chrome molybdenum (CR-MO)
- For use with power tools
- Supplied in a robust blow moulded box

Retaining rings & pins: O95036, P90435 x1

1/2" Drive Impact 6 point sockets:

○ Deep AF:	3/4	13/16	7/8	15/16	1	1-1/16	1-1/8
	1-3/16	1-1/4	1-5/16	1-3/8	1-7/16	1-1/2	1-9/16
	1-5/8	1-11/16	1-3/4	1-13/16	1-7/8		

Item ID: T9421LAF



8 Pieces 3/8" mm

**3/8" IMPACT SOCKET CLIP RAIL SET ANSI**

- ANSI standard design for use with power tools with a ball bearing socket retainer
- Chrome molybdenum for use with power tools
- Supplied on a 290mm clip rail for storage as a set

Clip rail (Length: 290mm), 3/8" Drive socket clips x8

Impact 6 point sockets:

○ Reg mm:	8	10	11	13	14	16	17	19
-----------	---	----	----	----	----	----	----	----

Item ID: 9381



8 Pieces 3/8" mm

### 3/8" DEEP IMPACT SOCKET CLIP RAIL SET ANSI

- ANSI standard design for use with power tools with a ball bearing socket retainer
- Chrome molybdenum for use with power tools
- Supplied on a 290mm clip rail for storage as a set

Clip rail (Length: 290mm), 3/8" Drive socket clips x8

Impact 6 point sockets:

○ Deep mm: 8 10 11 13 14 16 17 19

Item ID: **9386**



10 Pieces 1/2" mm

### 1/2" DEEP IMPACT SOCKET CLIP RAIL SET ANSI

- ANSI standard design for use with power tools with a ball bearing socket retainer
- Chrome molybdenum for use with power tools
- Supplied on a clip rail for storage as a set

Clip rail (Length: 290mm), 1/2" Drive socket clips x10

Impact 6 point sockets: 

○ Deep mm: 10 11 12 13 14  
17 19 21 22 24

Item ID: **9126**



10 Pieces 1/2" mm

### 1/2" IMPACT SOCKET CLIP RAIL SET ANSI

- ANSI standard design for use with power tools with a ball bearing socket retainer
- Chrome molybdenum for use with power tools
- Supplied on a clip rail for storage as a set

Clip rail (Length: 290mm), 1/2" Drive socket clips x10

Impact 6 point sockets: 

○ Reg mm: 10 11 12 13 14  
17 19 21 22 24

Item ID: **9121**



12 Pieces 1/2" mm

### 1/2" STUBBY IMPACT SOCKET CLIP RAIL SET DIN

- Short reach for use in confined spaces
- DIN standard design for use with a retaining pin and ring
- Chrome molybdenum for use with power tools
- Black phosphate finish for easy identification as an impact socket accessory
- Ring and pin fixing hole on the female end to secure the socket to the air gun
- Designed and manufactured to DIN3129

Clip rail (Length: 290mm), 1/2" Drive socket clips x10

Impact 6 point sockets: 

○ Deep mm: 10 11 12 13 14 15  
16 17 19 21 22 24

Item ID: **9207S12**



**TT**  
SERIES

Impact Sets available

**MODULAR TOOL CONTROL SYSTEM**



**PAGE 63**

**FOAM**  
SERIES

Impact Sets available

**MODULAR TOOL CONTROL SYSTEM**



**PAGE 129**

# SOCKETS & ACCESSORIES

Get the job done, fast

The socket range includes drives from ¼" to 1" and includes six-point sockets and twelve-point sockets, metric and imperial sizes as well as a wide range of bit sockets including Hex, TX, TX-E, and TPX.



## 72 TEETH RATCHETS

72 teeth ratchets give a working arc of just 5 degrees, resulting in outstanding accessibility in confined areas

The ratchet head is sealed, which prevents dirt and dust from entering the mechanism – giving a longer life and trouble-free use

More teeth are engaged simultaneously – which means you can use greater force without the mechanism failing

The rotation disc, to change direction, has a good grip for oily fingers or gloves

Ergonomic bi-material grip for maximum comfort while using

## FRP RATCHETS

Quick release mechanism that makes it possible to release sockets and accessories with one hand

Ratchet mechanism with 45 teeth (8 degree intervals)

Lever for quick reversing between left and right-hand action

All individual parts and service kits are available and easy to fit

Fibre ratchet handle with steel reinforcement that is lighter than standard ratchet handles, but just as strong

Bi-material handle with an ergonomic design that makes the ratchet very comfortable to use, especially in cold environments







**1/4" MINI BITS RATCHET**

1/4"

- 1/4" hex drive reversible bits ratchet
- Overall length 90mm making it very compact and easy to keep in the pocket
- Flip reverse mechanism for quickly changing between tightening and loosening
- Chrome vanadium satin finish drop forged steel
- For use with 1/4" drive hex bits
- 8mm double hexagon ring spanner on the other end

Item ID: **1400B**



**1/4" MINI PALM RATCHET**

1/4"

- Handle designed for use in the palm of the hand
- Use with an extension bar to create a ratcheting T bar
- For use in confined spaces
- Twist reverse for quickly and easily changing between tightening and loosening

Item ID: **1400M**



**1/4" RATCHET HEAD HEX**

1/4"

- Fine tooth mini ratchet head
- Designed for use together with any 1/4" hex drive bit holder
- 1/4" square drive for use with sockets and accessories
- 1/4" hexagon drive for use with screwdriver bits and accessories
- 72 teeth for use in confined spaces
- Flip reverse for quickly and easily changing between tightening and loosening
- Designed and manufactured to DIN3122D

Item ID: **RHA14**



**1/4" MINI RATCHET 72 TEETH**

1/4"

- Fine tooth mini ratchet
- Shorter handle for easier use in confined spaces
- 72 teeth giving 5 degree increments between clicks
- Twist reverse for quickly and easily changing between tightening and loosening
- Slim design together with a bi-material grip for extra comfort
- Designed and manufactured to DIN3122D

Item ID: **1400-72MN**



**RATCHET 72 TEETH**

- Fine tooth ratchet
- 72 teeth giving 5 degree increments between clicks
- Twist reverse for quickly and easily changing between tightening and loosening
- Slim design together with a bi-material grip for extra comfort
- Designed and manufactured to DIN3122D

**1/4" GEARLESS RATCHET**

1/4"

- Gearless palm ratchet
- 1/4" square drive for use with sockets and accessories
- 1/4" hexagon drive for use with screwdriver bits and accessories
- Handle designed for easy rotation with the fingers
- Use with an extension bar to create a ratcheting T bar
- Gearless mechanism for use in confined spaces
- Twist reverse for quickly and easily changing between tightening and loosening

Item ID: **PM14**



ITEM ID:	Drive	Reverse	Quick Release	No. of Teeth	Length mm	Weight g
1400-72N	1/4"	Twist		72	150	110
3800-72N	3/8"	Twist	Y	72	203	265
1200-72N	1/2"	Twist	Y	72	250	400



### RATCHET 72 TEETH FLEXIBLE HEAD

- Fine tooth stubby flex head ratchet
- Shorter handle for easier use in confined spaces
- Flexible ratchet head with locking mechanism for use at different angles
- 72 teeth giving 5 degree increments between clicks
- Twist reverse for quickly and easily changing between tightening and loosening
- Slim design together with a bi-material grip for extra comfort

ITEM ID:	Drive	Reverse	Quick Release	No. of Teeth	Length mm	Weight g
1400-72SN	1/4"	Twist		72	121	114
3800-72SN	3/8"	Twist	Y	72	178	270
1200-72SN	1/2"	Twist	Y	72	190	395



### RATCHET FRP 45 TEETH

- Fibre reinforced handle with three metal plates for added strength
- 45 teeth giving 8 degree increments between clicks
- Flip reverse for quickly and easily changing between tightening and loosening
- Quick release for easier changing between different sockets and accessories
- Bi-material grip for extra comfort
- Designed and manufactured to DIN3122D

ITEM ID:	Drive	Reverse	Quick Release	No. of Teeth	Length mm	Weight g
1400FRP	1/4"	Flip	Y	45	150	96
3800FRP	3/8"	Flip	Y	45	203	227
1200FRP	1/2"	Flip	Y	45	255	358



### 1/2" LONG RATCHET FLEXIBLE HEAD

1/2"

- 400mm long handle for added torque when needed
- Flexible ratchet head with locking mechanism for use at different angles
- 45 teeth giving 8 degree increments between clicks
- Twist reverse for quickly and easily changing between tightening and loosening
- Quick release for easier changing between different sockets and accessories
- Bi-material grip for extra comfort

Item ID: **1200F**

### 1/2" RATCHET LONG ARM

1/2"

- 400mm long handle for added torque when needed
- 45 teeth giving 8 degree increments between clicks
- Twist reverse for quickly and easily changing between tightening and loosening
- Quick release for easier changing between different sockets and accessories
- Bi-material grip for extra comfort

Item ID: **1200L**

### EXTENDABLE RATCHETS

- 3/8" drive
- Extendable handle in 5 steps, 250-356 mm
- 41 teeth
- Twist reverse
- Quick release
- Ball lock socket retainer
- Design and manufactured according to DIN3122D
- Prepared for Tool securing

ITEM ID:	Drive	Reverse	Quick Release	No. of Teeth	Length mm	Weight g
3800-41E	3/8"	Twist	Y	41	250-356	499
1200-45E	1/2"	Twist	Y	45	356-508	995
M340072E	3/4"	Twist	Y	72	545-860	3382





**RATCHET HEAVY DUTY**

- Twist reverse for quickly and easily changing between tightening and loosening
- Quick release for easier changing between different sockets and accessories
- Rubber grip on the handle for a better grip particularly in wet or oily conditions
- Ball bearing socket retainer on the square drive to securely grip the socket

ITEM ID:	Drive	Reverse	Quick Release	No. of Teeth	Length mm	Weight g
M3400-72	3/4"	Twist	Y	72	505	2000
M1100-72	1"	Twist	Y	72	800	4060



**1" RATCHET**

- Detachable head to enable the bar to be used as a power bar
- 24 teeth giving 15 degree increments between clicks
- Flip reverse for quickly and easily changing between tightening and loosening
- Quick release for easier changing of sockets
- Ball bearing socket retainer on the square drive
- Knurled grip area on the handle for a better grip particularly in wet or oily conditions
- Designed and manufactured to DIN3122D

ITEM ID:	Drive	Reverse	Quick Release	No. of Teeth	Length mm	Weight g
M1100	1"	Flip	Y	24	665	4410



**1" RATCHET HEAD**

- For use with the 1" power bar (M110020)
- 24 teeth giving 15 degree increments between clicks
- Flip reverse for quickly and easily changing between tightening and loosening
- Quick release for easier changing between different sockets and accessories
- Ball bearing socket retainer on the square drive to securely grip the socket
- Designed and manufactured to DIN3122D

ITEM ID:	Drive	Reverse	Quick Release	No. of Teeth	Length mm	Weight g
M110010	1"	Flip	Y	24	165	1740



1"

**1" POWER BAR**

- For use as a ratchet handle together with the M110010 ratchet head
- Can be used to create a power bar or T bar together with the M110030 T bar adaptor
- Chrome vanadium
- Satin finish for a better grip when handling sockets
- Ball bearing socket retainer on the square drive to securely grip the socket
- Knurled grip area on the handle for a better grip particularly in wet or oily conditions

Item ID: **M110020**

**RATCHET SERVICE KITS**

- Full service kit for ratchets
- Includes a set of replacement parts for the ratchet mechanism
- Simple and quick to fit so the ratchet does not need to be sent away
- Reduces the amount of time that the ratchet is out of use

ITEM ID:	Drive	Service Kit For:
1400-72NRK	1/4"	1400-72N & 1400-72SN
1400FRPRK	1/4"	1400FRP
3800-72NRK	3/8"	3800-72N & 3800-72SN
3800FRPRK	3/8"	3800FRP
3800-41ERK	3/8"	3800-41E
1200-72NRK	1/2"	1200-72N & 1200-72SN
1200FRPRK	1/2"	1200FRP
1200FRK	1/2"	1200F & 1200L
M3400-72RK	3/4"	M3400-72
M1100-72RK	1"	M1100-72
M1100RK	1"	M1100 & M110010



1/4"

**FLEXIBLE SOCKET DRIVER**

- Flexible spring wound shaft for easier access in confined spaces
- Overall length 275mm
- For use with 1/4" drive sockets and accessories
- Ergonomically designed bi-material handle for easy use with higher torque and faster speed
- Hole in the handle for hanging or for use as a T handle for extra torque or with a fall protection wire if needed

Item ID: **MD514N**



**SPINNER HANDLE**

- Ergonomically designed bi-material handle for easy use particularly in wet or oily conditions
- Chrome vanadium
- Satin finish for a better grip when handling sockets
- Ball bearing recess on the female end to grip the ratchet or power bar
- Ball bearing socket retainer on the male end to securely grip the socket
- Designed and manufactured to DIN3122E
- Supplied with a metal socket clip for use with a socket rail

ITEM ID:	Drive	Overall Length mm
M140015-C	1/4"	150
M380015-C	3/8"	250



1/4"

**EXTRA LONG FLEXIBLE SOCKET DRIVER**

- Long reach flexible socket driver
- Flexible spring wound shaft for easier access in confined spaces
- Protected by a plastic sleeve to avoid pinching
- Overall length 555mm
- For use with 1/4" drive sockets and accessories
- Ergonomically designed bi-material handle for easy use with higher torque and faster speed
- Hole in the handle for hanging or for use as a T handle for extra torque or with a fall protection wire if needed

Item ID: **MD514L**



3/8"

**ROTATING SPINNER HANDLE**

- 10" (250mm) spinner handle and extension bar
- Rotating handle end creates an easy to use grip especially when using together with a ratchet
- Ergonomically designed bi-material handle for easy use particularly in wet or oily conditions
- 3/8" drive female intake in the handle to enable use as an extension bar
- Chrome vanadium
- Satin finish for a better grip when handling sockets
- Ball bearing recess on the female end to grip the ratchet or power bar
- Ball bearing socket retainer on the male end to securely grip the socket
- Designed and manufactured to DIN3122E
- Supplied with a metal socket clip for use with a socket rail

Item ID: **PT3810R**



**SPINNER HANDLES** with female intake in 1/4" & 3/8" drive are available. The handle can be used with a ratchet as an extension bar





**FLEX HANDLE OFFSET**

- Designed for extra torque to use with stubborn nuts and bolts
- Ball bearing socket retainer on the square drive for secure grip
- Chrome vanadium
- Satin finish for a better grip when handling sockets
- Ergonomically designed bi-material handle for easy use particularly in wet or oily conditions
- Designed and manufactured to DIN3122F

ITEM ID:	Drive	Length			Weight g
		AF	mm		
M380010A-C	3/8"	10"	250	Offset Shaft	375
M120010-C	1/2"	10"	265		492
1201	1/2"	17"	450		894
1201A	1/2"	24"	600		1198
M340070-C	3/4"	19"	480		1880
M340070S-C	3/4"	19"	480	Safety Locking	1880
M110070	1"	25"	650		3550

**FLEX HANDLE SERVICE KITS**

- Includes a set of replacement parts for the square drive
- Simple to fit so the flex handle does not need to be sent away
- Reduces the time that the flex handle is out of use

ITEM ID:	Drive	Service Kit For:
1201ARK	1/2"	1201 & 1201A
M120010RK	1/2"	M120010RK
M340070RK	3/4"	M340070-C
M340070SRK	3/4"	M340070S-C
M110070RK	1"	M110070



**SPEED BRACE**

- Designed to transport fastenings more quickly
- Ball bearing socket retainer on the square drive for secure grip
- Chrome vanadium
- Satin finish for a better grip when handling sockets
- Knurled grip area on the handle for a better grip particularly in wet or oily conditions

ITEM ID:	Drive	Length mm	Weight g
M380011-C	3/8"	380	310
M120011-C	1/2"	420	585



**WOBBLE EXTENSION BARS**

- Made from chrome vanadium steel
- Ball point end allows the socket to be turned even at an angle
- Ideal for use in confined spaces
- Satin finish for a better grip when handling sockets
- Ball bearing recess on the female end to grip the ratchet
- Ball bearing socket retainer on the male end to securely grip the socket
- Supplied with a metal socket clip for use with a socket rail

ITEM ID:	Drive	Length		Safety Locking Screw	Weight g
		AF	mm		
M380020W-C	3/8"	3"	75	Y	63
M380021W-C	3/8"	6"	150	N	145
M380022W-C	3/8"	10"	255	Y	234
M120020W-C	1/2"	3"	75	Y	105
M120021W-C	1/2"	6"	150	N	240
M120022W-C	1/2"	10"	255	N	420



### EXTENSION BARS

- Made from chrome vanadium steel
- Ball bearing recess on the female end to grip the ratchet
- Ball bearing socket retainer on the male end to securely grip the socket
- Designed and manufactured to DIN3123B
- Supplied with a metal socket clip for use with a socket rail

ITEM ID:	Drive	Length		Safety Lock	Weight g
		AF	mm		
M140020-C	1/4"	2"	50	N	22
M140023-C	1/4"	3"	75	N	35
M140021-C	1/4"	4"	100	N	46
M140022-C	1/4"	6"	150	N	65
M140038-C	1/4"	6"	150	N	26
M140024-C	1/4"	12"	305	N	126
M380020-C	3/8"	3"	75	N	75
M380023-C	3/8"	5"	125	N	120
M380021-C	3/8"	6"	150	N	145
M380022-C	3/8"	10"	254	N	420
M380024-C	3/8"	20"	500	N	506
M120020-C	1/2"	2 1/2"	63.5	N	105
M120021-C	1/2"	5"	125	N	222
M120023-C	1/2"	6"	150	N	240
M120022-C	1/2"	10"	255	N	420
M120024-C	1/2"	20"	500	N	855
M340020-C	3/4"	4"	100	N	400
M340020S-C	3/4"	4"	100	Y	450
M340021-C	3/4"	8"	200	N	700
M340021S-C	3/4"	8"	200	Y	750
M340022-C	3/4"	16"	400	N	1400
M340022S-C	3/4"	16"	400	Y	1400
M110040	1"	8"	200	N	1350
M110050	1"	16"	400	N	2400



### UNIVERSAL JOINT

- Head rotates through 180° for use at different angles
- Ideal for use in confined spaces
- Chrome vanadium
- Satin finish for a better grip when handling sockets
- Ball bearing recess on the female end to grip the ratchet
- Ball bearing socket retainer on the male end to securely grip the socket
- Designed and manufactured to DIN3123C
- Supplied with a metal socket clip for use with a socket rail

ITEM ID:	Drive	Length mm	Safety	Weight g
			Locking Screw	
M140030-C	1/4"	33	Y	23
M380030-C	3/8"	50	Y	65
M120030-C	1/2"	69	Y	165
M340030-C	3/4"	108	N	570



1/2"

### 1/2" FLEX HEAD ADAPTOR

- Use to convert an extension bar into a flex handle
- Head rotates through 180° for use at different angles
- Designed for extra torque to use with stubborn nuts and bolts
- Can also be used straight to transport fastenings more quickly
- Chrome vanadium
- Satin finish for a better grip when handling the adaptor
- Supplied with a metal socket clip for use with a socket rail

Item ID: **M120080-C**



**ADAPTORS**

- Made from chrome vanadium steel
- Satin finish for a better grip when handling sockets
- Ball bearing socket retainer on the male end to securely grip the socket
- Supplied with a metal socket clip for use with a socket rail

ITEM ID:	Drive	T-Drive Facility	Adaptor	Length mm	Weight g
M140036-C	1/4"	N	1/4"F - 3/8"M	25	20
M140037	1/4"	N	1/4"M - 1/4"Hex	25	7
M140039	1/4"	N	1/4"M - 1/4"Hex	30	10
M380035-C	3/8"	Y	3/8"F - 1/4"M	25.4	20
M380036-C	3/8"	Y	3/8"F - 1/2"M	36	45
M380037	3/8"	N	1/4"Hex - 3/8"M	32	14
M120036-C	1/2"	Y	1/2"F - 3/8"M	39.5	55
M120037-C	1/2"	N	1/2"F - 3/4"M	39.5	55
M340085-C	3/4"	N	3/4"F - 1"M	62	370
M340086-C	3/4"	Y	3/4"F - 1/2"M	40	164
M110030	1"	Y	1" T-Bar Adaptor	82	620



**COUPLER ADAPTORS**

- Coupler adaptors for holding various bits
- Chrome vanadium
- Satin finish for a better grip when handling the adaptor
- Retaining spring to hold the bit in place
- Designed and manufactured to DIN 3120
- Supplied with a metal socket clip for use with a socket rail

ITEM ID:	Drive	Coupler For	Length mm	Weight g
M140060-C	1/4"	1/4" Hex Bits	25	20
M380060-C	3/8"	1/4" Hex Bits	28	32
M380061-C	3/8"	10mm Hex Bits	28	32
M120060-C	1/2"	5/16" Hex Bits	38	88
M120061-C	1/2"	10mm Hex Bits	38	56
M120062-C	1/2"	12mm Hex Bits	38	62
M120063-C	1/2"	1/4" Hex Bits	25	88



**INSERT ADAPTORS**

- Quickly steps up from one drive to the next
- Magnets retain the socket in place
- Ideal for use where space is limited or where a regular adaptor is not suitable

ITEM ID:	Drive	Coupler For	Length mm	Weight g
M140036M	1/4"	1/4"F - 3/8"M	28	18
M380036M	3/8"	3/8"F - 1/2"M	30	30
M120037M	1/2"	1/2"F - 3/4"M	45	86
M340085M	3/4"	3/4"F - 1"M	54	130



**STEP UP ADAPTOR SET 4 PIECES**

4 Pieces

- 4 piece insert adaptor set
- Enables the use of smaller drive ratchets and accessories with larger sockets, etc.
- Magnets retain the socket in place
- Ideal for use where space is limited or where a regular adaptor is not suitable

Step Up Adaptors:	1/4"F x 3/8"M	3/8" x 1/2"M
	1/2"F x 3/4"F	3/4"M - 1"F

Item ID: **MX04**



### SLIDING T BARS

- Use to create a T bar for fast transporting of the fastening
- Chrome vanadium
- Satin finish for a better grip when handling sockets
- Ball bearing socket retainer on the male end for secure grip
- Designed and manufactured to DIN3122A

ITEM ID:	Drive	Safety Lock	Length mm	Weight g
M140050-C	1/4"	N	106	40
M380050-C	3/8"	N	170	122
M120050-C	1/2"	N	243	300
M340050-C	3/4"	N	450	450
M340050S-C	3/4"	Y	450	450



### T-BAR HANDLE

- T bar handle grip
- Plastic handle for use with T bars
- Use with TengTools extra long extension bars and 3/8"F x 1/4" M T bar adaptors
- Creates a much more comfortable grip

Item ID: **T-HD**



## TT SERIES

Socket Sets available

### MODULAR TOOL CONTROL SYSTEM



**PAGE 55**

## FOAM SERIES

Socket Sets available

### MODULAR TOOL CONTROL SYSTEM



**PAGE 122**

1/4" DRIVE SOCKETS

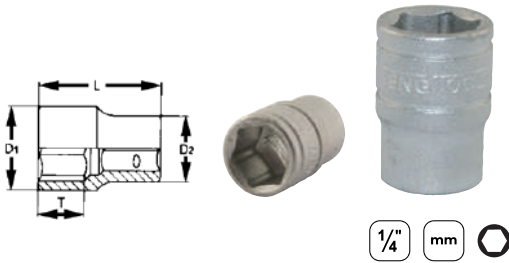

1/4" SOCKET 6 PT METRIC

- 6 point single hexagon socket for a better grip
- Chrome vanadium
- Satin finish for a better grip when handling the socket
- Ball bearing recess on the female end to grip the ratchet
- Designed and manufactured to DIN3120/3124 and ISO2725
- Supplied with a metal socket clip for use with a socket rail

ITEM ID:	Size mm	L mm	Tmin mm	D1 mm	D2 mm	Weight g
M140504-C	4	25	3.6	6.9	12	10
M1405045-C	4.5	25	3.6	7.5	12	12
M140505-C	5	25	4.2	8.1	12	12
M1405055-C	5.5	25	4.2	8.8	12	12
M140506-C	6	25	4.8	9.4	12	12
M140507-C	7	25	4	10.9	12	13
M140508-C	8	25	4	12	11.4	13
M140509-C	9	25	4.5	13.2	11.9	13
M140510-C	10	25	6	14.7	12.9	17
M140511-C	11	25	6	16	12.9	20
M140512-C	12	25	7	16.9	13.4	21
M140513-C	13	25	7.5	17.7	13.9	24

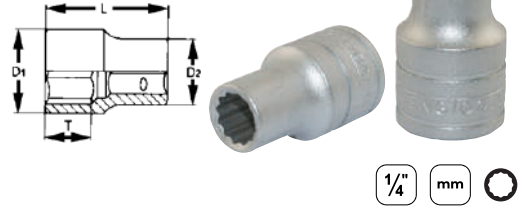

1/4" SOCKET 12 PT METRIC

- 12 point bi-hexagon socket for a better grip
- Chrome vanadium
- Satin finish for a better grip when handling the socket
- Ball bearing recess on the female end to grip the ratchet
- Designed and manufactured to DIN3120/3124 and ISO2725
- Supplied with a metal socket clip for use with a socket rail

ITEM ID:	Size mm	L mm	Tmin mm	D1 mm	D2 mm	Weight g
M14050412-C	4	25	3.6	6.9	12	10
M14050512-C	5	25	4.2	8.1	12	12
M140505512-C	5.5	25	4.2	8.8	12	12
M14050612-C	6	25	4.8	9.4	12	12
M14050712-C	7	25	4	10.9	12	13
M14050812-C	8	25	4	12	11.4	13
M14050912-C	9	25	4.5	13.2	11.9	13
M14051012-C	10	25	6	14.7	12.9	17
M14051112-C	11	25	6	16	12.9	20
M14051212-C	12	25	7	16.9	13.4	21
M14051312-C	13	25	7.5	17.7	13.9	24

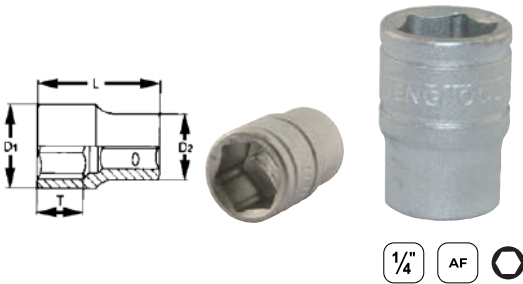

**1/4" SOCKET 6 PT AF**

- 6 point single hexagon socket for a better grip
- Chrome vanadium
- Satin finish for a better grip when handling the socket
- Ball bearing recess on the female end to grip the ratchet
- Designed and manufactured to DIN3120/3124 and ISO2725
- Supplied with a metal socket clip for use with a socket rail

ITEM ID:	Size AF	L mm	Tmin mm	D1 mm	D2 mm	Weight g
M140106-C	3/16"	25	3.6	8	12	12
M140107-C	7/32"	25	4.2	8.8	12	12
M140108-C	1/4"	25	4.8	10	12	12
M140109-C	9/32"	25	4	12	10.9	13
M140110-C	5/16"	25	4	12	11.4	13
M140111-C	11/32"	25	4.5	13.2	11.9	18
M140112-C	3/8"	25	4.5	14.4	12.4	19
M140114-C	7/16"	25	6	16	12.9	22
M140116-C	1/2"	25	7.2	17.7	13.9	28

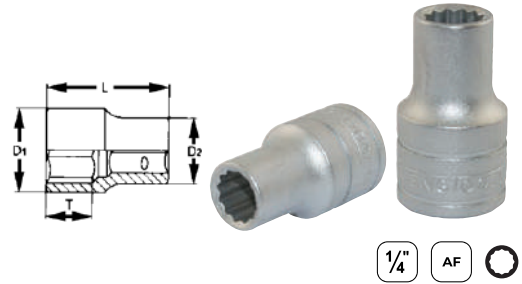

**1/4" SOCKET 12 PT AF**

- 12 point bi-hexagon socket for a better grip
- Chrome vanadium
- Satin finish for a better grip when handling the socket
- Ball bearing recess on the female end to grip the ratchet
- Designed and manufactured to DIN3120/3124 and ISO2725
- Supplied with a metal socket clip for use with a socket rail

ITEM ID:	Size AF	L mm	Tmin mm	D1 mm	D2 mm	Weight g
M14010612-C	3/16"	25	3.6	8	12	12
M14010712-C	7/32"	25	4.2	8.8	12	12
M14010812-C	1/4"	25	4.8	10	12	12
M14010912-C	9/32"	25	4	12	10.9	13
M14011012-C	5/16"	25	4	12	11.4	13
M14011112-C	11/32"	25	4.5	13.2	11.9	18
M14011212-C	3/8"	25	4.5	14.4	12.4	19
M14011412-C	7/16"	25	6	16	12.9	22
M14011612-C	1/2"	25	7.2	17.7	13.9	28



**6-point sockets v 12-point sockets**

12-point sockets, common in Aircraft Maintenance and Engineering, are ideal for use in confined space and for fast lightweight work. 6-point sockets are ideal for when extra torque needs to be applied. They are designed to contact the head of a fastener well away from the corners, this dramatically reduces the likelihood of slippage and rounding over of the corners.





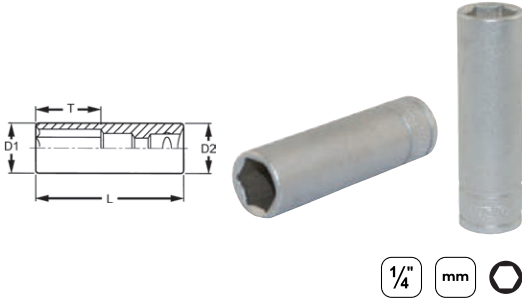

1/4" mm

**1/4" DEEP SOCKET 6 PT METRIC**

- 6 point single hexagon socket for a better grip
- Long sockets for extra reach
- Chrome vanadium
- Satin finish for a better grip when handling the socket
- Ball bearing recess on the female end to grip the ratchet
- Designed and manufactured to DIN3120/3124 and ISO2725
- Supplied with a metal socket clip for use with a socket rail

ITEM ID:	Size mm	L mm	Tmin mm	D1 mm	D2 mm	Weight g
M140604-C	4	49.5	5	6.9	11.8	23
M140605-C	5	49.5	5.5	8	11.8	25
M1406055-C	5.5	49.5	5.5	8.8	11.8	26
M140606-C	6	49.5	6.5	9.4	11.8	26
M140607-C	7	49.5	10.5	10.9	11.8	27
M140608-C	8	49.5	10.5	11.8	11.8	30
M140609-C	9	49.5	11.5	12.8	12.8	37
M140610-C	10	49.5	13	14.5	14.5	38
M140611-C	11	49.5	14	15.6	15.6	43
M140612-C	12	49.5	15	16.6	16.6	46
M140613-C	13	49.5	17	17.6	17.6	48

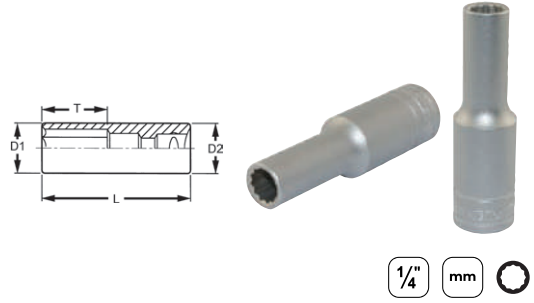

1/4" mm

**1/4" DEEP SOCKET 12 PT METRIC**

- 12 point bi-hexagon socket for a better grip
- Long sockets for extra reach
- Chrome vanadium
- Satin finish for a better grip when handling the socket
- Ball bearing recess on the female end to grip the ratchet
- Designed and manufactured to DIN3120/3124 and ISO2725
- Supplied with a metal socket clip for use with a socket rail

ITEM ID:	Size mm	L mm	Tmin mm	D1 mm	D2 mm	Weight g
M14060612-C	6	49.5	6.5	9.4	11.8	26
M14060712-C	7	49.5	10.5	10.9	11.8	27
M14060812-C	8	49.5	10.5	11.8	11.8	30
M14060912-C	9	49.5	11.5	12.8	12.8	37
M14061012-C	10	49.5	13	14.5	14.5	38
M14061112-C	11	49.5	14	15.6	15.6	43
M14061212-C	12	49.5	15	16.6	16.6	46
M14061312-C	13	49.5	17	17.6	17.6	48



Size clearly etched on the side of every socket



Made from extra strong chrome vanadium steel

Easily identify between metric & AF sockets as 2 rings are etched on the side of each metric socket and 1 ring on each AF socket

AF

mm

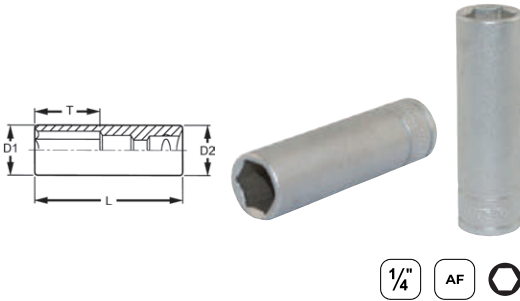

**1/4" DEEP SOCKET 6 PT AF**

- 6 point single hexagon socket for a better grip
- Long sockets for extra reach
- Chrome vanadium
- Satin finish for a better grip when handling the socket
- Ball bearing recess on the female end to grip the ratchet
- Designed and manufactured to DIN3120/3124 and ISO2725
- Supplied with a metal socket clip for use with a socket rail

ITEM ID:	Size AF	L mm	Tmin mm	D1 mm	D2 mm	Weight g
M140206-C	3/16"	49.5	5	8	11.8	24
M140207-C	7/32"	49.5	5.5	9	11.8	26
M140208-C	1/4"	49.5	6.5	10	11.8	27
M140209-C	9/32"	49.5	10.5	11	11.8	26
M140210-C	5/16"	49.5	10.5	11.8	11.8	30
M140211-C	11/32"	49.5	11.5	12.8	11.8	34
M140212-C	3/8"	49.5	12.5	14.5	14.5	37
M140214-C	7/16"	49.5	14.5	15.6	15.6	44
M140216-C	1/2"	49.5	16.5	17.6	17.6	48

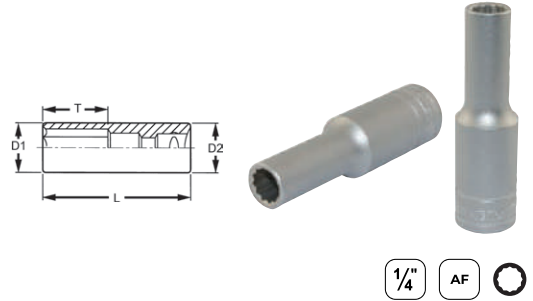

**1/4" DEEP SOCKET 12 PT AF**

- 12 point bi-hexagon socket for a better grip
- Long sockets for extra reach
- Chrome vanadium
- Satin finish for a better grip when handling the socket
- Ball bearing recess on the female end to grip the ratchet
- Designed and manufactured to DIN3120/3124 and ISO2725
- Supplied with a metal socket clip for use with a socket rail

ITEM ID:	Size AF	L mm	Tmin mm	D1 mm	D2 mm	Weight g
M14020612-C	3/16"	49.5	5	8	11.8	24
M14020712-C	7/32"	49.5	5.5	9	11.8	26
M14020812-C	1/4"	49.5	6.5	10	11.8	27
M14020912-C	9/32"	49.5	10.5	11	11.8	26
M14021012-C	5/16"	49.5	10.5	11.8	11.8	30
M14021112-C	11/32"	49.5	11.5	12.8	11.8	34
M14021212-C	3/8"	49.5	12.5	14.5	14.5	37
M14021412-C	7/16"	49.5	14.5	15.6	15.6	44
M14021612-C	1/2"	49.5	16.5	17.6	17.6	48



**TT**  
SERIES

Socket Sets available

**MODULAR TOOL CONTROL SYSTEM**



**PAGE 55**

**FOAM**  
SERIES

Socket Sets available

**MODULAR TOOL CONTROL SYSTEM**



**PAGE 122**

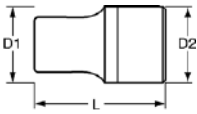

### 1/4" TX-E SOCKET

- Chrome vanadium
- Satin finish for a better grip when handling the socket
- Ball bearing recess on the female end to grip the ratchet
- Designed for use with protruding TX head screws
- Supplied with a metal socket clip for use with a socket rail

ITEM ID:	Size	L	Tmin	D1	D2	Weight g	
	mm	mm	mm	mm	mm		
M140704-C	E4	3.83	23.1	3.5	5.8	12	7
M140705-C	E5	4.75	24.8	4.5	6.8	12	8
M140706-C	E6	5.74	24.8	4.5	8	12	9
M140707-C	E7	6.22	24.8	5.6	9.4	12	10
M140708-C	E8	7.52	24.8	6	10.4	12	10

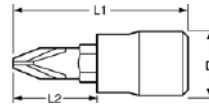

### 1/4" PH BIT SOCKET

- Chrome vanadium
- S2 steel bits pressed in to the socket
- Satin finish for a better grip when handling the socket
- Ball bearing recess on the female end to grip the ratchet
- Designed for use with Phillips type screws and fastenings
- Designed and manufactured to DIN 7422
- Supplied with a metal socket clip for use with a socket rail

ITEM ID:	Size	L1	L2	D	Weight g
	mm	mm	mm	mm	
M141300-C	PH0	32	15	12	13
M141301-C	PH1	32	15	12	13
M141302-C	PH2	32	15	12	13
M141303-C	PH3	32	15	12	13

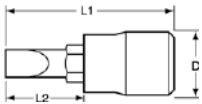

### 1/4" FLAT BIT SOCKET

- Chrome vanadium
- S2 steel bits pressed in to the socket
- Satin finish for a better grip when handling the socket
- Ball bearing recess on the female end to grip the ratchet
- Designed for use with slotted type screws and fastenings
- Designed and manufactured to DIN5264
- Supplied with a metal socket clip for use with a socket rail

ITEM ID:	Width	Thickness	L1	L2	D	Weight g
	mm	mm	mm	mm	mm	
M141404-C	4	0.8	32	15	12	13
M1414055-C	5.5	1.0	32	15	12	13
M141407-C	7	1.4	32	15	12	14

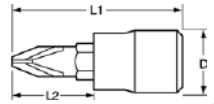

### 1/4" PZ BIT SOCKET

- Chrome vanadium
- S2 steel bits pressed in to the socket
- Satin finish for a better grip when handling the socket
- Ball bearing recess on the female end to grip the ratchet
- Designed for use with Pozidriv type screws and fastenings
- Supplied with a metal socket clip for use with a socket rail

ITEM ID:	Size	L1	L2	D	Weight g
	mm	mm	mm	mm	
M141601-C	PZ1	32	15	12	13
M141602-C	PZ2	32	15	12	13
M141603-C	PZ3	32	15	12	13

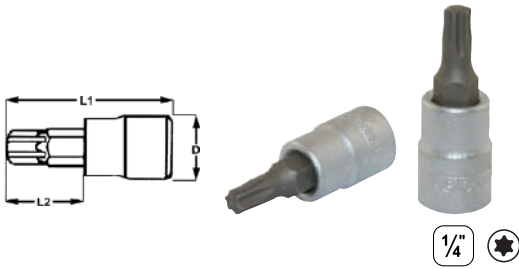

### 1/4" TX BIT SOCKET

- Chrome vanadium
- S2 steel bits pressed in to the socket
- Satin finish for a better grip when handling the socket
- Ball bearing recess on the female end to grip the ratchet
- Designed for use with fastenings with a TX hole
- Supplied with a metal socket clip for use with a socket rail

ITEM ID:	Size	Size mm	L1 mm	L2 mm	D mm	Weight g
M141210T-C	TX10	2.5	32	15	12	13
M141215T-C	TX15	3	32	15	12	13
M141220T-C	TX20	3.5	32	15	12	13
M141225T-C	TX25	4.5	32	15	12	13
M141227T-C	TX27	5	32	15	12	14
M141230T-C	TX30	5.5	32	15	12	14
M141240T-C	TX40	6.5	32	15	12	14



## 3/8" DRIVE SOCKETS

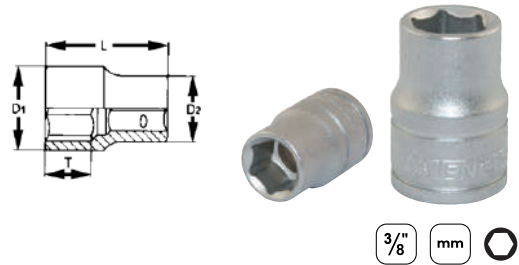

### 3/8" SOCKET 6 PT METRIC

- 6 point single hexagon socket for a better grip
- Chrome vanadium
- Satin finish for a better grip when handling the socket
- Ball bearing recess on the female end to grip the ratchet
- Designed and manufactured to DIN3120/3124 and ISO2725
- Supplied with a metal socket clip for use with a socket rail

ITEM ID:	Size mm	L mm	Tmin mm	D1 mm	D2 mm	Weight g
M380507-C	7	25.7	4	10.8	17.1	21
M380508-C	8	25.7	4.5	12	17.1	25
M380509-C	9	25.7	5	13.1	17.1	26
M380510-C	10	25.7	5	14.7	17.1	26
M380511-C	11	25.7	7	16	17.1	26
M380512-C	12	25.7	7	17.1	16.5	29
M380513-C	13	25.7	7	18.3	16.9	32
M380514-C	14	25.7	9	19.5	17.8	40
M380515-C	15	25.7	10	20.4	17.8	43
M380516-C	16	29	10	22.1	18.9	43
M380517-C	17	29	10	23.3	18.9	50
M380518-C	18	29	15.5	24.2	20	56
M380519-C	19	29	15.5	25.7	21	64
M380520-C	20	29	15.5	26.7	22	71
M380521-C	21	29	15.5	27.7	23	78
M380522-C	22	29	15.5	29.8	24	82

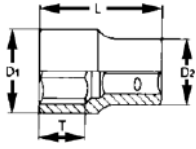

**3/8" SOCKET 12 PT METRIC**

- 12 point bi-hexagon socket for a better grip
- Chrome vanadium
- Satin finish for a better grip when handling the socket
- Ball bearing recess on the female end to grip the ratchet
- Designed and manufactured to DIN3120/3124 and ISO2725
- Supplied with a metal socket clip for use with a socket rail

ITEM ID:	Size mm	L mm	Tmin mm	D1 mm	D2 mm	Weight g
M38050812-C	8	25.7	4.5	12	17.1	25
M38050912-C	9	25.7	5	13.1	17.1	26
M38051012-C	10	25.7	5	14.7	17.1	26
M38051112-C	11	25.7	7	16	17.1	26
M38051212-C	12	25.7	7	17.1	16.5	29
M38051312-C	13	25.7	7	18.3	16.9	32
M38051412-C	14	25.7	9	19.5	17.8	40
M38051512-C	15	25.7	10	20.4	17.8	43
M38051612-C	16	29	10	22.1	18.9	43
M38051712-C	17	29	10	23.3	18.9	50
M38051812-C	18	29	15.5	24.2	20	56
M38051912-C	19	29	15.5	25.7	21	64
M38052212-C	22	29	15.5	29.8	24	82

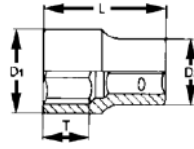

**3/8" SOCKET 6 PT AF**

- 6 point single hexagon socket for a better grip
- Chrome vanadium
- Satin finish for a better grip when handling the socket
- Ball bearing recess on the female end to grip the ratchet
- Designed and manufactured to DIN3120/3124 and ISO2725
- Supplied with a metal socket clip for use with a socket rail

ITEM ID:	Size AF	L mm	Tmin mm	D1 mm	D2 mm	Weight g
M380110-C	5/16"	25.7	4.5	11.7	17.1	23
M380112-C	3/8"	25.7	5	14.2	17.1	24
M380114-C	7/16"	25.7	7	16.3	17.1	26
M380116-C	1/2"	25.7	7	18.3	16.9	34
M380118-C	9/16"	25.7	9	19.5	17.8	38
M380120-C	5/8"	29	10	22.1	18.9	46
M380122-C	11/16"	29	10	24.2	20	50
M380124-C	3/4"	29	12	25.7	21	60
M380126-C	13/16"	29	13	27.7	23	68
M380128-C	7/8"	29	13	29.5	24	75

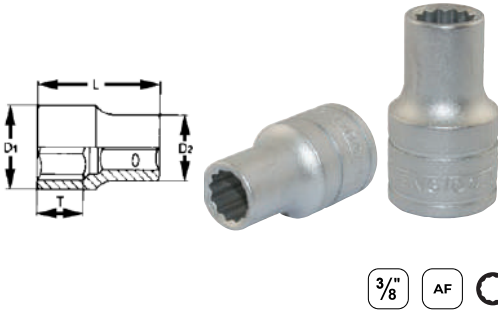

**3/8" SOCKET 12 PT AF**

- 12 point bi-hexagon socket for a better grip
- Chrome vanadium
- Satin finish for a better grip when handling the socket
- Ball bearing recess on the female end to grip the ratchet
- Designed and manufactured to DIN3120/3124 and ISO2725
- Supplied with a metal socket clip for use with a socket rail

ITEM ID:	Size AF	L mm	Tmin mm	D1 mm	D2 mm	Weight g
M38011212-C	3/8"	25.7	5	14.2	17.1	24
M38011412-C	7/16"	25.7	7	16.3	17.1	26
M38011612-C	1/2"	25.7	7	18.3	16.9	34
M38011812-C	9/16"	25.7	9	19.5	17.8	38
M38012012-C	5/8"	29	10	22.1	18.9	46
M38012212-C	11/16"	29	10	24.2	20	50
M38012412-C	3/4"	29	12	25.7	21	60

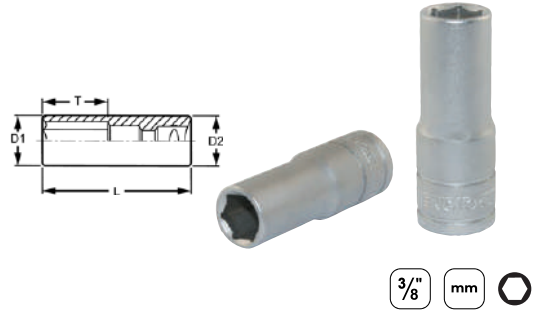

**3/8" DEEP SOCKET 6 PT METRIC**

- 6 point single hexagon socket for a better grip
- Long sockets for extra reach
- Chrome vanadium
- Satin finish for a better grip when handling the socket
- Ball bearing recess on the female end to grip the ratchet
- Designed and manufactured to DIN3120/3124 and ISO2725
- Supplied with a metal socket clip for use with a socket rail

ITEM ID:	Size mm	L mm	Tmin mm	D1 mm	D2 mm	Weight g
M380607-C	7	45.5	10	10.8	16.5	40
M380608-C	8	45.5	12	12	16.5	50
M380609-C	9	45.5	14	13.1	16.5	55
M380610-C	10	45.5	15	14.7	16.5	60
M380611-C	11	45.5	17	16.5	16.5	70
M380612-C	12	45.5	18	17.1	17.1	75
M380613-C	13	45.5	18	18.5	18.5	85
M380614-C	14	50	18	19.5	19.5	95
M380615-C	15	53	20	20.4	20.4	100
M380616-C	16	53	20	22	22	105
M380617-C	17	56	20	23.3	23.3	120
M380618-C	18	56	20	24.2	24.2	125
M380619-C	19	56	20	25.7	25.7	130
M380620-C	20	63.5	22	26.8	26.8	140
M380621-C	21	63.5	22	27.7	27.7	165
M380622-C	22	63.5	22	29.5	29.5	165



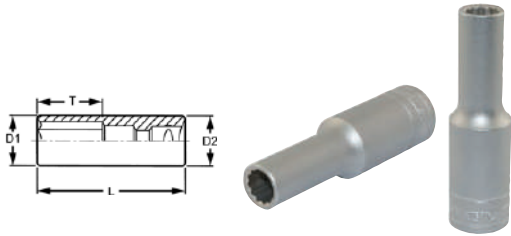

**3/8" DEEP SOCKET 12 PT METRIC**

- 12 point bi-hexagon socket for a better grip
- Long sockets for extra reach
- Chrome vanadium
- Satin finish for a better grip when handling the socket
- Ball bearing recess on the female end to grip the ratchet
- Designed and manufactured to DIN3120/3124 and ISO2725
- Supplied with a metal socket clip for use with a socket rail

ITEM ID:	Size mm	L mm	Tmin mm	D1 mm	D2 mm	Weight g
M38060712-C	7	45.5	10	10.8	16.5	40
M38060812-C	8	45.5	12	12	16.5	50
M38060912-C	9	45.5	14	13.1	16.5	55
M38061012-C	10	45.5	15	14.7	16.5	60
M38061112-C	11	45.5	17	16	16.5	70
M38061212-C	12	45.5	18	17.1	17.1	75
M38061312-C	13	45.5	18	18.5	18.5	85
M38061412-C	14	50	18	19.5	19.5	95
M38061512-C	15	53	20	20.4	20.4	100
M38061612-C	16	53	20	22	22	105
M38061712-C	17	56	20	23.3	23.3	120
M38061812-C	18	56	20	24.2	24.2	125
M38061912-C	19	56	20	25.7	25.7	130
M38062012-C	20	63.5	22	26.8	26.8	140
M38062112-C	21	63.5	22	27.7	27.7	165
M38062212-C	22	63.5	22	29.5	29.5	165

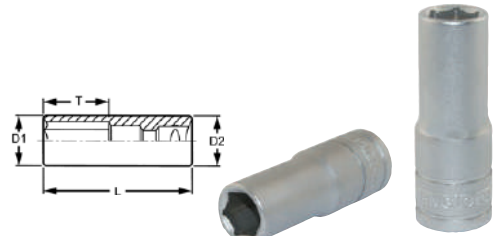

**3/8" DEEP SOCKET 6 PT AF**

- 6 point single hexagon socket for a better grip
- Long sockets for extra reach
- Chrome vanadium
- Satin finish for a better grip when handling the socket
- Ball bearing recess on the female end to grip the ratchet
- Designed and manufactured to DIN3120/3124 and ISO2725
- Supplied with a metal socket clip for use with a socket rail

ITEM ID:	Size AF	L mm	Tmin mm	D1 mm	D2 mm	Weight g
M380212-C	3/8"	45.5	15	14.2	16.5	43
M380214-C	7/16"	45.5	17	16.5	16.5	50
M380216-C	1/2"	45.5	18	18.5	18.5	62
M380218-C	9/16"	50	18	19.5	19.5	72
M380220-C	5/8"	53	20	22	22	97
M380222-C	11/16"	56	20	24.2	24.2	125
M380224-C	3/4"	56	22	25.7	25.7	130
M380226-C	13/16"	63.5	22	27.7	27.7	140
M380228-C	7/8"	63.5	22	29.5	29.5	165

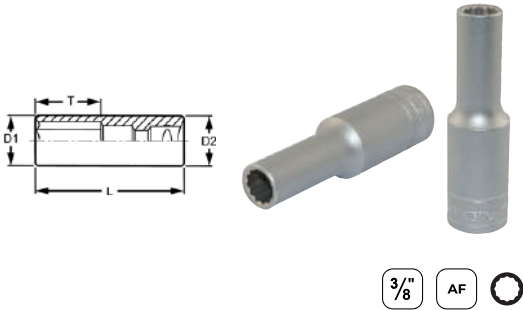

**3/8" DEEP SOCKET 12 PT AF**

- 12 point bi-hexagon socket for a better grip
- Long sockets for extra reach
- Chrome vanadium
- Satin finish for a better grip when handling the socket
- Ball bearing recess on the female end to grip the ratchet
- Designed and manufactured to DIN3120/3124 and ISO2725
- Supplied with a metal socket clip for use with a socket rail

ITEM ID:	Size AF	L mm	Tmin mm	D1 mm	D2 mm	Weight g
M38021212-C	3/8"	45.5	15	14.2	16.5	43
M38021412-C	7/16"	45.5	17	16.5	16.5	50
M38021612-C	1/2"	45.5	18	18.5	18.5	62
M38021812-C	9/16"	50	18	19.5	19.5	72
M38022012-C	5/8"	53	20	22	22	97
M38022212-C	11/16"	56	20	24.2	24.2	125
M38022412-C	3/4"	56	22	25.7	25.7	130

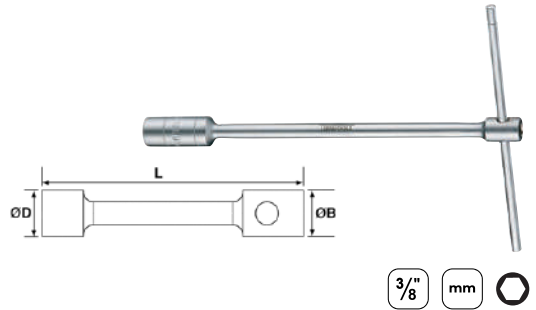

**3/8" T-BAR DEEP SOCKET 6 PT METRIC**

- 6 point single hexagon socket for a better grip
- Extra long sockets for extra reach
- Chrome vanadium
- Satin finish for a better grip when handling the socket
- Supplied with a sliding T bar for quicker tightening & loosening

ITEM ID:	Size mm	L mm	D mm	Weight g
TBSKT07	7	300	10	200
TBSKT08	8	300	10	200
TBSKT10	10	300	10	220
TBSKT12	12	300	10	240
TBSKT13	13	300	10	240
TBSKT14	14	300	10	240
TBSKT17	17	300	12	340
TBSKT19	19	300	12	360
T-HD01	200mm x 8mm Replacement bar for use with T-bar sockets			



**"Hip Grip"**

All sockets are produced according to TengTools "hip grip" system, which means the socket grips on the flat surfaces of the nut rather than on the corner. This system helps to prevent damage to nuts and bolts and makes it possible to grip nuts and bolts which already have damaged corners.

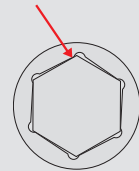





10 Pieces 3/8" mm

### 3/8" DEEP T BAR SOCKET SET 10 PIECES

- Extra long sockets for extra reach
- 6 point single hexagon socket for a better grip
- T bar with the TengTools T-HD handle for more comfortable use
- Chrome vanadium satin finish for a better grip
- Supplied with a sliding T bar for quicker tightening & loosening
- Supplied in a handy tool roll style wallet

2 Piece T-bar handle

300mm long deep sockets:

mm: 7 8 10 12 13 14 17 19

Item ID: **TBW10**

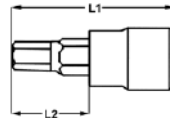

3/8" mm

### 3/8" HEX BIT SOCKET METRIC

- Chrome vanadium
- S2 steel bits pressed in to the socket
- Satin finish for a better grip when handling the socket
- Ball bearing recess on the female end to grip the ratchet
- Designed for use with fastenings with a hexagon hole
- Use with in-hex screws or grub screws
- Designed and manufactured to DIN7422
- Supplied with a metal socket clip for use with a socket rail

ITEM ID:	Size mm	L1 mm	L2 mm	D mm	Weight g
M381503-C	3	49.5	23	17.9	36
M381504-C	4	49.5	23	17.9	37
M381505-C	5	49.5	23	17.9	38
M3815055-C	5.5	49.5	23	17.9	38
M381506-C	6	49.5	23	17.9	38
M381507-C	7	49.5	23	17.9	38
M381508-C	8	49.5	23	17.9	40
M381510-C	10	49.5	23	17.9	52
M381512-C	12	49.5	23	22	56

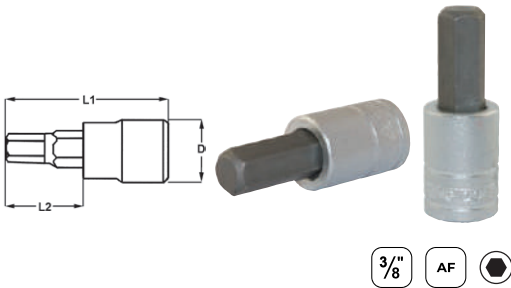

**3/8" HEX BIT SOCKET AF**

- Chrome vanadium
- S2 steel bits pressed in to the socket
- Satin finish for a better grip when handling the socket
- Ball bearing recess on the female end to grip the ratchet
- Designed for use with fastenings with a hexagon hole
- Use with in-hex screws or grub screws
- Designed and manufactured to DIN7422
- Supplied with a metal socket clip for use with a socket rail

ITEM ID:	Size AF	L1 mm	L2 mm	D mm	Weight g
M381103-C	3/32"	49.5	23	17.9	36
M381104-C	1/8"	49.5	23	17.9	36
M381105-C	5/32"	49.5	23	17.9	38
M381106-C	3/16"	49.5	23	17.9	38
M381107-C	7/32"	49.5	23	17.9	38
M381108-C	1/4"	49.5	23	17.9	40
M381110-C	5/16"	49.5	23	17.9	40
M381112-C	3/8"	49.5	23	17.9	42

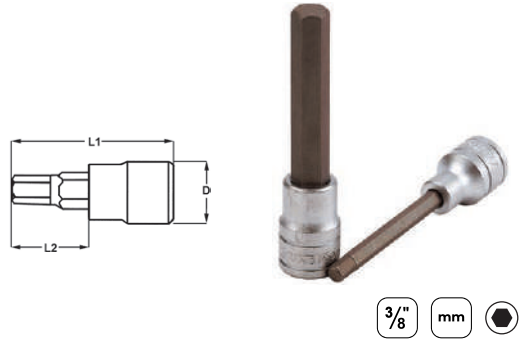

**3/8" HEX BIT SOCKET METRIC 100MM**

- Chrome vanadium
- S2 steel bits pressed into the socket
- Satin finish for a better grip when handling the socket
- Ball recess on the female end to grip the ratchet
- Designed for use with fastenings with a hexagon hole
- Use with in-hex screws or grub screws
- Designed and manufactured to DIN7422
- Supplied with a metal socket clip for use with a socket rail

ITEM ID:	Size mm	L1 mm	L2 mm	D mm	Weight g
M382503-C	3	100	74	17.9	48
M382504-C	4	100	74	17.9	50
M3825055-C	5	100	74	17.9	50
M382505-C	5.5	100	74	17.9	50
M382506-C	6	100	74	17.9	50
M382507-C	7	100	74	17.9	55
M382508-C	8	100	74	17.9	66
M382510-C	10	100	74	17.9	86
M382512-C	12	100	74	17.9	130



**TT SERIES** Socket Sets available

**MODULAR TOOL CONTROL SYSTEM**

**PAGE 55**

**FOAM SERIES** Socket Sets available

**MODULAR TOOL CONTROL SYSTEM**

**PAGE 122**

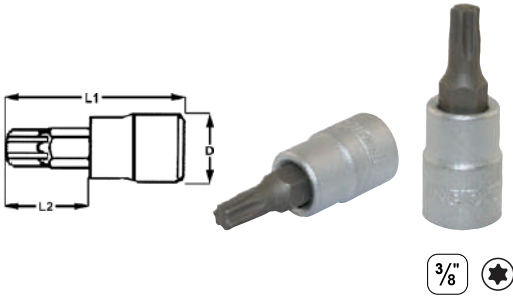

**3/8" TX BIT SOCKET**

- Chrome vanadium
- S2 steel bits pressed in to the socket
- Satin finish for a better grip when handling the socket
- Ball bearing recess on the female end to grip the ratchet
- Designed for use with fastenings with a TX hole
- Supplied with a metal socket clip for use with a socket rail

ITEM ID:	Size	Size mm	L1 mm	L2 mm	D mm	Weight g
M381210T-C	TX10	2.5	49.5	23	17.9	36
M381215T-C	TX15	3	49.5	23	17.9	36
M381220T-C	TX20	3.5	49.5	23	17.9	36
M381225T-C	TX25	4.5	49.5	23	17.9	36
M381227T-C	TX27	5	49.5	23	17.9	37
M381230T-C	TX30	5.5	49.5	23	17.9	37
M381240T-C	TX40	6.5	49.5	23	17.9	40
M381245T-C	TX45	7.5	49.5	23	17.9	45
M381250T-C	TX50	8.8	49.5	23	17.9	50

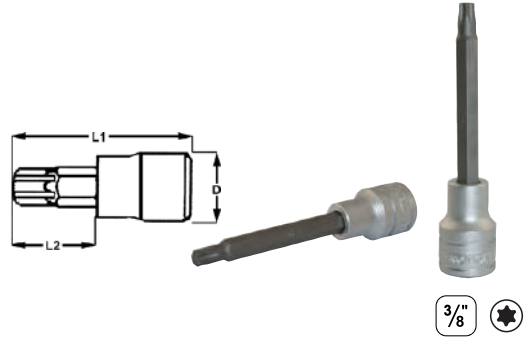

**3/8" TX BIT SOCKET 100MM**

- Chrome vanadium
- S2 steel bits pressed into the socket
- Satin finish for a better grip when handling the socket
- Ball recess on the female end to grip the ratchet
- Designed for use with fastenings with a TX hole
- Supplied with a metal socket clip for use with a socket rail

ITEM ID:	Size	Size mm	L1 mm	L2 mm	D mm	Weight g
M382210T-C	TX10	2.5	100	74	17.9	48
M382215T-C	TX15	3	100	74	17.9	48
M382220T-C	TX20	3.5	100	74	17.9	50
M382225T-C	TX25	4.5	100	74	17.9	50
M382227T-C	TX27	5	100	74	17.9	50
M382230T-C	TX30	5.5	100	74	17.9	50
M382240T-C	TX40	6.5	100	74	17.9	50
M382245T-C	TX45	7.5	100	74	17.9	65
M382250T-C	TX50	8.8	100	74	17.9	65



**Do's and Dont's of Socketry**

**DO'S**

- Use the right drive
- Use the correct socket size
- Check the thread direction
- Keep it clean and dry
- Use light oil on ratchet mechanisms

**DONT'S**

- Do not use with impact tools
- Do not use TPX on a TX fastenings
- Do not use poles to increase leverage

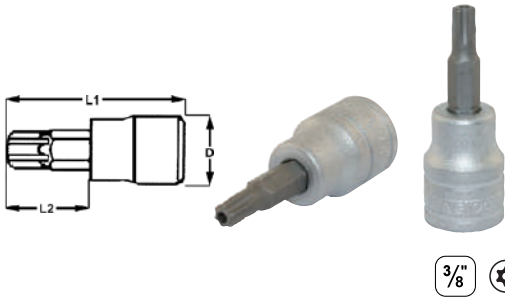

### 3/8" TPX BIT SOCKET

- Chrome vanadium
- S2 steel bits pressed in to the socket
- Satin finish for a better grip when handling the socket
- Ball bearing recess on the female end to grip the ratchet
- Designed for use with fastenings with a TX hole with a security pin
- Supplied with a metal socket clip for use with a socket rail

ITEM ID:	Size	Size mm	L1 mm	L2 mm	D mm	Weight g
M381210-C	TPX10	2.5	49.5	23	17.9	36
M381215-C	TPX15	3	49.5	23	17.9	36
M381220-C	TPX20	3.5	49.5	23	17.9	36
M381225-C	TPX25	4.5	49.5	23	17.9	36
M381227-C	TPX27	5	49.5	23	17.9	37
M381230-C	TPX30	5.5	49.5	23	17.9	37
M381240-C	TPX40	6.5	49.5	23	17.9	40
M381245-C	TPX45	7.5	49.5	23	17.9	45
M381250-C	TPX50	8.8	49.5	23	17.9	50

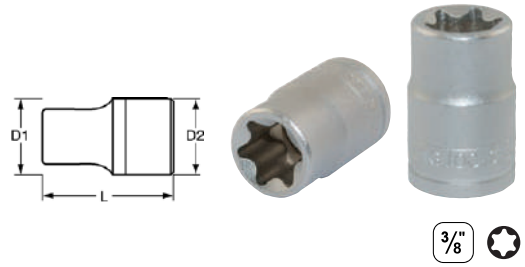

### 3/8" TX-E SOCKET

- Chrome vanadium
- Satin finish for a better grip when handling the socket
- Ball bearing recess on the female end to grip the ratchet
- Designed for use with protruding TX head screws
- Supplied with a metal socket clip for use with a socket rail

ITEM ID:	Size	Size mm	L mm	Tmin mm	D1 mm	D2 mm	Weight g
M380710-C	E10	9.42	28	7.2	13	17	25
M380712-C	E12	11.17	28	7.7	15	17	25
M380714-C	E14	12.9	28	9.6	16.3	18	30
M380716-C	E16	14.76	28	10.8	20	20	35
M380718-C	E18	16.7	28	12	22	22	40

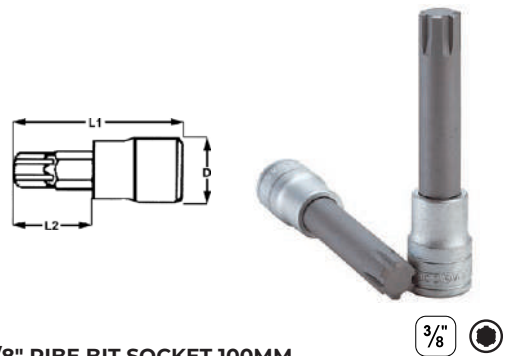

### 3/8" RIBE BIT SOCKET 100MM

- Chrome vanadium
- S2 steel bits pressed into the socket
- Satin finish for a better grip when handling the socket
- Ball recess on the female end to grip the ratchet
- Designed for use with fastenings with a multi spline RIBE type hole
- Supplied with a metal socket clip for use with a socket rail

ITEM ID:	Size	L1 mm	L2 mm	D mm	Weight g
M382704-C	04	100	74	17.9	40
M382705-C	05	100	74	17.9	43
M382706-C	06	100	74	17.9	47
M382708-C	08	100	74	17.9	60
M382709-C	09	100	74	17.9	68
M382710-C	10	100	74	17.9	75

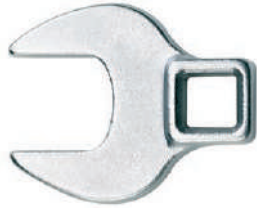
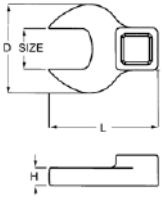

3/8" mm

**3/8" CROW FOOT WRENCH**

- Open ended spanner at right angle to square drive
- Ideal for accessing confined spaces
- Use with a ratchet or torque wrench with an extension bar
- Satin finish chrome vanadium
- Supplied with a metal socket clip for use with a socket rail

ITEM ID:	Size mm	L mm	H mm	D mm	Weight g
M386510-C	10	32.3	4.8	21.3	36
M386511-C	11	34.3	5.2	23.1	50
M386512-C	12	36.2	5.6	25.5	58
M386513-C	13	37.4	6	26.9	70
M386514-C	14	40	6.2	30.2	86
M386515-C	15	41.3	6.7	33.3	90
M386516-C	16	41.3	6.7	33.3	114
M386517-C	17	45.5	8.5	38.1	116
M386518-C	18	45.5	8.5	38.1	140
M386519-C	19	47.6	8.5	39.6	168



8 Pieces 3/8" mm

**3/8" CROW FOOT WRENCH CLIP RAIL SET**

- Open ended spanner at right angle to square drive
- Ideal for accessing confined spaces
- Use with a ratchet or torque wrench with an extension bar
- Satin finish chrome vanadium
- Supplied with a clip rail with socket clips for easy storage

3/8" Drive Crow Foot Wrenches

10, 11, 12, 13, 16, 17, 18, 19 mm

Item ID: **M3808MM**

**1/2" DRIVE SOCKETS**

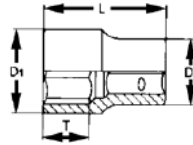

1/2" mm

**1/2" SOCKET 6 PT METRIC**

- 6 point single hexagon socket for a better grip
- Chrome vanadium
- Satin finish for a better grip when handling the socket
- Ball bearing recess on the female end to grip the ratchet
- Designed and manufactured to DIN3120/3124 and ISO2725
- Supplied with a metal socket clip for use with a socket rail

ITEM ID:	Size mm	L mm	Tmin mm	D1 mm	D2 mm	Weight g
M1205086-C	8	38	10	12.4	21.8	45
M1205106-C	10	38	10	15.5	21.8	45
M1205116-C	11	38	10	16.7	21.8	47
M1205126-C	12	38	10	18	21.8	49
M1205136-C	13	38	10	19.2	21.8	50
M1205146-C	14	38	10	20.5	21.8	50
M1205156-C	15	38	14	21	21.8	51
M1205166-C	16	38	14.3	22.5	23.3	55
M1205176-C	17	38	14.3	24.2	23	57
M1205186-C	18	38	15.3	24.7	23	61
M1205196-C	19	38	16.7	26.3	24	63
M1205206-C	20	38	17.3	27	24	66
M1205216-C	21	38	18	28	24	71
M1205226-C	22	40	18	29.8	26	97
M1205236-C	23	40	18	30.8	27	96
M1205246-C	24	40	18	31.8	26	93
M1205256-C	25	40	20	33.4	28	136
M1205266-C	26	40	20	34.8	29	140
M1205276-C	27	43	20	35.8	30	148
M1205286-C	28	43	20	37.8	31	172
M1205296-C	29	43	20	38.8	32	180
M1205306-C	30	43	20	39.8	33	180
M1205326-C	32	43	22	41.8	35	201
M1205336-C	33	45.5	23.5	42.8	35	235
M1205346-C	34	45.5	23.5	43.8	36	223

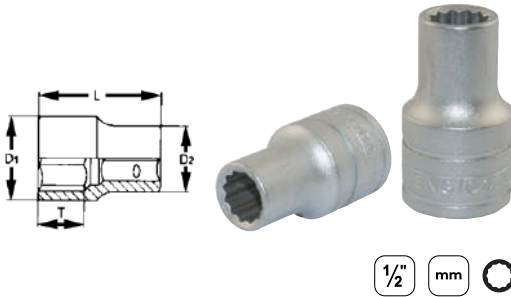

**1/2" SOCKET 12 PT METRIC**

- 12 point bi-hexagon socket for easier alignment
- Chrome vanadium
- Satin finish for a better grip when handling the socket
- Ball bearing recess on the female end to grip the ratchet
- Designed and manufactured to DIN3120/3124 and ISO2725
- Supplied with a metal socket clip for use with a socket rail

ITEM ID:	Size mm	L mm	Tmin mm	D1 mm	D2 mm	Weight g
M120508-C	8	38	9	13	21.8	43
M120509-C	9	38	10	14.5	21.8	45
M120510-C	10	38	10	15.5	21.8	45
M120511-C	11	38	10	16.7	21.8	47
M120512-C	12	38	10	18	21.8	49
M120513-C	13	38	10	19.2	21.8	50
M120514-C	14	38	10	20.5	21.8	50
M120515-C	15	38	14	21	21.8	51
M120516-C	16	38	14.3	22.5	23.3	55
M120517-C	17	38	15.3	24.2	23	57
M120518-C	18	38	16.7	24.7	23	61
M120519-C	19	38	17.3	26.3	24	63
M120520-C	20	38	18	27	23.7	66
M120521-C	21	38	18	28	24	68
M120522-C	22	40	18	29.8	26	92
M120523-C	23	40	18	30.8	27	92
M120524-C	24	40	20	31.8	26	95
M120525-C	25	40	20	33.4	28	136
M120526-C	26	40	20	34.8	29	140
M120527-C	27	43	20	35.8	30	148
M120528-C	28	43	20	37.8	31	172
M120529-C	29	43	20	38.8	32	180
M120530-C	30	43	22	39.8	33	172
M120532-C	32	43	23	41.8	35	189
M120534-C	34	45.5	23	43.8	36	223

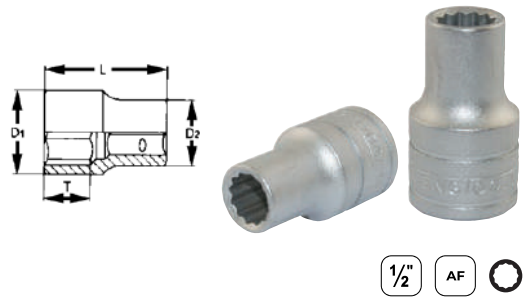

**1/2" SOCKET 12 PT AF**

- 12 point bi-hexagon socket for easier alignment
- Chrome vanadium
- Satin finish for a better grip when handling the socket
- Ball bearing recess on the female end to grip the ratchet
- Designed and manufactured to DIN3120/3124 and ISO2725
- Supplied with a metal socket clip for use with a socket rail

ITEM ID:	Size AF	L mm	Tmin mm	D1 mm	D2 mm	Weight g
M120112-C	3/8"	38	9	14.7	21.8	46
M120114-C	7/16"	38	9	17	21.8	50
M120116-C	1/2"	38	10	19	21.8	52
M120118-C	9/16"	38	12.5	20.8	21.8	55
M120119-C	19/32"	38	16	21	21.8	51
M120120-C	5/8"	38	14.3	22.5	23.3	62
M120122-C	11/16"	38	14.3	24.2	23.5	72
M120124-C	3/4"	38	20	26.3	24	76
M120125-C	25/32"	38	16	26.8	24	66
M120126-C	13/16"	38	20	27.7	24	80
M120128-C	7/8"	40	21	29.8	26	95
M120130-C	15/16"	40	21	31.8	26	110
M120132-C	1"	43	21	33.8	27.5	120
M120134-C	1-1/16"	43	23	35.8	29	145
M120136-C	1-1/8"	43	23	37.8	30.5	150
M120138-C	1-3/16"	43	23	39.8	32.5	190
M120140-C	1-1/4"	43	23	40.8	34	205



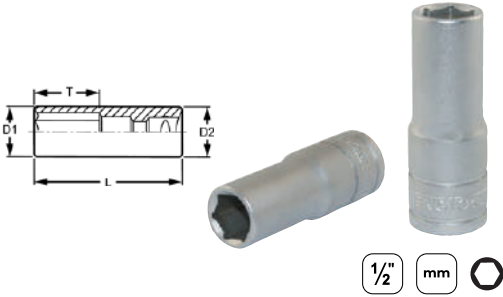

**1/2" DEEP SOCKET 6 PT METRIC**

- 6 point single hexagon socket for a better grip
- Chrome vanadium
- Satin finish for a better grip when handling the socket
- Ball bearing recess on the female end to grip the ratchet
- Designed and manufactured to DIN3120/3124 and ISO2725
- Supplied with a metal socket clip for use with a socket rail

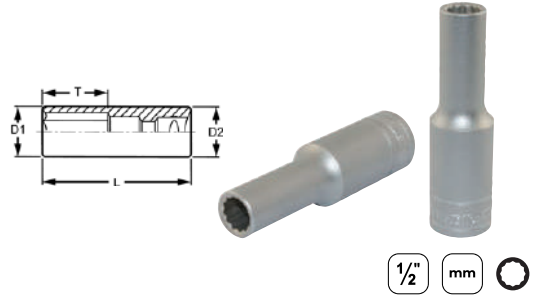

**1/2" DEEP SOCKET 12 PT METRIC**

- 12 point bi-hexagon socket for easier alignment
- Chrome vanadium
- Satin finish for a better grip when handling the socket
- Ball bearing recess on the female end to grip the ratchet
- Designed and manufactured to DIN3120/3124 and ISO2725
- Supplied with a metal socket clip for use with a socket rail

ITEM ID:	Size mm	L mm	Tmin mm	D1 mm	D2 mm	Weight g
M1206136-C	13	79	21	19.2	22	135
M1206146-C	14	79	25	20.5	22	135
M1206156-C	15	79	28	21.5	22	135
M1206166-C	16	79	31	22.5	23.3	150
M1206176-C	17	79	34	24.2	24.2	155
M1206186-C	18	79	34	25.4	25.4	165
M1206196-C	19	79	34	26.7	26.7	190
M1206246-C	24	79	34	31.8	31.8	240

ITEM ID:	Size mm	L mm	Tmin mm	D1 mm	D2 mm	Weight g
M120610-C	10	79	17	15.5	22	125
M120611-C	11	79	18	16.7	22	130
M120612-C	12	79	19	18	22	130
M120613-C	13	79	21	19.2	22	135
M120614-C	14	79	25	20.5	22	135
M120615-C	15	79	28	21.5	22	135
M120616-C	16	79	31	22.5	23.3	150
M120617-C	17	79	24	24.2	24.2	155
M120618-C	18	79	34	25.4	25.4	165
M120619-C	19	79	34	26.7	26.7	190
M120620-C	20	79	34	27.8	27.8	195
M120621-C	21	79	34	27.8	27.8	184
M120622-C	22	79	34	29.8	29.8	230
M120624-C	24	79	34	31.8	31.8	240
M120627-C	27	79	34	35.8	35.8	280
M120630-C	30	79	34	39.8	39.8	360
M120632-C	32	79	34	41.3	41.3	380
M120636-C	36	79	34	46	46	390

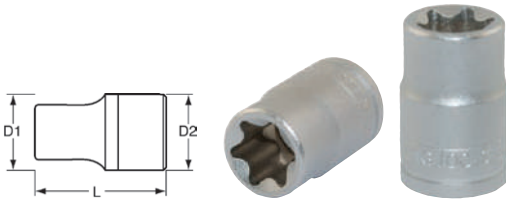

**1/2" TX-E SOCKET**

- Chrome vanadium
- Satin finish for a better grip when handling the socket
- Ball bearing recess on the female end to grip the ratchet
- Designed for use with protruding TX head screws
- Supplied with a metal socket clip for use with a socket rail

ITEM ID:	Size	Size mm	L mm	Tmin mm	D1 mm	D2 mm	Weight g
M120710-C	E10	9.42	37.8	9.5	13.1	23.5	39
M120711-C	E11	10.08	37.8	9.5	14.1	23.5	42
M120712-C	E12	11.17	37.8	9.5	14.9	23.5	43
M120714-C	E14	12.9	37.8	12.3	16.7	23.5	44
M120716-C	E16	14.76	37.8	13	19.1	23.5	49
M120718-C	E18	16.7	37.8	13	20.9	23.5	52
M120720-C	E20	18.45	37.8	13	23.7	23.5	60
M120722-C	E22	20.3	37.8	16.1	26.1	26.1	82
M120724-C	E24	22.16	37.8	16.4	28	28	102

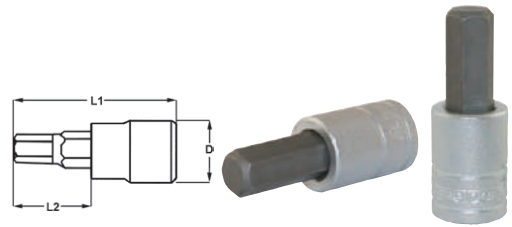

**1/2" HEX BIT SOCKET METRIC**

- Chrome vanadium
- S2 steel bits pressed in to the socket
- Satin finish for a better grip when handling the socket
- Ball bearing recess on the female end to grip the ratchet
- Designed for use with fastenings with a hexagon hole
- Use with in-hex screws or grub screws
- Designed and manufactured to DIN7422
- Supplied with a metal socket clip for use with a socket rail

ITEM ID:	Size mm	L1 mm	L2 mm	D mm	Weight g
M121505-C	5	55	20.5	22	52
M121506-C	6	55	20.5	22	54
M121507-C	7	55	20.5	22	60
M121508-C	8	55	20.5	22	62
M121509-C	9	55	20.5	22	66
M121510-C	10	55	20.5	22	72
M121512-C	12	55	20.5	22	80
M121514-C	14	55	20.5	22	96
M121515-C	15	55	35	22	105
M121516-C	16	55	35	25	130
M121517-C	17	55	20.5	25	154
M121518-C	18	55	38	28	140
M121519-C	19	60	23	25.9	182



**TT SERIES**

Socket Sets available

**MODULAR TOOL CONTROL SYSTEM**



**PAGE 55**

**FOAM SERIES**

Socket Sets available

**MODULAR TOOL CONTROL SYSTEM**



**PAGE 122**



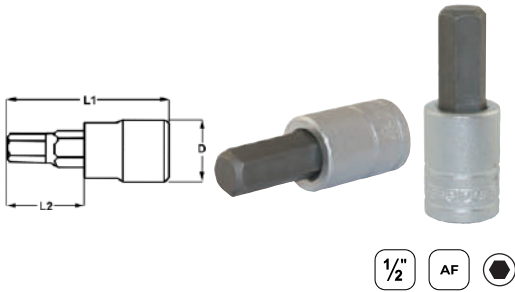

**1/2" HEX BIT SOCKET AF**

- Chrome vanadium
- S2 steel bits pressed in to the socket
- Satin finish for a better grip when handling the socket
- Ball bearing recess on the female end to grip the ratchet
- Designed for use with fastenings with a hexagon hole
- Use with in-hex screws or grub screws
- Designed and manufactured to DIN7422
- Supplied with a metal socket clip for use with a socket rail

ITEM ID:	Size AF	L1 mm	L2 mm	D mm	Weight g
M121106-C	3/16"	55	20	22	55
M121107-C	7/32"	55	20	22	55
M121108-C	1/4"	55	20	22	55
M121109-C	9/32"	55	20	22	60
M121110-C	5/16"	55	20	22	62
M121112-C	3/8"	55	20	22	67
M121116-C	1/2"	55	20	22	85
M121118-C	9/16"	55	20	22	100
M121120-C	5/8"	55	20	22	120

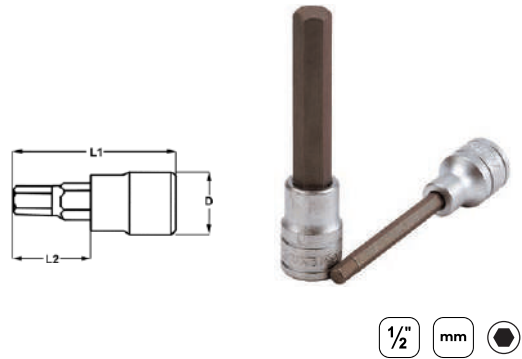

**1/2" LONG HEX BIT SOCKET METRIC**

- Chrome vanadium
- S2 steel bits pressed in to the socket
- Satin finish for a better grip when handling the socket
- Ball bearing recess on the female end to grip the ratchet
- Designed for use with fastenings with a hexagon hole
- Use with in-hex screws or grub screws
- Designed and manufactured to DIN7422
- Supplied with a metal socket clip for use with a socket rail

ITEM ID:	Size mm	L1 mm	L2 mm	D mm	Weight g
M122505-C	5	100	65.5	22	60
M122506-C	6	100	65.5	22	60
M122506A-C	6	115	80	22	100
M122507-C	7	100	65.5	22	80
M122508-C	8	100	65.5	22	80
M122508A-C	8	115	80	22	120
M122510-C	10	100	65.5	22	100
M122510L-C	10	175	140	22	150
M122512-C	12	100	65.5	22	120
M122514-C	14	100	65.5	22	153
M122517-C	17	100	65.5	25	225

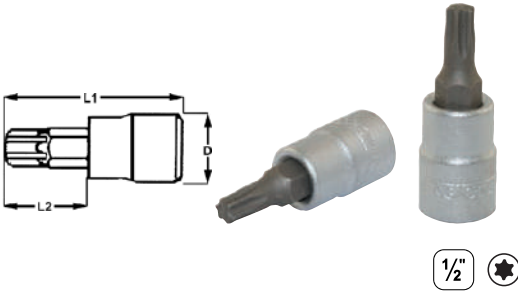

**1/2" TX BIT SOCKET**

- Chrome vanadium
- S2 steel bits pressed in to the socket
- Satin finish for a better grip when handling the socket
- Ball bearing recess on the female end to grip the ratchet
- Designed for use with fastenings with a TX hole
- Supplied with a metal socket clip for use with a socket rail

ITEM ID:	Size	L1 mm	L2 mm	D mm	Weight g
M121220T-C	TX20	55	20.5	22	64
M121225T-C	TX25	55	20.5	22	64
M121227T-C	TX27	55	20.5	22	64
M121230T-C	TX30	55	20.5	22	64
M121240T-C	TX40	55	20.5	22	64
M121245T-C	TX45	55	20.5	22	74
M121250T-C	TX50	55	20.5	22	74
M121255T-C	TX55	55	20.5	22	80
M121260T-C	TX60	55	20.5	22	80

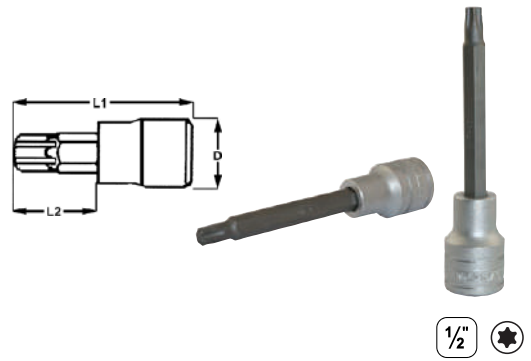

**1/2" LONG TX BIT SOCKET**

- Chrome vanadium
- S2 steel bits pressed in to the socket
- Satin finish for a better grip when handling the socket
- Ball bearing recess on the female end to grip the ratchet
- Designed for use with fastenings with a TX hole
- Supplied with a metal socket clip for use with a socket rail

ITEM ID:	Size	L1 mm	L2 mm	D mm	Weight g
M122220T-C	TX20	100	65.5	22	82
M122225T-C	TX25	100	65.5	22	82
M122227T-C	TX27	100	65.5	22	82
M122230T-C	TX30	100	65.5	22	82
M122240T-C	TX40	100	65.5	22	85
M122245T-C	TX45	100	65.5	22	85
M122250T-C	TX50	100	65.5	22	100
M122255T-C	TX55	100	65.5	22	105
M122260T-C	TX60	100	65.5	22	135
M122270T-C	TX70	100	65.5	22	135



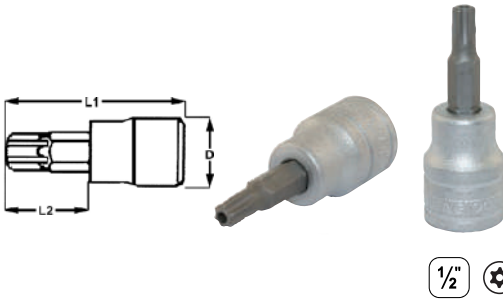

**1/2" TPX BIT SOCKET**

- Chrome vanadium
- S2 steel bits pressed in to the socket
- Satin finish for a better grip when handling the socket
- Ball bearing recess on the female end to grip the ratchet
- Designed for use with fastenings with a TX hole with a security pin
- Supplied with a metal socket clip for use with a socket rail

ITEM ID:	Size	L1 mm	L2 mm	D mm	Weight g
M121220-C	TPX20	55	20.5	22	64
M121225-C	TPX25	55	20.5	22	64
M121227-C	TPX27	55	20.5	22	64
M121230-C	TPX30	55	20.5	22	64
M121240-C	TPX40	55	20.5	22	64
M121245-C	TPX45	55	20.5	22	74
M121250-C	TPX50	55	20.5	22	74
M121255-C	TPX55	55	20.5	22	80
M121260-C	TPX60	55	20.5	22	80

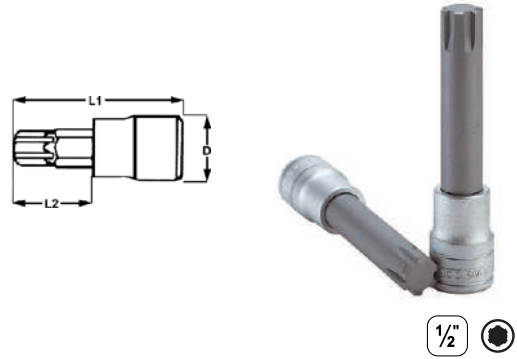

**1/2" LONG RIBE BIT SOCKET**

- Chrome vanadium
- S2 steel bits pressed in to the socket
- Satin finish for a better grip when handling the socket
- Ball bearing recess on the female end to grip the ratchet
- Designed for use with fastenings with a multi spline RIBE type hole
- Supplied with a metal socket clip for use with a socket rail

ITEM ID:	Size	L1 mm	L2 mm	D mm	Weight g
M122704-C	04	100	65	22	70
M122705-C	05	100	65	22	70
M122706-C	06	100	65	22	70
M122708-C	08	100	65	22	70
M122709-C	09	100	65	22	70
M122710-C	10	100	65	22	90
M122711-C	11	100	65	22	100
M122712-C	12	100	65	22	110
M122713-C	13	100	65	22	120

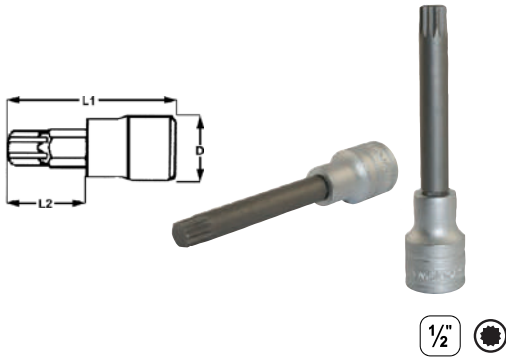

**1/2" LONG XZN BIT SOCKET**

- Chrome vanadium
- S2 steel bits pressed in to the socket
- Satin finish for a better grip when handling the socket
- Ball bearing recess on the female end to grip the ratchet
- Designed for use with fastenings with a multi point XZN type hole
- Supplied with a metal socket clip for use with a socket rail

ITEM ID:	Size	L1 mm	L2 mm	D mm	Weight g
M122805-C	05	100	65	22	70
M122806-C	06	100	65	22	70
M122808-C	08	100	65	22	70
M122809-C	09	100	65	22	70
M122810-C	10	100	65	22	90
M122812-C	12	100	65	22	110
M122814-C	14	100	65	22	130
M122816-C	16	100	65	22	160

**3/4" DRIVE SOCKETS**

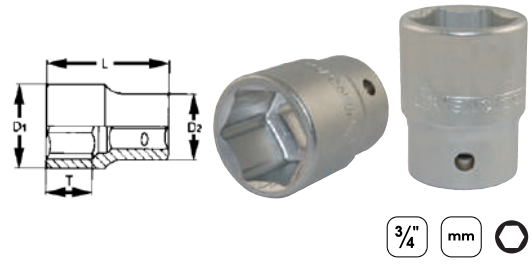

**3/4" SOCKET 6 PT METRIC**

- 6 point single hexagon socket for a better grip
- Chrome vanadium
- Satin finish for a better grip when handling the socket
- Ball bearing recess on the female end to grip the ratchet
- Designed and manufactured to DIN3120/3124 and ISO2725
- Supplied with a metal socket clip for use with a socket rail

ITEM ID:	Size mm	L mm	Tmin mm	D1 mm	D2 mm	Weight g
M3405196-C	19	50	14	29.2	33	180
M3405216-C	21	50	14	31.2	33	180
M3405226-C	22	50	14	32.2	36	220
M3405246-C	24	51	16	34.2	36	230
M3405266-C	26	52	18	36	36	240
M3405276-C	27	52	22	38	36	240
M3405306-C	30	54	24	42	38	260
M3405326-C	32	56	26	44	38	310
M3405336-C	33	56	26	46	38	330
M3405346-C	34	56	26	47	38	350
M3405366-C	36	58	28	50	38	430
M3405386-C	38	60	28	52	42	500
M3405416-C	41	64	30	56	45	570
M3405466-C	46	68	34	62	45	690
M3405506-C	50	72	36	68	48	830



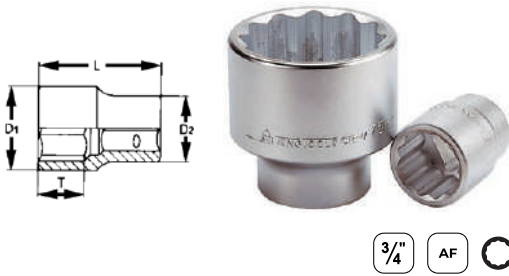

**3/4" SOCKET 12 PT AF**

- 12 point bi-hexagon socket for easier alignment
- Chrome vanadium
- Satin finish for a better grip when handling the socket
- Ball bearing recess on the female end to grip the ratchet
- Designed and manufactured to DIN3120/3124 and ISO2725
- Supplied with a metal socket clip for use with a socket rail

ITEM ID:	Size AF	L mm	Tmin mm	D1 mm	D2 mm	Weight g
M340124-C	3/4"	50	14	29.2	33	180
M340128-C	7/8"	51	18.1	32.2	36.2	195
M340130-C	15/16"	51	18.1	34.5	36.2	200
M340132-C	1"	51	24	37	37	200
M340134-C	1-1/16"	51	24	38.3	37	200
M340136-C	1-1/8"	51	24.3	40	38.5	230
M340138-C	1-3/16"	53	25.2	42	38.5	255
M340140-C	1-1/4"	55	28	44	38.5	275
M340142-C	1-5/16"	55	28	46	38.5	300
M340144-C	1-3/8"	57	29.7	48	42.3	360
M340146-C	1-7/16"	57	29.7	50	42.3	380
M340148-C	1-1/2"	60	31.1	52.1	45.2	440
M340152-C	1-5/8"	63	33.7	56.1	45.2	515
M340156-C	1-3/4"	65	33.7	60	48	610
M340158-C	1-13/16"	67	35.7	62	48	635
M340160-C	1-7/8"	69	37.2	64	48.3	690
M340164-C	2"	71	38.6	68.2	48.3	755

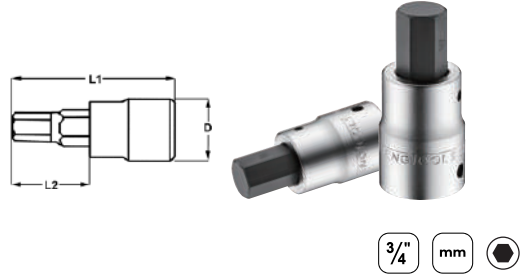

**3/4" HEX BIT SOCKET METRIC**

- Chrome vanadium
- S2 steel bits pressed in to the socket
- Satin finish for a better grip when handling the socket
- Ball bearing recess on the female end to grip the ratchet
- Designed for use with fastenings with a hexagon hole
- Use with in-hex screws or grub screws
- Supplied with a metal socket clip for use with a socket rail

ITEM ID:	Size mm	L1 mm	L2 mm	D mm	Weight g
M341514-C	14	78.5	25	36	326
M341517-C	17	78.5	25	36	330
M341519-C	19	78.5	25	36	334
M341522-C	22	78.5	25	36	338

1" DRIVE SOCKETS

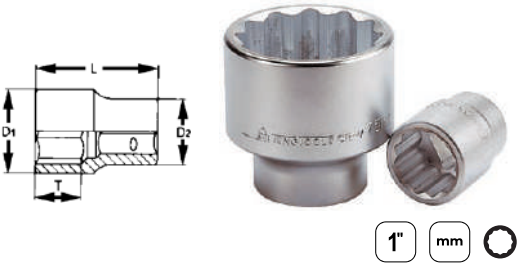

1" SOCKET 12 PT METRIC

- 12 point bi-hexagon socket for easier alignment
- Chrome vanadium
- Satin finish for a better grip when handling the socket
- Ball bearing recess on the female end to grip the ratchet
- Designed and manufactured to DIN3120/3124 and ISO2725

ITEM ID:	Size mm	L mm	Tmin mm	D1 mm	D2 mm	Weight g
M110536	36	65.3	31.2	51	45.2	440
M110541	41	70.2	33.8	57.1	45.2	550
M110546	46	74.5	37.5	64.6	49.4	810
M110550	50	75.3	38.1	69.9	55.2	995
M110555	55	80	40	76.2	57.3	1160
M110558	58	80	40	79.2	57.3	1250
M110560	60	84	41	82.1	57.3	1410
M110565	65	87.3	46.2	88	57.3	1540
M110570	70	93.4	51.5	94	68.1	2020
M110575	75	96.1	51.5	94	68.1	2020
M110580	80	103.6	55.3	105	68.1	2500

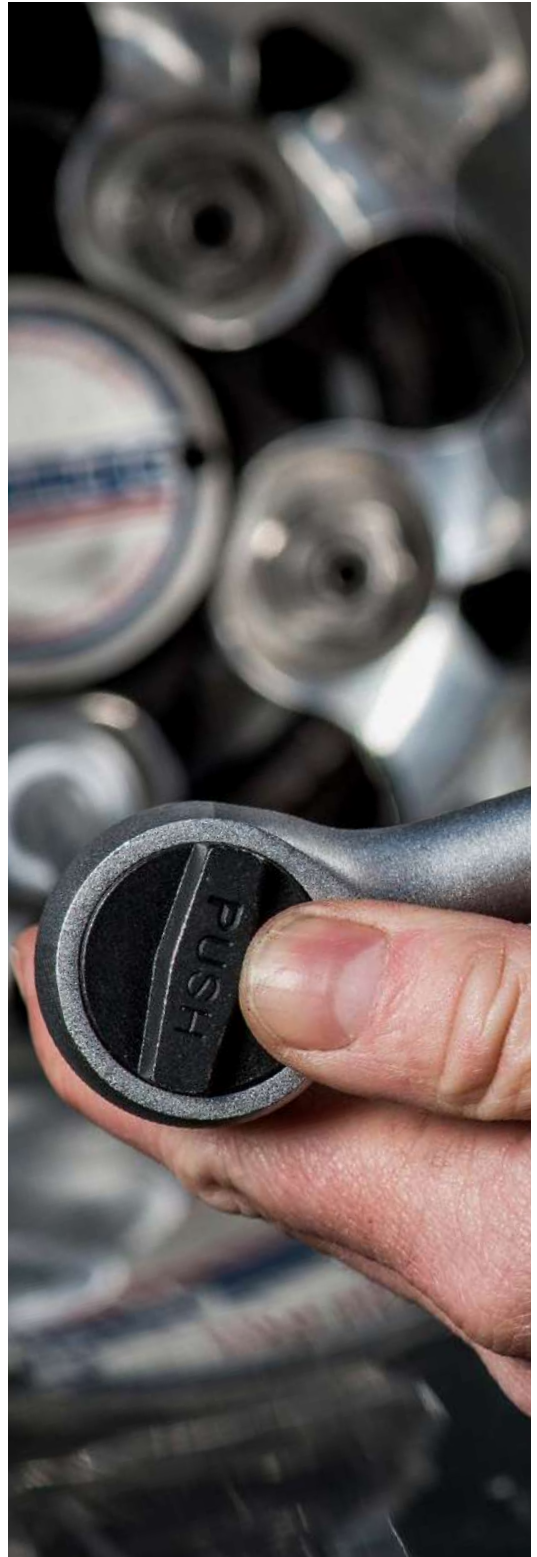

# IMPACT SOCKETS

## Quality construction, maximum efficiency

Impact tools use air or electricity rather than using human strength to turn a socket. When in use they are slammed into the anvil at a high rate of speed, providing a significant mechanical advantage when trying to turn a bolt. The repeated impact, combined with the torque applied to the socket, requires a different approach in the construction of the tool.



## IMPACT ACCESSORIES



ITEM ID:	Drive	Description	Standard	Retaining	
				Ring	Pin
980020-C	3/8"	3" extension bar	DIN	O92416	P902515
980035-C	3/8"	3/8"F:1/4"M adaptor	DIN	O92416	P902515
980036-C	3/8"	3/8"F:1/2"M adaptor	DIN	O92416	P902515
980036A-C	3/8"	3/8"F:1/2"M adaptor	ANSI	-	-
980060-C	3/8"	Coupler adaptor: 1/4" hex	ANSI	-	-
980086	3/8"	3/8"M:5/16"hex	ANSI	-	-

ITEM ID:	Drive	Description	Standard	Retaining	
				Ring	Pin
920020N	1/2"	3" extension bar	DIN	O92194	P92320
920020AN	1/2"	3" extension bar	ANSI	-	-
920021N	1/2"	5" extension bar	DIN	O92194	P92320
920021AN	1/2"	5" extension bar	ANSI	-	-
920023N	1/2"	10" extension bar	DIN	O92194	P92320
920023AN	1/2"	10" extension bar	ANSI	-	-
920030N	1/2"	universal joint	DIN	O92194	P92320
920030AN	1/2"	universal joint	ANSI	-	-
920036N	1/2"	1/2"F:3/8"M adaptor	DIN	O92194	P92320
920036AN	1/2"	1/2"F:3/8"M adaptor	ANSI	-	-
920037N	1/2"	1/2"F:3/4"M adaptor	DIN	O92194	P92320
920037AN	1/2"	1/2"F:3/4"M adaptor	ANSI	-	-
920060-C	1/2"	coupler adaptor: 5/16" hex	ANSI	-	-

3/8"

1/2"

3/4"

1"

ITEM ID:	Drive	Description	Standard	Retaining	
				Ring	Pin
940022-C	3/4"	7" extension bar	DIN	O95036	P90435
940030-C	3/4"	universal joint	DIN	O93538	P90437
940037-C	3/4"	3/4"F:1/2"M adaptor	DIN	O95036	P90435
940085-C	3/4"	3/4"F:1"M adaptor	DIN	O95036	P90435

ITEM ID:	Drive	Description	Standard	Retaining	
				Ring	Pin
910086	1"	1"F:3/4"M adaptor	DIN	O97045	P90545

## RETAINING RINGS &amp; PINS

ITEM ID:	Description
O92416	Retaining Ring 16 x 2.4mm
O92419	Retaining Ring 19 x 2.4mm
O93530	Retaining Ring 30 x 3.5mm
O93546	Retaining Ring 46 x 3.5mm
O93548	Retaining Ring 48 x 3.5mm
O92194	Retaining ring 19x4.0mm
O92244	Retaining ring 24x4.0mm
O95034	Retaining ring 34x5mm
O95036	Retaining ring 36x5mm
O95775	Retaining ring Retaining Ring 75 x 5.7mm
O97043	Retaining ring 43x7mm
O97045	Retaining ring 45x7mm
O95046	Retaining ring 46x5mm
O97051	Retaining ring 51x7mm
O910075	Retaining ring 75x10mm
O9100115	Retaining ring 115x10mm
P92320	Retaining pin 3x20mm
P92325	Retaining pin 3x25mm
P90433	Retaining pin 4x33mm
P90435	Retaining pin 4x35mm
P90445	Retaining pin 4x45mm
P90543	Retaining pin 5x43mm
P90545	Retaining pin 5x45mm
P90551	Retaining pin 5x51mm
P90675	Retaining pin 6x75mm
P906110	Retaining pin 6x110mm



**1/4" DRIVE IMPACT SOCKETS**

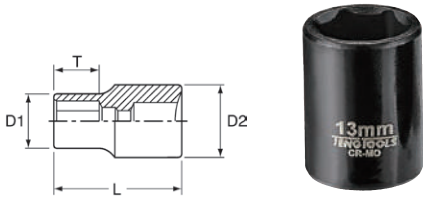

**1/4" IMPACT SOCKET ANSI METRIC**

- ANSI standard design with a ball bearing socket retainer
- Chrome molybdenum for use with power tools
- Black phosphate finish for easy identification as an impact socket accessory

ITEM ID:	Size mm	L mm	T mm	D1 mm	D2 mm	Weight g
960506-C	6	21.2	10	9.5	12	20
960507-C	7	21.2	11	11	12	20
960508-C	8	21.2	11	12	12	20
960510-C	10	21.2	12.5	14	12	20
960513-C	13	21.2	12	18	12	20

**3/8" DRIVE IMPACT SOCKETS**

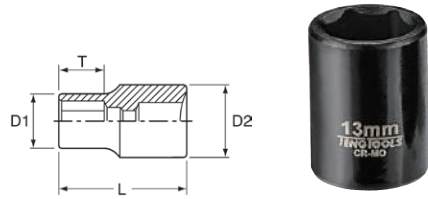

**3/8" IMPACT SOCKET ANSI METRIC**

- ANSI standard design with a ball bearing socket retainer
- Chrome molybdenum for use with power tools
- Black phosphate finish for easy identification as an impact socket accessory

ITEM ID:	Size mm	L mm	T mm	D1 mm	D2 mm	Weight g
980508-C	8	30	8	12.5	19	33
980510-C	10	30	8	15	19	34
980511-C	11	30	9	17	19	37
980512-C	12	30	9	19	19	40
980513-C	13	30	9	19	19	41
980514-C	14	30	9	20	20	41
980515-C	15	30	11	22	22	64
980516-C	16	30	11	24	24	64
980517-C	17	30	11	24	24	64
980519-C	19	30	11	26	26	72



**TT SERIES** Impact Sets available

**MODULAR TOOL CONTROL SYSTEM**

**PAGE 63**

**FOAM SERIES** Impact Sets available

**MODULAR TOOL CONTROL SYSTEM**

**PAGE 129**

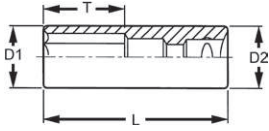

**3/8" DEEP IMPACT SOCKET ANSI METRIC**

- ANSI standard design with a ball bearing socket retainer
- Chrome molybdenum for use with power tools
- Black phosphate finish for easy identification as an impact socket accessory

ITEM ID:	Size mm	L mm	T mm	D1 mm	D2 mm	Weight g
980608-C	8	65	12.8	12.6	19	95
980610-C	10	65	26	15.2	19	89
980611-C	11	65	27	17	19	87
980612-C	12	65	27	19	19	85
980613-C	13	65	27	19	19	80
980614-C	14	65	27	20	20	87
980616-C	16	65	27	24	24	144
980617-C	17	65	27	24	24	130
980619-C	19	65	27	26	26	143

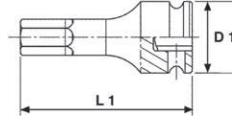

**3/8" HEX BIT IMPACT SOCKET DIN METRIC**

- DIN standard design for use with a retaining pin and ring
- Chrome molybdenum for use with power tools
- Black phosphate finish for easy identification as an impact socket accessory
- Ring and pin fixing hole on the female end to secure the socket
- Designed for use with fastenings with a hexagon hole
- Use with in-hex screws or grub screws
- Supplied with a metal socket clip for use with a socket rail

ITEM ID:	Size mm	L mm	D1 mm	Weight g	Retaining Ring	Retaining Pin
981504-C	4	52	20.8	55	O935202	P90320
981505-C	5	52	20.8	57	O935202	P90320
981506-C	6	52	20.8	60	O935202	P90320
981507-C	7	52	20.8	63	O935202	P90320
981508-C	8	52	20.8	67	O935202	P90320
981510-C	10	52	20.8	74	O935202	P90320
981512-C	12	52	20.8	85	O935202	P90320



DIN Standard sockets require a retaining ring and pin to safely secure the socket to the impact tool.



1/2" DRIVE IMPACT SOCKETS

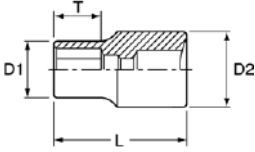

1/2" IMPACT SOCKET DIN METRIC

- DIN standard design for use with a retaining pin and ring
- Chrome molybdenum for use with power tools
- Black phosphate finish for easy identification as an impact socket accessory
- Ring and pin fixing hole on the female end to secure the socket
- Designed and manufactured to DIN3129

ITEM ID:	Size mm	L mm	T(min) mm	D1 mm	D2 mm	Retaining Ring	Retaining Pin
920508N	8	38	5	15	25	O92194	P92320
920510N	10	38	6	17	25	O92194	P92320
920511N	11	38	7	18.5	25	O92194	P92320
920512N	12	38	8	20	25	O92194	P92320
920513N	13	38	8	21	25	O92194	P92320
920514N	14	38	10	22.5	25	O92194	P92320
920515N	15	38	10	23	30	O92244	P92325
920516N	16	38	10	25	30	O92244	P92325
920517N1	17	38	10	26	30	O92244	P92325
920518N	18	38	12	27.5	30	O92244	P92325
920519N1	19	38	12	28.5	30	O92244	P92325
920520N	20	38	12	30	30	O92244	P92325
920521N1	21	38	12	31	30	O92244	P92325
920522N	22	38	14	32.5	30	O92244	P92325
920523N	23	38	16	34	30	O92244	P92325
920524N	24	38	16	35	30	O92244	P92325
920525N	25	45	18	36	30	O92244	P92325
920526N	26	45	18	37.5	30	O92244	P92325
920527N	27	45	18	38.5	30	O92244	P92325
920528N	28	47	20	40	30	O92244	P92325
920529N	29	47	20	41	30	O92244	P92325
920530N	30	50	20	42	30	O92244	P92325
920532N	32	50	22	44	30	O92244	P92325

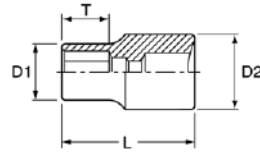

1/2" IMPACT SOCKET ANSI METRIC

- ANSI standard design with a ball bearing socket retainer
- Chrome molybdenum for use with power tools
- Black phosphate finish for easy identification as an impact socket accessory

ITEM ID:	Size mm	L mm	T(min) mm	D1 mm	D2 mm
920510AN	10	38	4.6	17	22
920511AN	11	38	5.5	17	22
920512AN	12	38	6.1	19	22
920513AN	13	38	6.8	20	24
920514AN	14	38	8.4	21	24
920515AN	15	38	8.4	23	25
920516AN	16	38	9.5	25	25
920517AN	17	38	9.5	26	26
920518AN	18	38	10.2	28	26
920519AN	19	38	11.1	28	28
920521AN	21	38	11.7	30	30
920522AN	22	38	12.5	32	32
920524AN	24	38	13.9	36	36

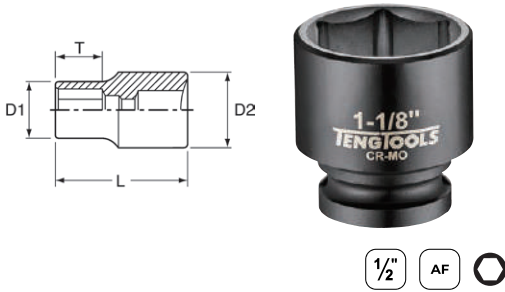

**1/2" IMPACT SOCKET DIN AF**

- DIN standard design for use with a retaining pin and ring
- Chrome molybdenum for use with power tools
- Black phosphate finish for easy identification as an impact socket accessory
- Ring and pin fixing hole on the female end to secure the socket
- Supplied with a metal socket clip for use with a socket rail

ITEM ID:	Size AF	L mm	T(min) mm	D1 mm	D2 mm	Retaining Ring	Retaining Pin
920112	3/8"	38	3.9	16.1	24	O92194	P92320
920114	7/16"	38	5.5	17.8	24	O92194	P92320
920116	1/2"	38	6.7	19.9	24	O92194	P92320
920118	9/16"	38	8.3	21.9	24	O92194	P92320
920120	5/8"	38	9.5	24	24	O92194	P92320
920122	11/16"	38	9.5	26	26	O92244	P92325
920124	3/4"	38	11.1	28	28	O92244	P92325
920126	13/16"	38	11.5	30	30	O92244	P92325
920128	7/8"	38	12.7	32	30	O92244	P92325
920130	15/16"	38	12.7	33.9	30	O92244	P92325
920132	1"	40	13.8	35.6	30	O92244	P92325
920134	1-1/16"	42	15.8	37.6	30	O92244	P92325
920136	1-1/8"	42	16.6	39.8	30	O92244	P92325
920140	1-1/4"	44	16.6	44	30	O92244	P92325

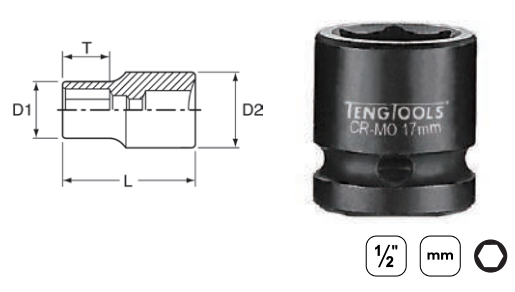

**1/2" STUBBY IMPACT SOCKET DIN METRIC**

- Short reach for use in confined spaces
- DIN standard design for use with a retaining pin and ring
- Chrome molybdenum for use with power tools
- Black phosphate finish for easy identification as an impact socket accessory
- Ring and pin fixing hole on the female end to secure the socket
- Designed and manufactured to DIN3129

ITEM ID:	Size mm	L mm	T(min) mm	D1 mm	D2 mm	Retaining Ring	Retaining Pin
920710-C	10	28	5	18	24	O92194	P92320
920712-C	12	28	5	20	24	O92194	P92320
920713-C	13	28	5	20	24	O92194	P92320
920714-C	14	28	5	22	24	O92194	P92320
920715-C	15	28	5	24	24	O92194	P92320
920716-C	16	28	5	24	24	O92194	P92320
920717-C	17	28	10	26	26	O92244	P92325
920718-C	18	28	10	28	28	O92244	P92325
920719-C	19	28	10	28	28	O92244	P92325
920721-C	21	28	10	30	30	O92244	P92325
920722-C	22	28	10	32	30	O92244	P92325
920724-C	24	28	10	34	30	O92244	P92325



**TT SERIES** Impact Sets available

**MODULAR TOOL CONTROL SYSTEM**

**PAGE 63**

**FOAM SERIES** Impact Sets available

**MODULAR TOOL CONTROL SYSTEM**

**PAGE 129**

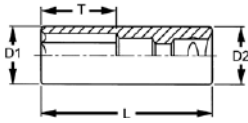

**1/2" DEEP IMPACT SOCKET DIN METRIC**

- DIN standard design for use with a retaining pin and ring
- Chrome molybdenum for use with power tools
- Black phosphate finish for easy identification as an impact socket accessory
- Ring and pin fixing hole on the female end to secure the socket
- Designed and manufactured to DIN3129

ITEM ID:	Size mm	L mm	T(min) mm	D1 mm	D2 mm	Retaining Ring	Retaining Pin
920610N	10	80	9	17	25	O92194	P92320
920611N	11	80	10.5	18.5	25	O92194	P92320
920612N	12	80	12	20	25	O92194	P92320
920613N	13	80	12	21	25	O92194	P92320
920614N	14	80	15	22.5	25	O92194	P92320
920615N	15	80	15	23	30	O92244	P92325
920616N	16	80	15	25	30	O92244	P92325
920617N	17	80	15	26	30	O92244	P92325
920618N	18	80	18	27.5	30	O92244	P92325
920619N	19	80	18	28.5	30	O92244	P92325
920620N	20	80	18	30	30	O92244	P92325
920621N	21	80	18	31	30	O92244	P92325
920622N	22	80	21	32.5	30	O92244	P92325
920623N	23	80	24	34	30	O92244	P92325
920624N	24	80	24	35	30	O92244	P92325
920627N	27	80	27	38.5	30	O92244	P92325
920628N	28	80	30	40	30	O92244	P92325
920629N	29	80	30	40	30	O92244	P92325
920630N	30	80	30	42	30	O92244	P92325
920632N	32	80	33	44	30	O92244	P92325
920635N	35	80	33	48	30	O92244	P92325
920636N	36	80	33	50	30	O92244	P92325

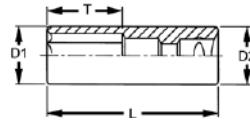

**1/2" DEEP IMPACT SOCKET ANSI METRIC**

- ANSI standard design with a ball bearing socket retainer
- Chrome molybdenum for use with power tools
- Black phosphate finish for easy identification as an impact socket accessory

ITEM ID:	Size mm	L mm	T(min) mm	D1 mm	D2 mm
920610AN	10	78	4.6	17	22
920611AN	11	78	5.5	18	22
920612AN	12	78	6.1	19	22
920613AN	13	78	6.8	22	24
920614AN	14	78	8.4	22	24
920615AN	15	78	8.4	24	24
920616AN	16	78	9.5	24	24
920617AN	17	78	9.5	26	26
920618AN	18	78	10.2	28	28
920619AN	19	78	11.1	28	28
920621AN	21	78	11.7	30	30
920622AN	22	78	12.5	32	32
920624AN	24	78	13.9	35.8	35.8

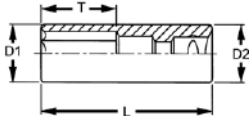

### 1/2" DEEP IMPACT SOCKET DIN AF

- DIN standard design for use with a retaining pin and ring
- Chrome molybdenum for use with power tools
- Black phosphate finish for easy identification as an impact socket accessory
- Ring and pin fixing hole on the female end to secure the socket
- Supplied with a metal socket clip for use with a socket rail

ITEM ID:	Size AF	L mm	T(min) mm	D1 mm	D2 mm	Retaining Ring	Retaining Pin
920212	3/8"	78	3.9	16	24	O92194	P92320
920214	7/16"	78	5.5	18	24	O92194	P92320
920216	1/2"	78	6.7	20.4	24	O92194	P92320
920218	9/16"	78	8.3	22	24	O92194	P92320
920220	5/8"	78	9.5	24	24	O92194	P92320
920222	11/16"	78	9.5	26	26	O92244	P92325
920224	3/4"	78	11.1	28	28	O92244	P92325
920226	13/16"	78	11.5	30	30	O92244	P92325
920228	7/8"	78	12.7	32	30	O92244	P92325
920230	15/16"	78	12.7	34	30	O92244	P92325
920232	1"	78	13.8	36	30	O92244	P92325
920234	1-1/16"	78	15.8	38	30	O92244	P92325
920236	1-1/8"	78	16.6	40	30	O92244	P92325
920240	1-1/4"	78	16.6	44.4	30	O92244	P92325
920242	1-5/16"	80	16.6	46	30	O92244	P92325
920248	1-1/2"	80	16.6	52	30	O92244	P92325

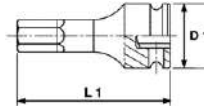

### 1/2" HEX IMPACT SOCKET DIN METRIC

- DIN standard design for use with a retaining pin and ring
- Chrome molybdenum for use with power tools
- Black phosphate finish for easy identification as an impact socket accessory
- Ring and pin fixing hole on the female end to secure the socket
- Designed for use with fastenings with a hexagon hole
- Use with in-hex screws or grub screws
- Supplied with a metal socket clip for use with a socket rail

ITEM ID:	Size mm	L mm	D1 mm	Weight g	Retaining Ring	Retaining Pin
921505-C	5	78	25	81	O92194	P92320
921506-C	6	78	25	86	O92194	P92320
921508-C	8	78	25	100	O92194	P92320
921510-C	10	78	25	114	O92194	P92320
921512-C	12	78	25	132	O92194	P92320
921514-C	14	78	25	155	O92194	P92320
921517-C	17	78	25	191	O92194	P92320
921519-C	19	78	25	216	O92194	P92320



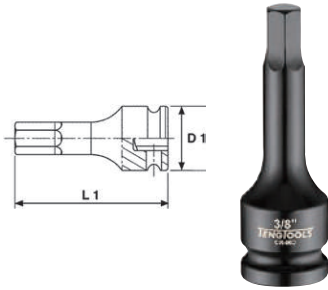

**1/2" HEX IMPACT SOCKET DIN AF**

- DIN standard design for use with a retaining pin and ring
- Chrome molybdenum for use with power tools
- Black phosphate finish for easy identification as an impact socket accessory
- Ring and pin fixing hole on the female end to secure the socket
- Designed for use with fastenings with a hexagon hole
- Use with in-hex screws or grub screws
- Supplied with a metal socket clip for use with a socket rail

ITEM ID:	Size mm	L mm	D1 mm	Weight g	Retaining Ring	Retaining Pin
921606	3/16"	78	24.8	80	O92194	P92320
921608	1/4"	78	24.8	90	O92194	P92320
921610	5/16"	78	24.8	100	O92194	P92320
921612	3/8"	78	24.8	110	O92194	P92320
921614	7/16"	78	24.8	130	O92194	P92320
921616	1/2"	78	24.8	150	O92194	P92320
921618	9/16"	78	24.8	180	O92194	P92320
921620	5/8"	78	24.8	190	O92194	P92320
921622	11/16"	78	24.8	200	O92194	P92320
921624	3/4"	78	24.8	220	O92194	P92320

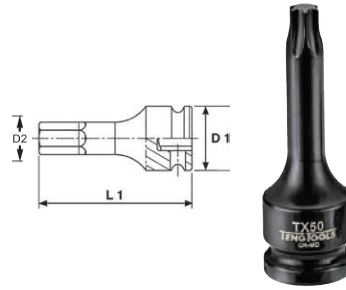

**1/2" TX IMPACT SOCKET DIN**

- DIN standard design for use with a retaining pin and ring
- Chrome molybdenum for use with power tools
- Black phosphate finish for easy identification as an impact socket accessory
- Ring and pin fixing hole on the female end to secure the socket
- Designed for use with fastenings with a TX hole
- Supplied with a metal socket clip for use with a socket rail

ITEM ID:	Size	L mm	D1 mm	D2 mm	Weight g	Retaining Ring	Retaining Pin
921210TX-C	TX10	78	25	6.5	73	O92194	P92320
921215TX-C	TX15	78	25	6.5	74	O92194	P92320
921220TX-C	TX20	78	25	6.5	74	O92194	P92320
921225TX-C	TX25	78	25	6.5	74	O92194	P92320
921227TX-C	TX27	78	25	6.5	78	O92194	P92320
921230TX-C	TX30	78	25	6.5	79	O92194	P92320
921240TX-C	TX40	78	25	8	86	O92194	P92320
921245TX-C	TX45	78	25	9	93	O92194	P92320
921250TX-C	TX50	78	25	10	98	O92194	P92320
921255TX-C	TX55	78	25	12	109	O92194	P92320
921260TX-C	TX60	78	25	14	122	O92194	P92320
921270TX-C	TX70	78	25	16	148	O92194	P92320



**TT SERIES** Impact Sets available

**MODULAR TOOL CONTROL SYSTEM**

**PAGE 63**

**FOAM SERIES** Impact Sets available

**MODULAR TOOL CONTROL SYSTEM**

**PAGE 129**

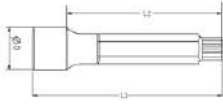

### 1/2" XZN IMPACT SOCKET

- DIN standard design for use with a retaining pin and ring
- Chrome molybdenum for use with power tools
- Black phosphate finish for easy identification as an impact socket accessory
- Ring and pin fixing hole on the female end to secure the socket
- Designed for use with fastenings with a multi point XZN type hole
- Supplied with a metal socket clip for use with a socket rail

ITEM ID:	Size	L mm	L2 mm	D mm	Weight g	Retaining Ring	Retaining Pin
921814	14	43	23	25	73	O92194	P92320
921816	16	43	23	25	77	O92194	P92320
921817	17	43	23	25	90	O92194	P92320
921818	18	43	23	25	90	O92194	P92320
923814	14	78	53	25	127	O92194	P92320
923816	16	78	53	25	134	O92194	P92320
923817	17	78	53	25	150	O92194	P92320
923818	18	78	53	25	151	O92194	P92320



### 1/2" TORQUE STICK

- Designed for tightening wheel nuts to a pre-set torque using an air gun
- The bar absorbs the excess power of the gun once the torque is reached
- Ensures uniform tightening of the wheel nuts
- Supplied with a metal socket clip for use with a socket rail

ITEM ID:	Drive	Torque Nm	Length mm	Retaining Ring	Retaining Pin
923090	1/2"	90	200	O92194	P92320
923110	1/2"	110	200	O92194	P92320
923120	1/2"	120	200	O92194	P92320
923140	1/2"	140	200	O92194	P92320

### 3/4" DRIVE IMPACT SOCKETS

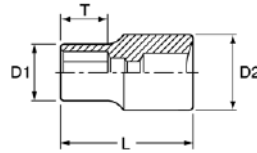

### 3/4" IMPACT SOCKET DIN METRIC

- DIN standard design for use with a retaining pin and ring
- Chrome molybdenum for use with power tools
- Black phosphate finish for easy identification as an impact socket accessory
- Ring and pin fixing hole on the female end to secure the socket

ITEM ID:	Size mm	L mm	T(min) mm	D1 mm	D2 mm	Retaining Ring	Retaining Pin
940519-C	19	50	13	33	44	O95036	P90435
940521-C	21	50	15	35	44	O95036	P90435
940522-C	22	50	15	37	44	O95036	P90435
940523-C	23	50	16	38	44	O95036	P90435
940524-C	24	50	16	39	44	O95036	P90435
940527-C	27	54	19	43	44	O95036	P90435
940528-C	28	54	19	44	44	O95036	P90435
940530-C	30	54	21	47	44	O95036	P90435
940532-C	32	56	22	48	44	O95036	P90435
940533-C	33	56	22	51	44	O95036	P90435
940534-C	34	56	22	52	44	O95036	P90435
940536-C	36	56	25	54	44	O95036	P90435
940538-C	38	58	25	57	44	O95036	P90435
940540-C	40	58	25	58	44	O95036	P90435
940541-C	41	58	27	60	44	O95036	P90435
940546-C	46	63	30	67	44	O95036	P90435
940550-C	50	68	30	71	44	O95036	P90435





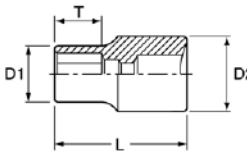

**3/4" IMPACT SOCKET DIN AF**

- DIN standard design for use with a retaining pin and ring
- Chrome molybdenum for use with power tools
- Black phosphate finish for easy identification as an impact socket accessory
- Ring and pin fixing hole on the female end to secure the socket to the air gun
- Supplied with a metal socket clip for use with a socket rail

ITEM ID:	Size AF	L mm	T(min) mm	D1 mm	D2 mm	Retaining Ring	Retaining Pin
940122	11/16"	51	14	29.5	41.4	O95036	P90435
940124	3/4"	51	14	32	41.4	O95036	P90435
940126	13/16"	51	14	35	41.4	O95036	P90435
940128	7/8"	51	14	36	41.4	O95036	P90435
940130	15/16"	51	16.5	38.5	41.4	O95036	P90435
940132	1"	53	16.5	40	41.4	O95036	P90435
940134	1-1/16"	53	20	42.5	44	O95036	P90435
940136	1-1/8"	53	20	44	44	O95036	P90435
940138	1-3/16"	53	20	46	44	O95036	P90435
940140	1-1/4"	57	21	48.5	44	O95036	P90435
940142	1-5/16"	57	21	50	44	O95036	P90435
940144	1-3/8"	57	21	52.5	44	O95036	P90435
940146	1-7/16"	57	21	53.5	44	O95036	P90435
940148	1-1/2"	57	22	56	44	O95036	P90435
940150	1-9/16"	58	22	58.5	44	O95036	P90435
940152	1-5/8"	58	22	60	44	O95036	P90435
940154	1-11/16"	62	25	63.5	44	O95036	P90435
940156	1-3/4"	62	25	64.5	44	O95036	P90435
940160	1-7/8"	68	30	68	44	O95036	P90435
940162	1-15/16"	68	30	70	44	O95036	P90435
940164	2"	68	30	71	44	O95036	P90435
940166	2-1/16"	71	32	73	54	O95046	P90445
940168	2-1/8"	71	32	75.5	54	O95046	P90445
940170	2-3/16"	71	32	77.5	54	O95046	P90445
940172	2-1/4"	73	34	80	54	O95046	P90445
940174	2-5/16"	73	34	81	54	O95046	P90445
940176	2-3/8"	73	34	83	54	O95046	P90445

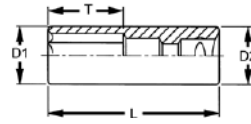

**3/4" DEEP IMPACT SOCKET DIN METRIC**

- DIN standard design for use with a retaining pin and ring
- Chrome molybdenum for use with power tools
- Black phosphate finish for easy identification as an impact socket accessory
- Ring and pin fixing hole on the female end to secure the socket to the air gun

ITEM ID:	Size mm	L mm	T(min) mm	D1 mm	D2 mm	Retaining Ring	Retaining Pin
940619-C	19	95	31	33	44	O95036	P90435
940621-C	21	95	31	35	44	O95036	P90435
940622-C	22	95	31	37	44	O95036	P90435
940623-C	23	95	31	38	44	O95036	P90435
940624-C	24	95	31	39	44	O95036	P90435
940627-C	27	95	31	43	44	O95036	P90435
940630-C	30	95	33	47	44	O95036	P90435
940632-C	32	95	33	49	44	O95036	P90435
940633-C	33	95	34	51	44	O95036	P90435
940634-C	34	95	34	52	44	O95036	P90435
940636-C	36	95	36	54	44	O95036	P90435
940638-C	38	95	36	57	44	O95036	P90435
940641-C	41	95	36	58	44	O95036	P90435
940646-C	46	95	36	67	44	O95036	P90435
940650-C	50	95	36	71	44	O95036	P90435

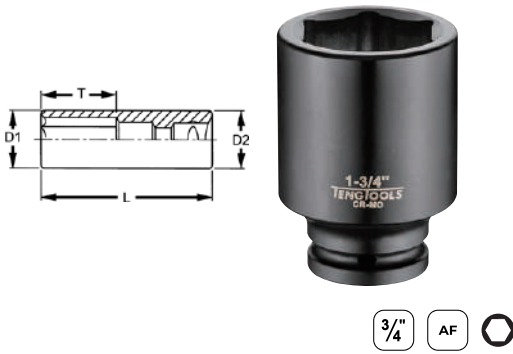

### 3/4" DEEP IMPACT SOCKET DIN AF

- DIN standard design for use with a retaining pin and ring
- Chrome molybdenum for use with power tools
- Black phosphate finish for easy identification as an impact socket accessory
- Ring and pin fixing hole on the female end to secure the socket
- Supplied with a metal socket clip for use with a socket rail

ITEM ID:	Size AF	L mm	T(min) mm	D1 mm	D2 mm	Retaining Ring	Retaining Pin
940224	3/4"	90	26	32	41.4	O95034	P90433
940226	13/16"	90	26	35	41.4	O95034	P90433
940228	7/8"	90	26	36	41.4	O95034	P90433
940230	15/16"	90	26	38.5	41.4	O95034	P90433
940232	1"	90	26	40	41.4	O95034	P90433
940234	1-1/16"	90	28	42.5	44	O95036	P90435
940236	1-1/8"	90	28	44	44	O95036	P90435
940238	1-3/16"	90	28	46	44	O95036	P90435
940240	1-1/4"	90	28	48.5	44	O95036	P90435
940242	1-5/16"	90	30	50	44	O95036	P90435
940244	1-3/8"	90	30	52.5	44	O95036	P90435
940246	1-7/16"	90	30	53.5	44	O95036	P90435
940248	1-1/2"	90	34	56	44	O95036	P90435
940250	1-9/16"	90	34	58.5	44	O95036	P90435
940252	1-5/8"	90	34	60	44	O95036	P90435
940254	1-11/16"	90	34	63.5	44	O95036	P90435
940256	1-3/4"	90	34	64.5	44	O95036	P90435
940258	1-13/16"	90	34	66	44	O95036	P90435
940260	1-7/8"	90	34	68	44	O95036	P90435

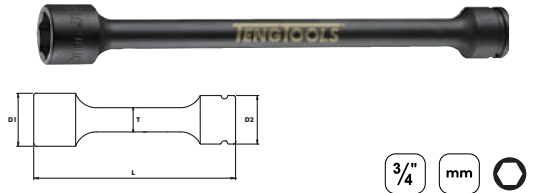

### 3/4" EXTRA LONG IMPACT SOCKET METRIC

- Ideal for reaching wheel nuts on recessed truck wheels
- DIN standard design for use with a retaining pin and ring
- Chrome molybdenum for use with power tools
- Black phosphate finish for easy identification as an impact socket accessory
- Ring and pin fixing hole on the female end to secure the socket

ITEM ID:	Size mm	L mm	T(min) mm	D1 mm	D2 mm	Retaining Ring	Retaining Pin
940732-C	32	400	22	48	44	O95036	P90435



### 3/4" HEX IMPACT SOCKET DIN METRIC

- DIN standard design for use with a retaining pin and ring
- Chrome molybdenum for use with power tools
- Black phosphate finish for easy identification as an impact socket accessory
- Ring and pin fixing hole on the female end to secure the socket
- Designed for use with fastenings with a hexagon hole
- Use with in-hex screws or grub screws
- Supplied with a metal socket clip for use with a socket rail

ITEM ID:	Size mm	L mm	D1 mm	Weight g	Retaining Ring	Retaining Pin
941519-C	19	90	44	600	O95036	P90435
941522-C	22	90	44	600	O95036	P90435
941524-C	24	90	44	600	O95036	P90435

1" DRIVE IMPACT SOCKETS

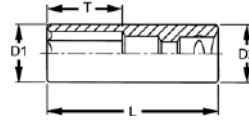
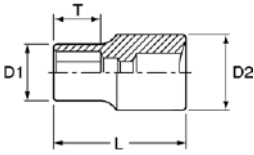

1" DEEP IMPACT SOCKET DIN METRIC

- DIN standard design for use with a retaining pin and ring
- Chrome molybdenum for use with power tools
- Black phosphate finish for easy identification as an impact socket accessory
- Ring and pin fixing hole on the female end to secure the socket

1" IMPACT SOCKET DIN METRIC

- DIN standard design for use with a retaining pin and ring
- Chrome molybdenum for use with power tools
- Black phosphate finish for easy identification as an impact socket accessory
- Ring and pin fixing hole on the female end to secure the socket

ITEM ID:	Size mm	L mm	T(min) mm	D1 mm	D2 mm	Retaining Ring	Retaining Pin
910524	24	58	18	41	54	O97045	P90545
910527	27	58	20	46	54	O97045	P90545
910530	30	60	21	49	54	O97045	P90545
910532	32	60	21	52	54	O97045	P90545
910533	33	60	21	53	54	O97045	P90545
910534	34	60	21	55	54	O97045	P90545
910536	36	65	30	56	54	O97045	P90545
910538	38	65	30	59	54	O97045	P90545
910541	41	67	30	63	54	O97045	P90545
910546	46	74	40	69	54	O97045	P90545
910550	50	80	43	74	54	O97045	P90545
910555	55	84	43	80	54	O97045	P90545
910560	60	87	46	86	54	O97045	P90545
910565	65	90	49	92	54	O97045	P90545
910570	70	96	51	99	54	O97045	P90545
910575	75	98	52	104	54	O97051	P90551
910580	80	100	52	109	86	O910075	P90675
910585	85	100	52	115	86	O910075	P90675
910590	90	100	55	119	86	O910075	P90675
910595	95	100	55	130	86	O910075	P90675

ITEM ID:	Size mm	L mm	T(min) mm	D1 mm	D2 mm	Retaining Ring	Retaining Pin
910627R	27	100	50	46	54	O97045	P90545
910630R	30	100	50	50	54	O97045	P90545
910632R	32	100	50	52	54	O97045	P90545
910633R	33	100	50	53	54	O97045	P90545

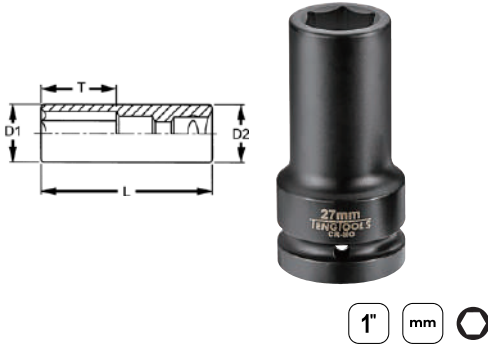

**1" DEEP THINWALL IMPACT SOCKET DIN METRIC**

- Thin wall design for reaching in to recesses
- DIN standard design for use with a retaining pin and ring
- Chrome molybdenum for use with power tools
- Black phosphate finish for easy identification as an impact socket accessory
- Ring and pin fixing hole on the female end to secure the socket

ITEM ID:	Size mm	L mm	T(min) mm	D1 mm	D2 mm	Retaining Ring	Retaining Pin
910624	24	100	28	38	54	O97045	P90545
910627	27	100	28	43	54	O97045	P90545
910628	28	100	28	43	54	O97045	P90545
910630	30	100	42	45	54	O97045	P90545
910632	32	100	45	47	54	O97045	P90545
910633	33	100	45	49	54	O97045	P90545
910636	36	100	66	52	54	O97045	P90545

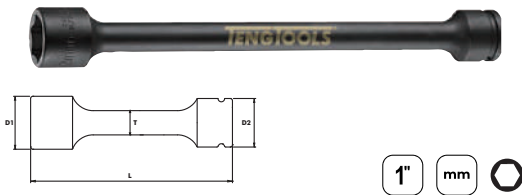

**1" EXTRA LONG IMPACT SOCKET METRIC**

- Ideal for reaching wheel nuts on recessed truck wheels
- DIN standard design for use with a retaining pin and ring
- Chrome molybdenum for use with power tools
- Black phosphate finish for easy identification as an impact socket accessory
- Ring and pin fixing hole on the female end to secure the socket

ITEM ID:	Size mm	L mm	T(min) mm	D1 mm	D2 mm	Retaining Ring	Retaining Pin
910732	32	400	28	48	54	O97045	P90545

**1-1/2" DRIVE IMPACT SOCKETS**

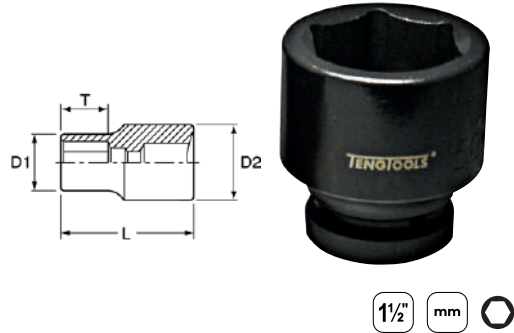

**1-1/2" IMPACT SOCKET DIN METRIC**

- DIN standard design for use with a retaining pin and ring
- Chrome molybdenum for use with power tools
- Black phosphate finish for easy identification as an impact socket accessory
- Ring and pin fixing hole on the female end to secure the socket

ITEM ID:	Size mm	L mm	T(min) mm	D1 mm	D2 mm	Retaining Ring	Retaining Pin
912041	41	80	27	69	86	O910075	P90675
912046	46	84	29	75	86	O910075	P90675
912050	50	87	30	80	86	O910075	P90675
912055	55	90	32	86	86	O910075	P90675
912060	60	95	35	91	86	O910075	P90675
912065	65	100	38	100	86	O910075	P90675
912070	70	105	40	104	86	O910075	P90675
912075	75	105	42	105	86	O910075	P90675
912080	80	110	46	116	86	O910075	P90675
912085	85	110	46	123	86	O910075	P90675
912090	90	112	48	129	86	O910075	P90675
912095	95	112	48	136	127	O9100115	P906110
912100	100	115	50	142	127	O9100115	P906110
912105	105	120	52	148	127	O9100115	P906110
912110	110	124	54	154	127	O9100115	P906110
912115	115	128	56	161	127	O9100115	P906110
912120	120	132	58	167	127	O9100115	P906110
912125	125	136	60	173	127	O9100115	P906110
912130	130	140	60	180	127	O9100115	P906110

# TORQUE TOOLS

## Make the professional choice

TengTools torque wrenches have become an industry standard. Whether you choose the classic version that has been a favourite for many years or the new P-Series range designed for the industrial and maintenance sectors you are guaranteed quality, accuracy and reliability as standard.



### TORQUE WRENCH

Click type mechanism to signal when the required torque is reached

Equipped with an in-built angular gauge for when tightening at specific angle is required

Reversible 24 teeth ratchet mechanism in according to DIN3122 giving 15° increments

Switch for changing between left and right-hand action. Designed to torque right hand only. Bi-Directional models are available.

Scale in Nm & ft/lb

Twist locking to ensure the set torque is maintained

Accurate to +/- 4% and conforms to ISO6789



### TORQUE WRENCH PLUS

Quick release 72 teeth ratchet mechanism with twist reverse manufactured to DIN3122

Compact head for easier use in confined spaces

Click type mechanism to signal when the required torque is reached

Industrial quality grade steel tube for added stability

Ergonomic bi-material grip for maximum comfort when in use

Easy to read Nm scale that is simple to adjust

Locking button to ensure the set torque is securely maintained

Hanging facility which can be used together with a fall protection equipment

Accurate to +/- 4% and conforms to ISO6789



Get Organised™



1/4" DRIVE



1/4"

1/4" TORQUE SCREWDRIVER

- Slipper mechanism ensures that no torque is applied beyond the set torque
- Simple to adjust and easy to read Nm scale
- Push locking facility to ensure the set torque is maintained
- Accurate to +/- 6% and conforms to ISO6789 for assured accuracy
- Each torque wrench has it's own individual certification number
- Supplied in a handy storage case

ITEM ID:	Range Nm
1492TSD	1-5



1/4"



1/4" INSULATED TORQUE SCREWDRIVER 1-5NM

- Approved for live working up to 1,000 volts
- Torque screwdriver covering 1-5Nm for our VDE interchangeable blades
- Slipper mechanism ensures that no torque is applied beyond the set torque
- Simple to adjust and easy to read window Nm scale
- Push locking facility to ensure the set torque is maintained
- Accurate to +/- 6% and conforms to ISO6789 for assured reliability and accuracy
- Individually tested and certified at the time of manufacture
- Each torque wrench has it's own individual certification number for easier quality control management
- Design and manufactured to IEC 60900

ITEM ID:	Range Nm
1492TVSD	1-5



1/4"

1/4" TORQUE WRENCH

- Equipped with an in-built angular gauge for easier after tightening
- Click type mechanism to signal when the required torque is reached
- Additional ft/lb reference scale
- Marked to show the correct place where pressure should be applied
- Twist locking facility to ensure the set torque is maintained
- Reversible 24 teeth ratchet mechanism (DIN3122) giving 15° increments
- Designed to torque right hand (clockwise) fasteners
- Accurate to +/- 4% and conforms to ISO6789 for assured accuracy
- Each torque wrench has it's own individual certification number
- Supplied in a handy storage case

ITEM ID:	Updated	Range		Scale		L	W	H	Weight
	Cert	Nm	ft/lb	Nm	ft/lb	mm	mm	mm	g
1492AG-E	-	5-25	4-18	0.1	0.075	277	27.6	20.6	580
1492AG-CT	Y	5-25	4-18	0.1	0.075	277	27.6	20.6	580

3/8" DRIVE



3/8"

3/8" TORQUE WRENCH

- Equipped with an in-built angular gauge for easier after tightening
- Click type mechanism to signal when the required torque is reached
- Additional ft/lb reference scale
- Marked to show the correct place where pressure should be applied
- Twist locking facility to ensure the set torque is maintained
- Reversible 24 teeth ratchet mechanism (DIN3122) giving 15° increments
- Designed to torque right hand (clockwise) fasteners
- Accurate to +/- 4% and conforms to ISO6789 for assured accuracy
- Each torque wrench has it's own individual certification number
- Supplied in a handy storage case

ITEM ID:	Updated	Range		Scale		L	W	H	Weight
	Cert	Nm	ft/lb	Nm	ft/lb	mm	mm	mm	g
3892AG-E1	-	5-25	4-18	0.5	0.369	277	27.6	20.6	580
3892AG1-CT	Y	5-25	4-18	0.5	0.369	277	27.6	20.6	580
3892AG-E3	-	20-110	15-81	0.5	0.369	368	35.9	27.7	580
3892AG3-CT	Y	20-110	15-81	0.5	0.369	368	35.9	27.7	580



3/8"

### 3/8" TORQUE WRENCH PLUS

- Click type mechanism to signal when the required torque is reached
- Simple to adjust and easy to read Nm scale
- Locking button to ensure the set torque is securely maintained
- Compact head for easier use in confined spaces
- Quick release 72 teeth ratchet mechanism with twist reverse (DIN3122)
- Designed to torque right hand (clockwise) fasteners
- Ergonomic bi-material grip for added comfort
- Marked to show the correct place where pressure should be applied
- Hanging facility which can be used together with a fall protection wire
- Accurate to +/- 4% and conforms to ISO6789 for assured accuracy
- Each torque wrench has it's own individual certification number
- Supplied in a handy storage case

ITEM ID:	Updated Cert	Range Nm	Scale Nm	L mm	W mm	H mm	Weight g
3892P060	-	12-60	0.5	380	36	36	930
3892P060-CT	Y	12-60	0.5	380	36	36	930
3892P100	-	20-100	0.5	410	36	36	960
3892P100-CT	Y	20-100	0.5	410	36	36	960



3/8"

### 3/8" DIGITAL BI-DIRECTIONAL TORQUE WRENCH

- Simple to use with 9 separate torque settings  
Can be pre-programmed for different torque tolerances before use  
Audio visual warning with an indicator light to ensure the correct torque  
Easy to read digital scale showing Nm, ft/lb, in/lb or kg/m readings
- Marked to show the correct place where pressure should be applied
- Reversible 45 teeth quick release ratchet mechanism (DIN3122)
- Suitable for use on clockwise and anti-clockwise fastenings
- Accurate to +/- 1% and conforms to ISO6789 for assured accuracy
- Each torque wrench has it's own individual certification number
- Uses standard AA batteries for easy replacement
- Supplied in a handy storage case

ITEM ID:	Updated Cert	Range		Scale		L mm	W mm	H mm	Weight g
		Nm	ft/lb	Nm	ft/lb				
3892D100	-	10-100	7-75	0.1	0.1	457	42.5	46.5	904
3892D100-CT	Y	10-100	7-75	0.1	0.1	457	42.5	46.5	904



**TT**  
SERIES

Torque Sets available

**MODULAR TOOL CONTROL SYSTEM**



**PAGE 66**

**FOAM**  
SERIES

Torque Sets available

**MODULAR TOOL CONTROL SYSTEM**



**PAGE 131**



1/2" DRIVE



1/2"

1/2" TORQUE WRENCH

- Equipped with an in-built angular gauge for easier after tightening
- Click type mechanism to signal when the required torque is reached
- Additional ft/lb reference scale
- Marked to show the correct place where pressure should be applied
- Twist locking facility to ensure the set torque is maintained
- Reversible 24 teeth ratchet mechanism (DIN3122) giving 15° increments
- Designed to torque right hand (clockwise) fasteners
- Accurate to +/- 4% and conforms to ISO6789 for assured accuracy
- Each torque wrench has it's own individual certification number
- Supplied in a handy storage case

ITEM ID:	Updated Cert	Range		Scale		L mm	W mm	H mm	Weight g
		Nm	ft/lb	Nm	ft/lb				
1292AG-EP	-	40-210	30-150	1.0	0.738	465	46.9	33.4	1340
1292AGP-CT	Y	40-210	30-150	1.0	0.738	465	46.9	33.4	1340
1292AG-E4	-	70-350	50-250	1.0	0.738	632	47.1	37.1	2400
1292AG4-CT	Y	70-350	50-250	1.0	0.738	632	47.1	37.1	2400



1/2"

1/2" BI-DIRECTIONAL TORQUE WRENCH

- Equipped with an in-built angular gauge for easier after tightening
- Click type mechanism to signal when the required torque is reached
- Additional ft/lb reference scale
- Marked to show the correct place where pressure should be applied
- Twist locking facility to ensure the set torque is maintained
- Reversible 24 teeth ratchet mechanism (DIN3122) giving 15° increments
- Designed to torque right hand (clockwise) fasteners
- Accurate to +/- 4% and conforms to ISO6789 for assured accuracy
- Each torque wrench has it's own individual certification number
- Supplied in a handy storage case

ITEM ID:	Updated Cert	Range		Scale		L mm	W mm	H mm	Weight g
		Nm	ft/lb	Nm	ft/lb				
1292AG-ER	-	40-210	30-150	1.0	0.738	465	46.9	33.4	1340
1292AGR-CT	Y	40-210	30-150	1.0	0.738	465	46.9	33.4	1340
1292AG-E4R	-	70-350	50-250	1.0	0.738	632	47.1	37.1	2400
1292AG4R-CT	Y	70-350	50-250	1.0	0.738	632	47.1	37.1	2400





1/2"

### 1/2" TORQUE WRENCH PLUS

- Click type mechanism to signal when the required torque is reached
- Simple to adjust and easy to read Nm scale
- Locking button to ensure the set torque is securely maintained
- Compact head for easier use in confined spaces
- Quick release 72 teeth ratchet mechanism with twist reverse (DIN3122)
- Designed to torque right hand (clockwise) fasteners
- Ergonomic bi-material grip for added comfort
- Marked to show the correct place where pressure should be applied
- Hanging facility which can be used together with a fall protection wire
- Accurate to +/- 4% and conforms to ISO6789 for assured accuracy
- Each torque wrench has it's own individual certification number
- Supplied in a handy storage case

ITEM ID:	Updated	Range	Scale	L	W	H	Weight
	Cert	Nm	Nm				
1292P100	-	20-100	0.5	410	36	36	965
1292P100-CT	Y	20-100	0.5	410	36	36	965
1292P200	-	40-200	1.0	490	42	44	1465
1292P200-CT	Y	40-200	1.0	490	42	44	1465
1292P320	-	60-320	2.0	560	42	44	1645
1292P320-CT	Y	60-320	2.0	560	42	44	1645



1/2"

### DIGITAL TORQUE WRENCH

- Simple to use with 9 separate torque settings  
Can be pre-programmed for different torque tolerances before use  
Audio visual warning with an indicator light to ensure the correct torque  
Easy to read digital scale showing Nm, ft/lb, in/lb or kg/m readings
- Marked to show the correct place where pressure should be applied
- Reversible 45 teeth quick release ratchet mechanism (DIN3122)
- Suitable for use on clockwise and anti-clockwise fastenings
- Accurate to +/- 1% and conforms to ISO6789 for assured accuracy
- Each torque wrench has it's own individual certification number
- Uses standard AA batteries for easy replacement
- Supplied in a handy storage case

ITEM ID:	Updated	Range	Scale	L	W	H	Weight		
	Cert	Nm	ft/lb					Nm	ft/lb
1292D200	-	20-200	30-150	0.1	0.1	548	42.5	46.5	1200
1292D200-CT	Y	20-200	30-150	0.1	0.1	548	42.5	46.5	1200



## Do's and Don't's of Torque Wrenches

### DO'S

- **Use carefully:** Torque wrenches are a measuring instrument and need to be treated with care
- **Reset torque:** After use set the torque to its lowest setting. If you don't over time the springs inside the wrench can lose their normal tension
- **Store Safely:** All torque instruments should be stored in their original case
- **Keep wrench maintained:** Torque wrenches should be cleaned and calibrated on a yearly basis

### DONT'S

- **Use as a power bar:** Torque wrenches should never be used as a power bar to shift stubborn fastenings
- **Abuse your wrench:** Do not drop your torque wrench or overload the wrench with a pipe extension
- **Store in conditions that lead to corrosion:** Avoid any storage locations that are subject to high or low temperatures and high humidity
- **Use without PPE:** We recommend safety glasses when using any torque wrench or torque product

**3/4" DRIVE**



3/4"

**3/4" TORQUE WRENCH**

- Equipped with an in-built angular gauge for easier after tightening
- Click type mechanism to signal when the required torque is reached
- Additional ft/lb reference scale
- Marked to show the correct place where pressure should be applied
- Twist locking facility to ensure the set torque is maintained
- Reversible 24 teeth ratchet mechanism (DIN3122) giving 15° increments
- Designed to torque right hand (clockwise) fasteners
- Accurate to +/- 4% and conforms to ISO6789 for assured accuracy
- Each torque wrench has it's own individual certification number
- Supplied in a handy storage case

ITEM ID:	Updated Cert	Range		Scale		L mm	W mm	H mm	Weight g
		Nm	ft/lb	Nm	ft/lb				
3492AG-E	-	65-450	48-330	5.0	3.69	850	72.5	53.5	3840
3492AG-CT	Y	65-450	48-330	5.0	3.69	850	72.5	53.5	3840
3492AG-E1	-	140-700	100-500	2.5	1.85	1065	72.5	53.5	5970
3492AG1-CT	Y	140-700	100-500	2.5	1.85	1065	72.5	53.5	5970
3492AG-E2	-	140-980	100-700	3.5	2.58	1213	72.5	53.5	6550
3492AG2-CT	Y	140-980	100-700	3.5	2.58	1213	72.5	53.5	6550



3/4"

**3/4" BI-DIRECTIONAL TORQUE WRENCH**

- Equipped with an in-built angular gauge for easier after tightening
- Click type mechanism to signal when the required torque is reached
- Additional ft/lb reference scale
- Marked to show the correct place where pressure should be applied
- Twist locking facility to ensure the set torque is maintained
- Reversible 24 teeth ratchet mechanism (DIN3122) giving 15° increments
- Designed to torque right hand (clockwise) fasteners
- Accurate to +/- 4% and conforms to ISO6789 for assured accuracy
- Each torque wrench has it's own individual certification number
- Supplied in a handy storage case

ITEM ID:	Updated Cert	Range		Scale		L mm	W mm	H mm	Weight g
		Nm	ft/lb	Nm	ft/lb				
3492AG-ER	-	65-450	48-330	5.0	3.69	850	72.5	53.5	3840
3492AGR-CT	Y	90-450	70-350	5.0	3.69	850	72.5	53.5	3840





3/4"

### 3/4" TORQUE WRENCH PLUS

- Click type mechanism to signal when the required torque is reached
- Simple to adjust and easy to read Nm scale
- Locking button to ensure the set torque is securely maintained
- Compact head for easier use in confined spaces
- Quick release 72 teeth ratchet mechanism with twist reverse (DIN3122)
- Designed to torque right hand (clockwise) fasteners
- Ergonomic bi-material grip for added comfort
- Marked to show the correct place where pressure should be applied
- Hanging facility which can be used together with a fall protection wire
- Accurate to +/- 4% and conforms to ISO6789 for assured accuracy
- Each torque wrench has it's own individual certification number
- Supplied in a handy storage case

ITEM ID:	Updated Cert	Range Nm	Scale Nm	L mm	W mm	H mm	Weight g
3492P500	-	100-500	2.5	790	68	62	3100
3492P500-CT	Y	100-500	2.5	790	68	62	3100

### TORQUE WRENCH SERVICE KITS

- Includes a set of replacement parts for the ratchet mechanism

ITEM ID:	Drive	Service Kit For:
1492AGERK	1/4"	1492AG-E
3892AG1RK	3/8"	3892AG-E1
3892AG3RK	3/8"	3892AG-E3
3892P060RK-1	3/8"	3892P060, 3892P100
DTQ100RK	3/8"	3892D100
1292AGERK	1/2"	1292AG-E, 1292AG-EP, & Pre Set Range
1292AGERRK	1/2"	1292AG-ER
1292AG4RK	1/2"	1292AG-E4
1292AG4RRK	1/2"	1292AG-E4R
1292P100RK-1	1/2"	1292P100
1292P200RK-1	1/2"	1292P200
DTQ200RK	1/2"	1292D200
3492AGERRK	3/4"	3492AG-ER
3492AGERK	3/4"	3492AG-E, 3492AG-E1, 3492AG-E2
3492P500RK-1	3/4"	3492P500



## TT SERIES

Torque Sets available

### MODULAR TOOL CONTROL SYSTEM



PAGE 66

## FOAM SERIES

Torque Sets available

### MODULAR TOOL CONTROL SYSTEM



PAGE 131

ACCESSORIES



INSERT TORQUE WRENCHES

- Click type mechanism to signal when the required torque is reached
- Simple to adjust and easy to read Nm scale
- Locking button to ensure the set torque is securely maintained
- Compact head for easier use in confined spaces
- Quick release 72 teeth ratchet mechanism with twist reverse (DIN3122)
- Designed to torque right hand (clockwise) fasteners
- Ergonomic bi-material grip for added comfort
- For use with the relevant insert torque tools
- Marked to show the correct place where pressure should be applied
- Hanging facility which can be used together with a fall protection wire
- Accurate to +/- 4% and conforms to ISO6789 for assured accuracy
- Each torque wrench has it's own individual certification number
- Supplied in a handy storage case

ITEM ID:	Head Size	Range Nm	Scale Nm	L mm	W mm	H mm	Weight g
1292P912	9x12	20-100	0.5	400	36	36	862
1292P418	14x18	40-200	1.0	560	42	44	1096

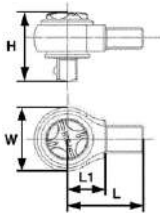

INSERT RATCHET HEADS

- 45 teeth ratchet
- Designed for use with the P-SERIES insert torque wrenches
- Use with 3/8", 1/2", & 3/4" drive sockets & accessories
- Satin finish

ITEM ID:	Fitting mm	W mm	H mm	L mm	L1 mm	Weight g
3892CQ100R	9 x 12	35	36.5	36.3	20	150
1292CQ200R	14 x 18	42.5	46	70.5	24.4	288
3492CQ500R	14 x 18	68.8	69.8	98	36	988

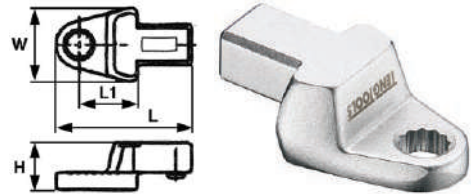

RING ENDED INSERT SPANNERS

- 9 x 12mm rectangular fitting
- 12 point bi-hexagon ring end for easier alignment
- For use with quick change open end torque wrenches
- Ideal for use in confined spaces
- Easy to change
- Satin finish chrome vanadium steel

ITEM ID:	Size mm	Fitting mm	W mm	H mm	L mm	L1 mm	g
690710	10	9 x 12	26.5	16	45	18	52
690711	11	9 x 12	26.5	16	45	18	50
690712	12	9 x 12	26.7	16	46	18	48
690713	13	9 x 12	27.2	16	49	20	60
690714	14	9 x 12	27	18	50	20	64
690715	15	9 x 12	27	18	50	20	64
690716	16	9 x 12	27	18	50	20	62
690717	17	9 x 12	28.6	18	54	22	74
690718	18	9 x 12	28.6	18	54	22	74
690719	19	9 x 12	28.6	18	54	22	68



Recalculate new torque setting if required:

$$\text{New Torque} = P \times L_n / L_e$$

- P = Desired Torque
- L<sub>n</sub> = Normal Length (L1)
- L<sub>e</sub> = Extended Length

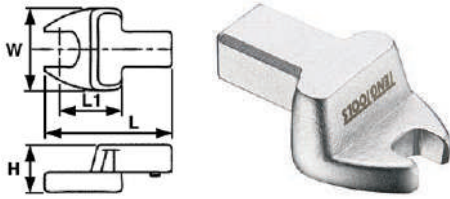

**OPEN ENDED INSERT SPANNERS**

- 9 x 12mm rectangular fitting
- For use with quick change open end torque wrenches
- Ideal for use in confined spaces
- Easy to change
- Satin finish chrome vanadium steel

ITEM ID:	Size mm	Fitting mm	W mm	H mm	L mm	LI mm	g
690510	10	9 x 12	30	15	39	18	42
690511	11	9 x 12	30	15	39	18	43
690512	12	9 x 12	30	16	40	18	48
690513	13	9 x 12	30	16	42	20	52
690514	14	9 x 12	35	17	42	20	59
690515	15	9 x 12	35	17	43	20	59
690516	16	9 x 12	38	18	43	20	67
690517	17	9 x 12	38	18	44	20	67
690518	18	9 x 12	42	18	46	22	75
690519	19	9 x 12	42	18	46	22	75

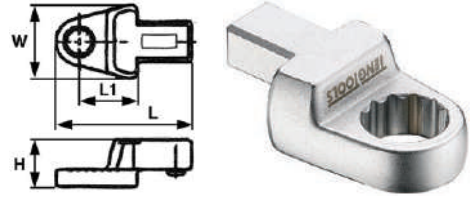

**RING ENDED INSERT SPANNERS**

- 12 point bi-hexagon ring end for easier alignment to the fastening
- 14 x 18mm rectangular fitting
- For use with quick change open end torque wrenches
- Ideal for use in confined spaces
- Easy to change
- Satin finish chrome vanadium steel

ITEM ID:	Size mm	Fitting mm	W mm	H mm	L mm	LI mm	g
690813	13	14 x 18	38	22	72	32	200
690814	14	14 x 18	38	22	72	32	200
690815	15	14 x 18	38	22	73	32	194
690816	16	14 x 18	38	24	73	32	204
690817	17	14 x 18	38	24	73	32	194
690818	18	14 x 18	44	24	75	32	234
690819	19	14 x 18	44	24	75	32	230
690821	21	14 x 18	41	26	76	32	236
690822	22	14 x 18	42	25	77	32	250
690824	24	14 x 18	42	26	78	32	254
690826	26	14 x 18	42	26	78	32	240
690827	27	14 x 18	43.4	27	82	34	280
690829	29	14 x 18	43.3	28	85	36	306
690830	30	14 x 18	47.3	28	87	36	328
690832	32	14 x 18	47.3	29	87	36	312
690834	34	14 x 18	50	29	90	38	324
690836	36	14 x 18	52	29	91	38	316
690838	38	14 x 18	54.6	31	94	40	342
690840	40	14 x 18	54.6	30	93	40	367
690841	41	14 x 18	60	32	99	42	376
690842	42	14 x 18	60	32	99	42	376
690844	44	14 x 18	60	31	99	44	386
690846	46	14 x 18	64.8	32	103	42	396



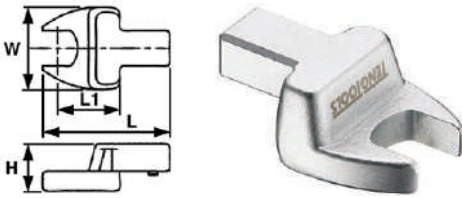

**OPEN ENDED INSERT SPANNERS**

- 14 x 18mm rectangular fitting
- For use with quick change open end torque wrenches
- Ideal for use in confined spaces
- Easy to change
- Satin finish chrome vanadium steel

ITEM ID:	Size mm	Fitting mm	W mm	H mm	L mm	LI mm	g
690613	13	14 x 18	35	21	63	32	148
690614	14	14 x 18	35	22	63	32	154
690615	15	14 x 18	35	23	64	32	154
690616	16	14 x 18	38	23	64	32	173
690617	17	14 x 18	38	23	64	32	173
690618	18	14 x 18	42	24	65	32	192
690619	19	14 x 18	42	25	65	32	193
690621	21	14 x 18	50	25	66	32	217
690622	22	14 x 18	53	26	66	32	222
690624	24	14 x 18	53	26	67	32	225
690626	26	14 x 18	60	27	70	33	273
690627	27	14 x 18	60	27	70	34	281
690629	29	14 x 18	66	28	74	36	312
690630	30	14 x 18	66	28	74	36	312
690632	32	14 x 18	66	29	77	38	322
690634	34	14 x 18	73	29	82	43	345
690636	36	14 x 18	73	29	82	42	368
690638	38	14 x 18	73	29	82	41	366
690640	40	14 x 18	82	29	83	42	383
690641	41	14 x 18	82	29	84	42	400
690642	42	14 x 18	82	29	83	42	410
690644	44	14 x 18	91	29	86	41	423
690646	46	14 x 18	91	29	86	43	436



**ANGULAR GAUGE**

- For measuring the degree of turn
- For use when after tightening of stretch bolts with torque wrenches that do not have an in-built angular gauge
- A static read off point, fixing magnet and a pair of angle scales make it possible to take a reading in most situations

Item ID: **TQAG**



3/4" 1"

**TORQUE MULTIPLIER 1:3**

- Ideal for tightening and loosening nuts and bolts where extra torque is required
- Supplied in a handy carrying case

ITEM ID:	Max Torque		Ratio	Diameter mm	Input Drive	Output Drive	Weight g
	Nm	ft/lb					
MP1400	1500	1100	1:3	69	1/2"	3/4"	2280
MP2700	3000	2200	1:3	92	3/4"	1"	4780



**TORQUE MULTIPLIER SUPPORT LEG**

- Fits on to the torque multiplier head or can be used as a support for the handle
- Designed to create a steady position for safer operation

ITEM ID:	Support Leg for:
MPSL01	MP1400
MPSL02	MP2700



3/4"

### TORQUE MULTIPLIER 1:10

- Ideal for tightening and loosening nuts and bolts where extra torque is required
- Supplied in a handy carrying case

ITEM ID:	Max Torque			Input Drive	Output Drive	Weight g
	Nm	ft/lb	Ratio			
MP91500	1500	1100	1:10	1/2"	3/4"	3180

### TORQUE MULTIPLIER SERVICE KITS

- Includes a set of replacement parts for the gear mechanism

ITEM ID:	Service Kit For:
MP1400RK-1	MP1400
MP2700RK-1	MP2700
MP91500RK	MP91500



### PRESET TORQUE SPANNER

- Pre-set open jaw torque spanners
- Ideal for air conditioning engineers
- Accurate to +/-4% and conforms to ISO6789

ITEM ID	Spanner Size	Pre-Set Torque	Weight
	mm	Nm	g
TQS018	17	18	396
TQS042	22	42	428
TQS055	26	55	546
TQS065	29	65	576



4 Pieces

### TORQUE SPANNER SET 4 PIECES

- Ideal for air conditioning engineers
- Set of 4 pre-set open jaw torque spanners
- Accurate to +/- 4% and conforms to ISO6789 for assured accuracy
- Individually tested and certified at the time of manufacturer
- Supplied in a handy carrying case

Spanner Size	Pre-Set Torque
mm	Nm
17	18
22	42
26	55
29	65

Item ID: **ACD01**





**DIGITAL TORQUE TESTER PRO**

- For checking the accuracy of torque wrenches
- Designed for checking clockwise torque readings
- Accurate to +/-1% of the measurement value
- Very easy to use with full instructions included
- Robust construction with fixing points for installation on a solid surface
- Supplied with a factory test certificate



ITEM ID	Plug Type	Range Nm	Depth mm	Width mm	Height mm	Weight g
TORQ99E	Europe	10-400	200	160	85	2500
TORQ99U	UK	10-400	200	160	85	2500
TORQ99A	Aus / NZ	10-400	200	160	85	2500



**DIGITAL TORQUE TESTER**

- For checking the accuracy of torque wrenches
- Designed for checking clockwise torque readings
- Accurate to +/-1% of the measurement value
- Very easy to use with full instructions included
- Robust construction with fixing points for installation on a solid surface
- Supplied with a factory test certificate

ITEM ID	Plug Type	Range Nm	Depth mm	Width mm	Height mm	Weight g
TORQ02	Europe	1.5-30	205	155	76	2940
TORQ03	Europe	7.5-150	205	155	76	3940
TORQ04	Europe	25.500	205	155	76	4060
TORQ05	Europe	50-1000	205	155	76	4060
TORQ02U	UK	1.5-30	205	155	76	2940
TORQ03U	UK	7.5-150	205	155	76	3940
TORQ04U	UK	25.500	205	155	76	4060
TORQ05U	UK	50-1000	205	155	76	4060
TORQ02A	Aus / NZ	1.5-30	205	155	76	2940
TORQ03A	Aus / NZ	7.5-150	205	155	76	3940
TORQ04A	Aus / NZ	25.500	205	155	76	4060
TORQ05A	Aus / NZ	50-1000	205	155	76	4060



### TORQUE TESTER STAND

- Designed for mounting the TORQ99 torque tester and the TORP01 printer
- Creates a stand alone torque testing work station
- A robust construction creates a good, stable working position
- It features a storage shelf and adjustable feet to ensure steadiness on uneven surfaces

ITEM ID	Depth mm	Width mm	Height mm	Weight g
TORQS01	570	340	950	1640



### TORQUE TESTER PRINTER

- For use together with the TengTools digital torque tester
- Enables a printed record of each reading
- Very easy to use with full instructions included

ITEM ID	Plug Type	Depth mm	Width mm	Height mm	Weight g
TORP01E	Europe	220	180	95	1840
TORP01U	UK	220	180	95	1840
TORP01A	Aus / NZ	220	180	95	1840



\*Torque wrench & socket not included

### TORQUE TESTER PRINTER AND STAND

- A complete torque test centre
- Creates a stand alone torque testing work station
- Designed for checking clockwise torque wrench readings
- Accurate to +/-1% of the measurement value
- The printer enables a record to be kept of each reading
- Very easy to use with full instructions included
- The stand has a robust construction to create a stable working position
- It features a storage shelf and adjustable feet to ensure steadiness on uneven surfaces

ITEM ID	Plug Type	Range Nm	Depth mm	Width mm	Height mm	Weight g
TORQ	Europe	10-400	570	340	950	4350
TORQU	UK	10-400	570	340	950	4350
TORQA	Aus / NZ	10-400	570	340	950	4350



# SPANNERS & WRENCHES

## Quality as standard

Our range has been developed over many years with DIN and ISO standards as the lowest benchmark when it comes to quality and size tolerances. This is a policy that has resulted in many top positions on best-buy lists in consumer and trade magazines. The range includes many different types of spanners for most application areas and personal taste.



### COMBINATION SPANNERS

High mechanical performance and optimized for increased accessibility complying with DIN and ISO standards

Manufactured and designed in accordance with DIN3113A in high grade chrome vanadium steel

Size clearly marked on the side of the spanner for easy & quick visibility

The ring head is offset 15° to facilitate use even on flat surfaces



TengTools "Hip Grip" feature means the contact surface grips on the flat surfaces of the nut or bolt rather than on the corner



### RATCHETING SPANNERS

'R' range contains a lever to quickly switch between left and right-hand action. With the 'RS' range you flip the spanner over to change ratcheting direction.

'R' range is offset at 15° for use against flat surfaces while the 'RS' range is straight to reach the nut flat



Get Organised™

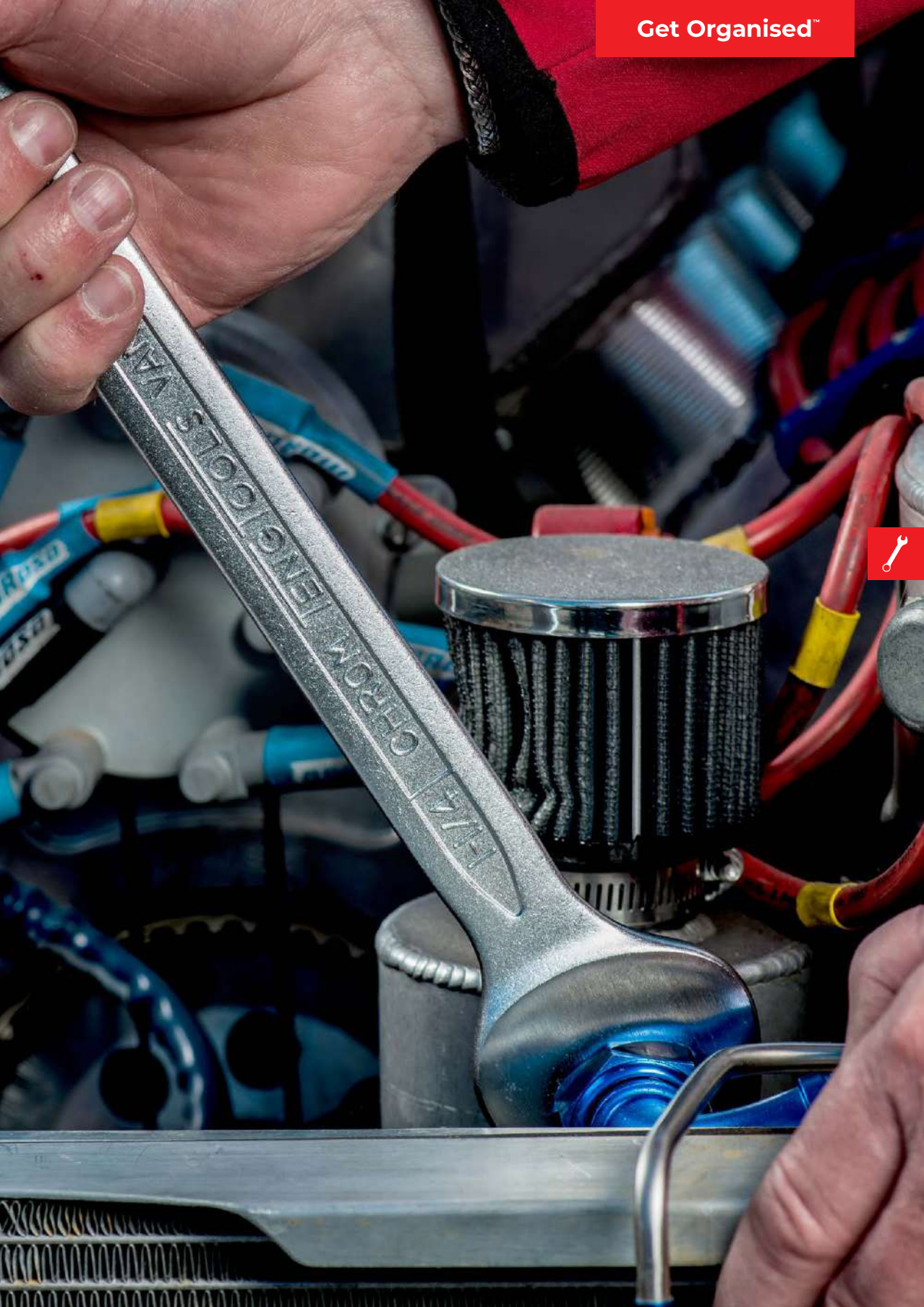

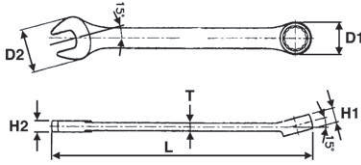

mm

**COMBINATION SPANNER METRIC**

- A ring and open ended spanner combined with the same size opening at each end
- Off set at 15° for easier use on flat surfaces
- TengTools hip grip design for contact with the flat side of the fastening
- Chrome vanadium satin finish
- Designed and manufactured to DIN3113A

ITEM ID:	Size mm	L mm	H1 mm	H2 mm	D1 mm	D2 mm	T mm	Weight g
6005055	5.5	95	4.1	3.5	8.9	13.6	2.4	11
600506	6	100	4.7	4	10.1	15.5	2.7	17
600507	7	110	5	4	11.5	17	2.8	23
600508	8	120	5.5	4.5	12.8	19.2	3	25
600509	9	130	5.9	4.5	14.2	21.2	3.3	28
600510	10	140	6.5	5	15.6	23.2	3.5	38
600511	11	150	6.9	5.4	16.9	25.3	3.7	47
600512	12	160	7.3	5.5	18.3	27.2	3.9	60
600513	13	170	7.8	5.9	19.7	29.4	4.1	68
600514	14	180	8.3	6.2	21.2	31.5	4.4	84
600515	15	190	8.6	6.4	22.5	33.2	4.6	98
600516	16	200	8.9	6.7	24	34.7	4.8	104
600517	17	210	9.3	6.9	25.3	36.5	5	124
600518	18	220	9.9	7.2	26.8	38.7	5.2	141
600519	19	230	10.5	7.4	28.1	40.7	5.4	158
600520	20	240	10.9	7.7	29.7	43.1	5.6	184
600521	21	250	11.3	8	31.3	44.8	5.7	209
600522	22	260	11.5	8.2	32.6	46.9	5.8	216
600523	23	270	11.8	8.4	34.2	48.3	5.9	258
600524	24	280	12.1	8.7	35.5	50.4	6	265
600525	25	290	12.5	8.9	36.9	52	6.2	296
600526	26	300	12.8	9.2	38.2	53.6	6.4	342
600527	27	310	13.1	9.4	39.6	55.7	6.6	385
600528	28	320	13.3	9.7	40.9	57.6	6.8	397
600529	29	330	13.5	9.9	42.3	59.7	7	435

ITEM ID:	Size mm	L mm	H1 mm	H2 mm	D1 mm	D2 mm	T mm	Weight g
600530	30	340	13.7	10.1	43.7	61.8	7.1	459
600532	32	360	14.3	10.4	46.4	65.8	7.3	527
600533	33	380	15	10.7	48.8	69.2	7.5	654
600534	34	380	15	10.7	48.8	69.2	7.5	674
600536	36	410	19.2	13.5	53.5	74	8	831
600538	38	430	20.4	15	56	77	9	967
600541	41	460	21.6	16	61	84	10	1257
600546	46	500	23	17	66	92	11	1693
600550	50	540	24.6	18	73	102	12	2048
600555	55	560	21.5	28	86	118	14.5	2800
600558	58	600	23.5	30	94	126	16	3900
600560	60	600	23.5	30	94	126	16	3900
600565	65	680	25	32	108	148	18	5600
600570	70	680	25	32	108	148	18	5800



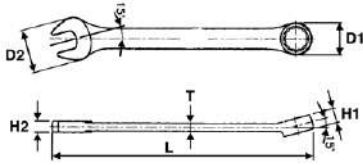

AF

**COMBINATION SPANNER AF**

- A ring and open ended spanner combined with the same size opening at each end
- Off set at 15° for easier use on flat surfaces
- TengTools hip grip design for contact with the flat side of the fastening
- Chrome vanadium satin finish
- Designed and manufactured to ASME B107.100

ITEM ID:	Size AF	L mm	H1 mm	H2 mm	D1 mm	D2 mm	T mm	Weight g
600108	1/4"	100	4.7	4	10.1	15.5	2.7	16
600110	5/16"	120	5.5	4.5	12.8	19.2	3	25
600112	3/8"	140	6.5	5	15.6	23.2	3.5	37
600114	7/16"	150	6.9	5.4	16.9	25.3	3.7	50
600116	1/2"	170	7.8	5.9	19.7	29.4	4.1	69
600118	9/16"	180	8.3	6.2	21.2	31.5	4.4	80
600120	5/8"	200	8.9	6.7	24	34.7	4.8	107
600122	11/16"	210	9.3	6.9	25.3	36.5	5	127
600124	3/4"	230	10.5	7.4	28.1	40.7	5.4	157
600126	13/16"	250	11.3	8	31.3	44.8	5.7	212
600128	7/8"	260	11.5	8.2	32.6	46.9	5.8	204
600130	15/16"	280	12.1	8.7	35.5	50.4	6	264
600132	1"	290	12.5	8.9	36.9	52	6.2	310
600134	1-1/16"	310	13.1	9.4	39.6	55.7	6.6	400
600136	1-1/8"	330	13.3	9.7	40.9	57.6	6.8	415
600140	1-1/4"	360	14.3	10.4	46.4	65.8	7.3	540
600142	1-5/16"	380	15	10.7	48.8	69.2	7.5	649
600144	1-3/8"	410	19.2	13.5	53	74	8	858
600146	1-7/16"	410	19.2	13.5	53	74	8	838
600148	1-1/2"	430	20.4	15	56	77	9	1002
600152	1-5/8"	460	21.6	16	61	84	10	1309
600156	1-3/4"	500	23	17	66	92	11	1595
600160	1-7/8"	540	24.6	18	73	102	12	2097



12 Pieces mm

**COMBINATION SPANNER 8-19 MM WALL RACK**

- Off set at 15° for easier use on flat surfaces
- TengTools hip grip design for contact with the flat side of the fastening
- Chrome vanadium satin finish
- Supplied with a wall rack for fixing to the wall or a workbench
- Designed and manufactured to DIN3113A

Combination Spanners:  
8, 9, 10, 11, 12, 13, 14, 15, 16, 17, 18, 19 mm

Item ID: **WRSPI2**



12 Pieces mm

**COMBINATION SPANNER SET 8-19 MM 12 PIECES**

- Off set at 15° for easier use on flat surfaces
- TengTools hip grip design for contact with the flat side of the fastening
- Chrome vanadium satin finish
- Designed and manufactured to DIN3113A

Combination Spanners:  
8, 9, 10, 11, 12, 13, 14, 15, 16, 17, 18, 19 mm

Item ID: **6512N**



12 Pieces mm

**COMBINATION SPANNER SET 8-22 MM 12 PIECES**

- Off set at 15° for easier use on flat surfaces
- TengTools hip grip design for contact with the flat side of the fastening
- Chrome vanadium satin finish
- Designed and manufactured to DIN3113A

Combination Spanners:

8, 9, 10, 11, 12, 13, 14, 15, 16, 17, 19, 22 mm

Item ID: **6512**



21 Pieces mm

**COMBINATION SPANNER SET 6-32 MM 21 PIECES**

- Off set at 15° for easier use on flat surfaces
- TengTools hip grip design for contact with the flat side of the fastening
- Chrome vanadium satin finish
- Designed and manufactured to DIN3113A

Combination Spanners:

6, 7, 8, 9, 10, 11, 12, 13, 14, 15, 16, 17, 18, 19, 20, 21, 22, 24, 27, 30, 32 mm

Item ID: **6521**



17 Pieces mm

**COMBINATION SPANNER SET 6-22 MM 17 PIECES**

- Off set at 15° for easier use on flat surfaces
- TengTools hip grip design for contact with the flat side of the fastening
- Chrome vanadium satin finish
- Designed and manufactured to DIN3113A

Combination Spanners:

6, 7, 8, 9, 10, 11, 12, 13, 14, 15, 16, 17, 18, 19, 20, 21, 22 mm

Item ID: **6517**



10 Pieces mm

**COMBINATION SPANNER SET 8-19 MM TOOL ROLL 10 PIECES**

- Off set at 15° for easier use on flat surfaces
- TengTools hip grip design for contact with the flat side of the fastening
- Chrome vanadium satin finish
- Supplied in a handy tool roll style wallet
- Designed and manufactured to DIN3113A

Combination Spanners:

8, 9, 10, 11, 12, 13, 14, 15, 17, 19 mm

Item ID: **6510MM**



12 Pieces mm

**COMBINATION SPANNER SET 8-19 MM  
TOOL ROLL 12 PIECES**

- Off set at 15° for easier use on flat surfaces
- TengTools hip grip design for contact with the flat side of the fastening
- Chrome vanadium satin finish
- Supplied in a handy tool roll style wallet
- Designed and manufactured to DIN3113A

Combination Spanners:

8, 9, 10, 11, 12, 13, 14, 15, 16, 17, 18, 19 mm

Item ID: **6512MM1**



17 Pieces mm

**COMBINATION SPANNER SET 6-22 MM  
TOOL ROLL 17 PIECES**

- Off set at 15° for easier use on flat surfaces
- TengTools hip grip design for contact with the flat side of the fastening
- Chrome vanadium satin finish
- Supplied in a handy tool roll style wallet
- Designed and manufactured to DIN3113A

Combination Spanners:

6, 7, 8, 9, 10, 11, 12, 13, 14, 15, 16, 17, 18, 19, 20, 21, 22 mm

Item ID: **6517MM**



15 Pieces mm

**COMBINATION SPANNER SET 5.5-19 MM  
TOOL ROLL 15 PIECES**

- Off set at 15° for easier use on flat surfaces
- TengTools hip grip design for contact with the flat side of the fastening
- Chrome vanadium satin finish
- Supplied in a handy tool roll style wallet
- Designed and manufactured to DIN3113A

Combination Spanners:

5.5, 6, 7, 8, 9, 10, 11, 12, 13, 14, 15, 16, 17, 18, 19 mm

Item ID: **6515MM**



12 Pieces mm

**COMBINATION SPANNER SET 20-32 MM  
TOOL ROLL 12 PIECES**

- Off set at 15° for easier use on flat surfaces
- TengTools hip grip design for contact with the flat side of the fastening
- Chrome vanadium satin finish
- Supplied in a handy tool roll style wallet
- Designed and manufactured to DIN3113A

Combination Spanners:

20, 21, 22, 23, 24, 25, 26, 27, 28, 29, 30, 32 mm

Item ID: **6512MM**





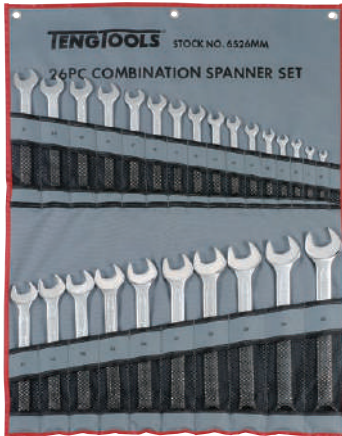

26 Pieces mm

**COMBINATION SPANNER SET 6-32 MM  
TOOL ROLL 32 PIECES**

- Off set at 15° for easier use on flat surfaces
- TengTools hip grip design for contact with the flat side of the fastening
- Chrome vanadium satin finish
- Supplied in a handy tool roll style wallet
- Designed and manufactured to DIN3113A

Combination Spanners:

6, 7, 8, 9, 10, 11, 12, 13, 14, 15, 16, 17, 18, 19, 20, 21, 22, 23, 24, 25, 26, 27, 28, 29, 30, 32 mm

Item ID: **6526MM**



7 Pieces mm

**COMBINATION SPANNER SET 33-50 MM  
TOOL ROLL 7 PIECES**

- Off set at 15° for easier use on flat surfaces
- TengTools hip grip design for contact with the flat side of the fastening
- Chrome vanadium satin finish
- Supplied in a handy tool roll style wallet
- Designed and manufactured to DIN3113A

Combination Spanners:

33, 34, 36, 38, 41, 46, 50 mm

Item ID: **6507JMM**



9 Pieces AF

**COMBINATION SPANNER SET 1/4"-3/4"  
TOOL ROLL 9 PIECES**

- Off set at 15° for easier use on flat surfaces
- TengTools hip grip design for contact with the flat side of the fastening
- Chrome vanadium satin finish
- Supplied in a handy tool roll style wallet
- Designed and manufactured to ASME B107.100

Combination Spanners:

1/4", 5/16", 3/8", 7/16", 1/2", 9/16", 5/8", 11/16", 3/4"

Item ID: **6509AF**



7 Pieces AF

**COMBINATION SPANNER SET 13/16"-1 1/4" TOOL ROLL 7 PIECES**

- Off set at 15° for easier use on flat surfaces
- TengTools hip grip design for contact with the flat side of the fastening
- Chrome vanadium satin finish
- Supplied in a handy tool roll style wallet
- Designed and manufactured to ASME B107.100

Combination Spanners:

13/16", 7/8", 15/16", 1", 1-1/16", 1-1/8", 1-1/4"

Item ID: **6507AF**



7 Pieces AF

**COMBINATION SPANNER SET 1 5/16"-1 7/8" TOOL ROLL 7 PIECES**

- Off set at 15° for easier use on flat surfaces
- TengTools hip grip design for contact with the flat side of the fastening
- Chrome vanadium satin finish
- Supplied in a handy tool roll style wallet
- Designed and manufactured to ASME B107.100

Combination Spanners:

1-5/16", 1-3/8", 1-7/16", 1-1/2", 1-5/8", 1-3/4", 1-7/8"

Item ID: **6507JAF**



10 Pieces mm

**COMBINATION SPANNER SET 8-19 MM PLASTIC HOLDER 10 PIECES**

- Off set at 15° for easier use on flat surfaces
- TengTools hip grip design for contact with the flat side of the fastening
- Chrome vanadium satin finish
- Supplied in a holder that can be used for storage or for mounting on a wall
- Designed and manufactured to DIN3113A

Combination Spanners:

8, 10, 11, 12, 13, 14, 15, 16, 17, 19 mm

Item ID: **6510A**

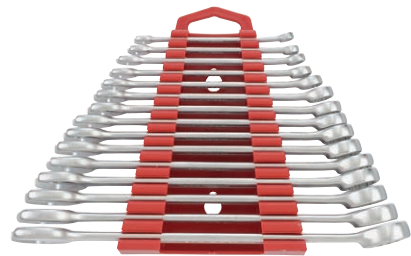

15 Pieces mm

**COMBINATION SPANNER SET 5.5-19 MM PLASTIC HOLDER 15 PIECES**

- Off set at 15° for easier use on flat surfaces
- TengTools hip grip design for contact with the flat side of the fastening
- Chrome vanadium satin finish
- Spanner holder can be used on it's own or it can be connected to set: 6512MMA
- Designed and manufactured to DIN3113A

Combination Spanners:

5.5, 6, 7, 8, 9, 10, 11, 12, 13, 14, 15, 16, 17, 18, 19 mm

Item ID: **6515MMA**

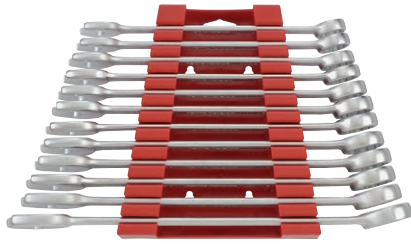

12 Pieces mm

**COMBINATION SPANNER SET 20-32 MM PLASTIC HOLDER 12 PIECES**

- Off set at 15° for easier use on flat surfaces
- TengTools hip grip design for contact with the flat side of the fastening
- Chrome vanadium satin finish
- Spanner holder can be used on it's own or it can be connected to sets: 6515MMA and/or 6507JMMA
- Designed and manufactured to DIN3113A

Combination Spanners:

20, 21, 22, 23, 24, 25, 26, 27, 28, 29, 30, 32 mm

Item ID: **6512MMA**

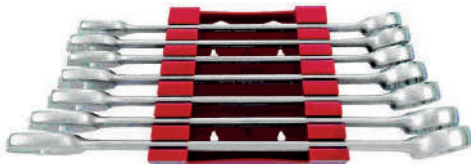

7 Pieces mm

**COMBINATION SPANNER SET 33-50 MM PLASTIC HOLDER 7 PIECES**

- Off set at 15° for easier use on flat surfaces
- TengTools hip grip design for contact with the flat side of the fastening
- Chrome vanadium satin finish
- Spanner holder can be used on it's own or it can be connected to set: 6512MMA
- Designed and manufactured to DIN3113A

Combination Spanners:

33, 34, 36, 38, 41, 46, 50 mm

Item ID: **6507JMMA**

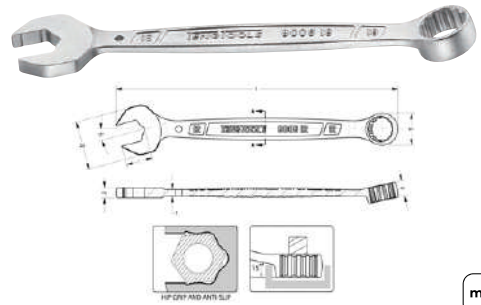

mm

**COMBINATION SPANNER ANTI SLIP METRIC**

- Anti slip metric combination spanner
- Off set at 15° for easier use on flat surfaces
- TengTools hip grip design on the ring and open end for contact with the flat side of the fastening
- TengTools anti slip design on the open end to give a much better grip with less risk of damaging the fastening

ITEM ID:	Size mm	L mm	H1 mm	H2 mm	D1 mm	D2 mm	T mm	Weight g
800608	8	120	6.6	4.5	12.8	18.9	3.2	24
800609	9	130	7	4.5	14.2	20.8	3.2	28
800610	10	140	7.7	5	15.6	22.5	3.6	36
800611	11	150	8.4	5.4	16.9	24.5	3.6	46
800612	12	160	8.5	5.5	18	27.2	3.6	58
800613	13	170	8.8	5.9	19.5	29.6	3.9	71
800614	14	180	9.6	6.2	21.5	31.1	4	81
800615	15	185	10.1	6.4	22.8	32.5	4.2	93
800616	16	195	10.5	6.5	24.2	35	4.5	110
800617	17	202	11	6.9	25.2	37	4.5	123
800618	18	208	11.5	7.1	26.8	39	4.8	135
800619	19	218	12.2	7.5	28.4	41.1	5	156



TengTools **Anti Slip** spanner design grips onto the surface of the nut or bolt, providing better traction and reducing the risk of the spanner slipping off the fastener. **Slipping or losing control of a spanner can cause injury or damage to the surrounding equipment.**

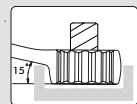
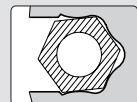



12 Pieces mm

**COMBINATION SPANNER ANTI SLIP WALL RACK**

- Off set at 15° for easier use on flat surfaces
- TengTools hip grip design on the ring and open end for contact with the flat side of the fastening
- TengTools anti slip design on the open end to give a much better grip
- Supplied with a wall rack for fixing to the wall or a workbench

Anti Slip Combination Spanners:

8, 9, 10, 11, 12, 13, 14, 15, 16, 17, 18, 19 mm



Item ID: **WR8012**



12 Pieces mm

**COMBINATION SPANNER SET ANTI SLIP TOOL ROLL 12 PIECES**

- Off set at 15° for easier use on flat surfaces
- TengTools hip grip design on the ring and open end for contact with the flat side of the fastening
- TengTools anti slip design on the open end to give a much better grip with less risk of damaging the fastening
- Supplied in a handy tool roll style wallet

Anti Slip Combination Spanners:

8, 9, 10, 11, 12, 13, 14, 15, 16, 17, 18, 19 mm



Item ID: **8512MM**



12 Pieces mm

**COMBINATION SPANNER SET ANTI SLIP PLASTIC HOLDER 12 PIECES**

- Off set at 15° for easier use on flat surfaces
- TengTools hip grip design on the ring and open end for contact with the flat side of the fastening
- TengTools anti slip design on the open end to give a much better grip with less risk of damaging the fastening
- Supplied in a holder that can be used for storage or for mounting on a wall

Anti Slip Combination Spanners:

8, 9, 10, 11, 12, 13, 14, 15, 16, 17, 18, 19 mm



Item ID: **8512A**



**TT SERIES**

Spanner Sets available

**MODULAR TOOL CONTROL SYSTEM**



**PAGE 68**

**FOAM SERIES**

Spanner Sets available

**MODULAR TOOL CONTROL SYSTEM**



**PAGE 132**

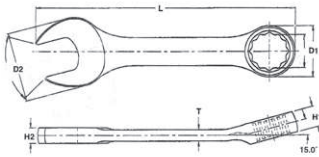

mm

**STUBBY COMBINATION SPANNER METRIC**

- Ideal for use in confined spaces
- Off set at 15° for easier use on flat surfaces
- TengTools hip grip design for contact with the flat side of the fastening
- Chrome vanadium satin finish
- Designed and manufactured to DIN3113A

ITEM ID:	Size mm	L mm	H1 mm	H2 mm	D1 mm	D2 mm	T mm	Weight g
6005M10	10	95	7	5.1	16.2	21.9	3.4	30
6005M11	11	100	7.8	5.9	17.9	23.8	4	42
6005M12	12	105	8.2	6.6	19.1	24.7	4.2	48
6005M13	13	110	8.8	6.7	19.3	27.1	5	55
6005M14	14	115	9.1	7.4	21.8	28.9	5.1	66
6005M15	15	120	9.2	7.5	22.6	31.1	5.1	71
6005M16	16	125	9.8	8.1	23.6	33	5.6	87
6005M17	17	130	10.3	8.3	25.9	36	5.6	105
6005M18	18	135	11	8.7	27.2	36.8	5.8	118
6005M19	19	140	11.2	9.4	28.7	38.1	6	130

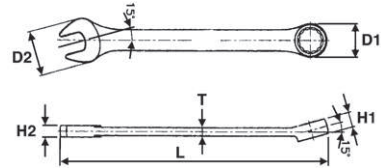

mm

**LONG COMBINATION SPANNER METRIC**

- Extra long metric combination spanner
- A ring and open ended spanner combined with the same size opening at each end
- Off set at 15° for easier use on flat surfaces
- TengTools hip grip design on the ring end for contact with the flat side of the fastening for reduced damage and use on rounded nuts and bolts
- Chrome vanadium satin finish
- Designed and manufactured to DIN3113A

ITEM ID:	Size mm	L mm	H1 mm	H2 mm	D1 mm	D2 mm	T mm	Weight g
605908	8	148	5.3	4.9	12.6	17.2	3.6	33
605909	9	158	6.2	5	13.7	19.4	3.8	40
605910	10	168	6.4	5.6	15.2	21.7	3.9	50
605911	11	188	7.3	5.6	16.7	23.1	4.2	62
605912	12	198	7.9	6.3	17.7	25.3	4.2	77
605913	13	208	8.6	6.7	19.8	26.6	4.5	87
605914	14	228	9	7.4	21.4	29.8	5	117
605915	15	238	9.9	7.6	22.5	32.4	5	142
605916	16	246	10.4	8.2	23.5	32.4	5.2	153
605917	17	266	10.5	8.2	25.4	36	5.8	174
605918	18	276	12.4	9	26.6	37.4	5.8	215
605919	19	285	12.6	9.1	28.3	39.8	6.1	220



**TT SERIES** Spanner Sets available

**MODULAR TOOL CONTROL SYSTEM**



**PAGE 68**

**FOAM SERIES** Spanner Sets available

**MODULAR TOOL CONTROL SYSTEM**



**PAGE 132**



12  
Pieces

mm

### LONG COMBINATION SPANNER WALL RACK

- Extra long for increased torque
- Off set at 15° for easier use on flat surfaces
- TengTools hip grip design for contact with the flat side of the fastening
- Supplied with a wall rack for fixing to the wall or a workbench
- Designed and manufactured to DIN3113A

Long Combination Spanners:

8, 9, 10, 11, 12, 13, 14, 15, 16, 17, 18, 19 mm

Item ID: **WRSP12LMP**



9  
Pieces

mm

### LONG COMBINATION SPANNER SET 8-19 MM TOOL ROLL 9 PIECES

- Extra long for increased torque
- Off set at 15° for easier use on flat surfaces
- TengTools hip grip design for contact with the flat side of the fastening
- Supplied in a handy tool roll style wallet
- Designed and manufactured to DIN3113A

Long Combination Spanners:

8, 10, 11, 12, 13, 14, 15, 17, 19 mm

Item ID: **6059LMP**



## Do's and Dont's of Spanners

### DO'S

- **Use the right size spanner** for the job: Make sure you have the correct size spanner for the nut or bolt you are working on.
- **Keep the spanner clean and dry:** Wipe down the spanner after use to prevent rust and corrosion.
- **Apply pressure correctly:** Apply pressure to the spanner in the direction that tightens the nut or bolt.
- **Use the right technique:** Use a firm grip on the spanner and turn it with a smooth motion. Avoid jerking or twisting the spanner, as this can cause damage to both the tool and the fastener.
- **Inspect the spanner regularly:** Check the spanner for any signs of wear or damage. Replace any damaged tools immediately.

### DONT'S

- **Use a damaged spanner:** Do not use a spanner that is damaged or worn, as it may slip or break during use.
- **Use a spanner as a hammer:** Do not use a spanner as a hammer or pry bar, as this can damage both the spanner and the object you are working on.
- **Over-tighten nuts and bolts:** Do not over-tighten nuts and bolts with a spanner, as this can cause damage to the fastener and the tool.
- **Use a spanner in wet or oily conditions:** Do not use a spanner in wet or oily conditions, as this can cause the tool to slip and cause injury.



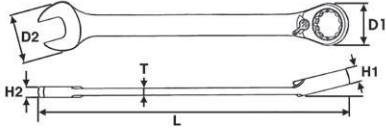

mm

**RATCHETING COMBINATION SPANNER METRIC R**

- A ratcheting ring and open ended spanner combined with the same size at each end
- Off set at 13° for easier use on flat surfaces
- TengTools hip grip design on the ring end for contact with the flat side of the fastening
- 72 teeth ratchet spanners giving a 5° increment between clicks
- Reversible ratchet mechanism with a flip reverse lever
- Ideal for rapid tightening and loosening of fastenings
- Chrome vanadium satin finish
- Designed and manufactured to DIN ISO 1711-1 and DIN 3113A

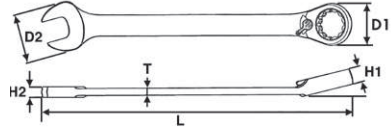

AF

**RATCHETING COMBINATION SPANNER AF R**

- A ratcheting ring and open ended spanner combined with the same size at each end
- Off set at 13° for easier use on flat surfaces
- TengTools hip grip design on the ring end for contact with the flat side of the fastening
- 72 teeth ratchet spanners giving a 5° increment between clicks
- Reversible ratchet mechanism with a flip reverse lever
- Ideal for rapid tightening and loosening of fastenings
- Chrome vanadium satin finish
- Manufactured to DIN ISO 1711-1 and ASME B107.100



ITEM ID:	Size mm	L mm	H1 mm	H2 mm	D1 mm	D2 mm	T mm	Weight g
600508R	8	140	6.5	4	17	17	2.8	30
600509R	9	150	6.9	4.4	18.5	19	2.7	30
600510R	10	159	7.3	4.8	20	21	3.3	50
600511R	11	165	7.7	5.2	22	23	3.6	70
600512R	12	172	8.2	5.5	23	25	3.9	80
600513R	13	178	8.5	5.8	25	27	4	100
600514R	14	191	9	6.2	27	29	4.3	120
600515R	15	200	9.4	6.5	28	31	4.5	140
600516R	16	208	9.9	6.8	30	33	4.7	170
600517R	17	226	10.3	7.2	32	36	5	200
600518R	18	237	10.7	7.7	33	38	5.2	210
600519R	19	248	11.2	8.2	34	40	5.5	220
600522R	22	290	13	9	38.4	45	6	360
600524R	24	323	14.5	9.8	43.6	52	6.5	510
600527R	27	359	15.5	10.5	52.5	56	7.7	640
600530R	30	403	17	11.4	58.5	59	8.2	880
600532R	32	425	17.5	12.5	62.5	63	8.7	1080

ITEM ID:	Size AF	L mm	H1 mm	H2 mm	D1 mm	D2 mm	T mm	Weight g
600110R	5/16"	140	6.5	4.6	16.6	16.7	3	30
600112R	3/8"	159	7.3	5.3	20	20.8	3.4	50
600114R	7/16"	165	7.7	5.6	21.8	23	3.7	70
600116R	1/2"	178	8.6	6.4	24.7	27.1	4.1	100
600118R	9/16"	191	9	6.8	27	29.2	4.4	120
600120R	5/8"	208	9.9	7.2	30	33.4	4.7	170
600122R	11/16"	226	10.3	7.7	31.8	35.5	5.1	200
600124R	3/4"	248	11.2	8.8	33.8	39.7	5.6	320
600126R	13/16"	290	13	9	40	46	6	360
600128R	7/8"	290	13	9	40	46	6	510

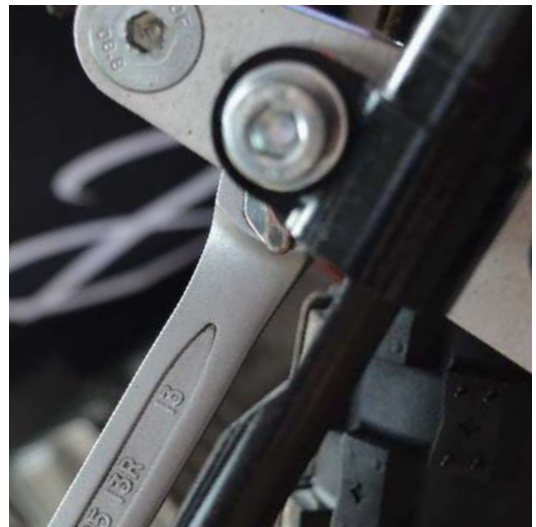



8 Pieces mm

**RATCHETING COMBINATION SPANNER SET R TOOL ROLL 8 PIECES**

- 72 teeth ratchet spanners giving a 5° increment between clicks
- Reversible ratchet mechanism with hip grip & flip reverse lever
- Chrome vanadium satin finish
- Supplied in a handy tool roll style wallet
- Designed and manufactured to DIN ISO 1711-1 and DIN 3113A

Ratchet Spanners with flip reverse switch:

8, 10, 11, 12, 13, 14, 17, 19 mm

Item ID: **6508RMM**



10 Pieces mm

**RATCHETING COMBINATION SPANNER SET R TOOL ROLL 10 PIECES**

- 72 teeth ratchet spanners giving a 5° increment between clicks
- Reversible ratchet mechanism with hip grip & flip reverse lever
- Chrome vanadium satin finish
- Supplied in a handy tool roll style wallet
- Designed and manufactured to DIN ISO 1711-1 and DIN 3113A

Ratchet Spanners with flip reverse switch:

10, 11, 12, 13, 14, 15, 16, 17, 18, 19 mm

Item ID: **6510RMM**

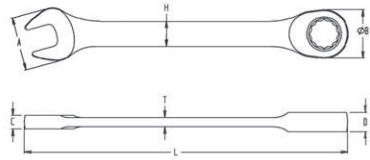

mm

**RATCHETING COMBINATION SPANNER METRIC RS**

- A ratcheting ring and open ended spanner combined with the same size at each end
- Simply turn over to reverse the direction of use when ratcheting
- TengTools hip grip design on the ring end for contact with the flat side of the fastening
- 72 teeth ratchet spanners giving a 5° increment between clicks
- Ideal for rapid tightening and loosening of fastenings
- Chrome vanadium satin finish
- Designed and manufactured to DIN ISO 1711-1 and DIN 3113A

ITEM ID:	Size mm	L mm	A mm	B mm	C mm	D mm	H mm	T mm	Weight g
600508RS	8	111	19.6	17	4	6.8	8	2.8	30
600509RS	9	123	20.8	19	4.4	7.2	9	2.9	41
600510RS	10	131	22	20	4.8	7.6	9.5	3.3	48
600511RS	11	147	24.2	21	5.2	8	10	3.6	62
600512RS	12	155	25.7	23	5.5	8.5	11	3.9	78
600513RS	13	164	27.2	25	5.8	8.9	12	4	88
600514RS	14	182	30.8	27	6.2	9.3	13	4.3	112
600515RS	15	192	32.4	28	6.5	9.7	13.6	4.5	123
600516RS	16	202	34	30	6.8	10.2	14.4	4.7	144
600517RS	17	223	37.7	32	7.2	10.6	15.3	5	192
600518RS	18	234	39.3	33	7.7	11	16.2	5.2	207
600519RS	19	246	40.8	34	8.2	11.5	17	5.5	233
600520RS	20	285	46	42	10	13	18.8	6.4	385
600521RS	21	285	46	42	10	13	18.8	6.4	385
600522RS	22	285	46	42	10	13	18.8	6.4	387
600524RS	24	325	51.5	47.5	11	14.5	20.6	7	511







12 Pieces mm

### RATCHETING COMBI SPANNER RS WALL RACK

- 72 teeth ratchet spanners giving a 5° increment between clicks
- Simply turn over to reverse the direction of use when ratcheting
- Chrome vanadium satin finish
- Supplied with a wall rack for fixing to the wall or a workbench
- Designed and manufactured to DIN ISO 1711-1 and DIN 3113A

Ratchet Spanners:

8, 9, 10, 11, 12, 13, 14, 15, 16, 17, 18, 19 mm

Item ID: **WRSP12RS**



8 Pieces mm

### RATCHETING COMBINATION SPANNER SET RS TOOL ROLL 8 PIECES

- 72 teeth ratchet spanners giving a 5° increment between clicks
- Hip grip on the ring end, turn spanner over to change direction
- Chrome vanadium satin finish
- Supplied in a handy tool roll style wallet
- Designed and manufactured to DIN ISO 1711-1 and DIN 3113A

Ratchet Spanners:

8, 10, 11, 12, 13, 14, 17, 19 mm

Item ID: **6508RSMM**



12 Pieces mm

### RATCHETING COMBINATION SPANNER SET RS TOOL ROLL 12 PIECES

- 72 teeth ratchet spanners giving a 5° increment between clicks
- Hip grip on the ring end, turn spanner over to change direction
- Chrome vanadium satin finish
- Supplied in a handy tool roll style wallet
- Designed and manufactured to DIN ISO 1711-1 and DIN 3113A

Ratchet Spanners:

8, 9, 10, 11, 12, 13, 14, 15, 16, 17, 18, 19 mm

Item ID: **6512RSMM**

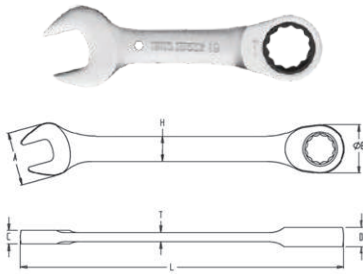

**STUBBY RATCHETING COMBINATION SPANNERS**

- Ideal for use in confined spaces
- A ratcheting ring and open ended spanner combined with the same size at each end
- Simply turn over to reverse the direction of use when ratcheting
- TengTools hip grip design on the ring end for contact with the flat side of the fastening
- 72 teeth ratchet spanners giving a 5° increment between clicks
- Ideal for rapid tightening and loosening of fastenings
- Chrome vanadium satin finish

ITEM ID:	Size mm	L mm	A mm	B mm	C mm	D mm	H mm	T mm	Weight g
6005M10RS	10	97	22	20	4.8	7.6	9.5	3.3	36
6005M11RS	11	102	24.2	21	5.2	8	10	3.6	47
6005M12RS	12	106	25.7	23	5.5	8.5	11	3.9	49
6005M13RS	13	110	27.2	25	5.8	8.9	12	4	61
6005M14RS	14	115	30.8	27	6.2	9.3	13	4.3	75
6005M15RS	15	119	32.4	28	6.5	9.7	13.6	4.5	95
6005M16RS	16	123	34	30	6.8	10.2	14.4	4.7	105
6005M17RS	17	127	37.7	32	7.2	10.6	15.3	5	120
6005M18RS	18	132	39.3	33	7.7	11	16.2	5.2	136
6005M19RS	19	139	40.8	34	8.2	11.5	17	5.5	150

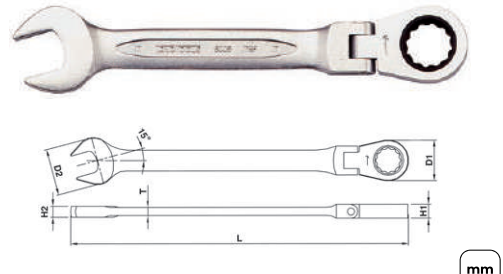

**FLEX-HEAD RATCHETING COMBINATION SPANNER METRIC RF**

- A ratcheting ring and open ended spanner with the same size at each end
- TengTools hip grip design on the ring end for contact with the flat side of the fastening
- 72 teeth ratchet spanners giving a 5° increment between clicks
- Reversible ratchet mechanism
- Ideal for rapid tightening and loosening of fastenings
- Chrome vanadium satin finish
- Designed and manufactured to DIN ISO 1711-1 and DIN 3113A

ITEM ID:	Size mm	L mm	H1 mm	H2 mm	D1 mm	D2 mm	T mm	Weight g
600507RF	7	127	6.8	4	17	17.6	2.8	50
600508RF	8	127	6.8	4	17	17.6	2.8	50
600509RF	9	131	7.2	4.4	19	19.8	2.9	50
600510RF	10	136	7.6	4.8	20	22	3.3	60
600511RF	11	141	8	5.2	21	24.1	3.6	60
600512RF	12	147	8.5	5.5	23	25.9	3.9	80
600513RF	13	154	9	5.8	25	27.3	4	100
600514RF	14	160	9.3	6.2	27	30.6	4.3	120
600515RF	15	169	9.7	6.5	28	32.2	4.3	120
600516RF	16	179	10.2	6.8	30	33.7	4.7	160
600517RF	17	190	10.6	7.2	32	36.6	5	190
600518RF	18	203	11	7.7	33	38.4	5.2	190
600519RF	19	215	11.5	8.2	34	40.2	5.5	200



**SPANNER RING**

- Spanner ring with carabiner style snap hook
- Ideal for storing combination and double ring spanners
- Alternatively use as a belt hook for spanners with a ring end

Item ID: **600**

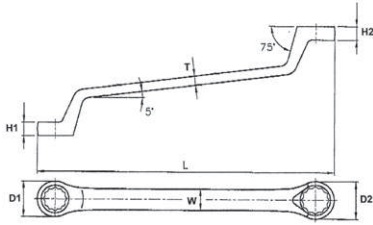

mm

**DOUBLE RING SPANNER METRIC**

- Different size at each end to give 2 sizes with one wrench
- Double curved heads offset at 75° for easier use on flat surfaces
- Chrome vanadium satin finish
- TengTools hip grip design for contact with the flat side of the fastening
- Designed and manufactured to DIN 838

ITEM ID:	Size mm	L mm	H1 mm	H2 mm	D1 mm	D2 mm	T mm	Weight g
630607	6x7	168	5.6	6.3	10.7	12.2	4.1	45
630809	8x9	183	6.6	7	13.6	15.1	4.5	60
631011	10x11	198	7.4	7.7	16.6	18	4.9	100
631213	12x13	217	8.1	8.4	19.5	20.9	5.4	105
631415	14x15	239	8.8	9.1	22.4	23.7	5.7	145
631617	16x17	260	9.5	9.8	25.3	26.7	6.2	195
631819	18x19	292	10.1	10.4	28.2	29.7	6.6	250
632022	20x22	318	10.9	11.4	31.1	34	7.1	320
632123	21x23	326.5	11.2	11.6	32.6	35.5	7.6	340
632427	24x27	329	12.4	13.4	36.9	41	8.1	475
633032	30x32	362	14.4	15.2	45.5	48.5	9	522

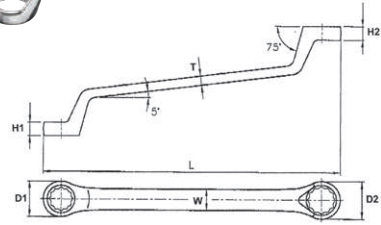

AF

**DOUBLE RING SPANNER AF**

- Different size at each end to give 2 sizes with one wrench
- Double curved heads offset at 75° for easier use on flat surfaces
- Chrome vanadium satin finish
- TengTools hip grip design for contact with the flat side of the fastening

ITEM ID:	Size AF	L mm	H1 mm	H2 mm	D1 mm	D2 mm	T mm	Weight g
673032	1/4 x 5/16	168	5.6	6.3	10.7	12.2	4.1	45
673436	3/8 x 7/16	198	7.4	7.7	16.6	18	4.9	93
673840	1/2 x 7/16	217	8.1	7.7	19.5	20.9	5.4	135
674244	13/16 x 7/8	318	10.9	11.4	31.1	34	7.1	325
674648	15/16 x 1-1/16	347	12.4	13.4	36.9	40.5	8.1	475
675052	1 x 1-1/8	355	12.7	13.7	38.4	42.8	8.5	570
675456	1-1/8 x 1-1/4	362	14.4	15.2	45.5	48.5	9	650



**TT SERIES** Spanner Sets available

**MODULAR TOOL CONTROL SYSTEM**



**PAGE 68**

**FOAM SERIES** Spanner Sets available

**MODULAR TOOL CONTROL SYSTEM**



**PAGE 132**

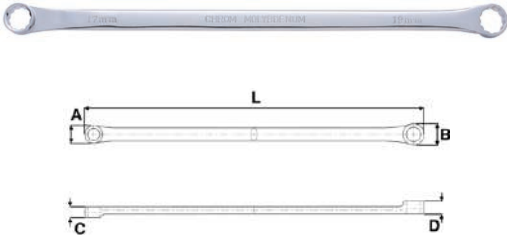

mm

**LONG DOUBLE RING SPANNER METRIC**

- Metric long reach double ring spanner
- Flat design for use in confined spaces
- Different size at each end to give 2 sizes with one wrench
- Chrome vanadium satin finish
- TengTools hip grip design for contact with the flat side of the fastening
- Designed and manufactured to DIN837

ITEM ID:	Size mm	L mm	A mm	B mm	C mm	D mm	Weight g
630810FL	8x10	265	12.5	15	7.5	8.4	72
631113FL	11x13	328	17.8	20.3	10.4	11.3	155
631214FL	12x14	328	17.8	20.3	10.4	11.3	157
631618FL	16x18	408	23.4	26.3	12.8	14.4	284
631719FL	17x19	407	23.7	26.6	13	14.8	284
632224FL	22x24	430	31.3	34	15.4	17.7	482



mm

**DOUBLE RING SPANNER RIGGER JIGGER 10 X 13MM**

- The original TengTools Rigger Jigger
- 10 x 13mm double ring spanner
- Compact, angled heads and 12 point opening at each end
- The two most commonly used sizes in one handy tool

Item ID: **601013**



5 Pieces mm

**LONG DOUBLE RING SPANNER WALL RACK**

- Different size at each end to give 10 sizes in total
- Extra long, flat design for extra torque and easier access
- Chrome vanadium satin finish
- TengTools hip grip design for contact with the flat side of the fastening
- Supplied with a wall rack for fixing to the wall or a workbench

Extra long Double Ring Spanners:

8x10, 11x13, 12x14, 17x19, 22x24 mm

Item ID: **WRFLS05**



8 Pieces mm

**DOUBLE RING SPANNER SET 8 PIECES**

- Different size at each end to give 16 sizes in total
- Double curved heads offset at 75° for easier use on flat surfaces
- Chrome vanadium satin finish
- TengTools hip grip design for contact with the flat side of the fastening
- Designed and manufactured to DIN 838

Double Ring Spanners:

6x7, 8x9, 10x11, 12x13, 14x15, 16x17, 18x19, 20x22 mm

Item ID: **6308**





11 Pieces mm

**DOUBLE RING SPANNER SET 11 PIECES**

- Different size at each end to give 22 sizes in total
- Double curved heads offset at 75° for easier use on flat surfaces
- Chrome vanadium satin finish
- TengTools hip grip design for contact with the flat side of the fastening
- Designed and manufactured to DIN 838

Double Ring Spanners:

6x7, 8x9, 10x11, 12x13, 14x15, 16x17, 18x19, 20x22, 21x23, 24x27, 30x32 mm

Item ID: **6311**



7 Pieces AF

**DOUBLE RING SPANNER SET AF TOOL ROLL 7 PIECES**

- Different size at each end to give 22 sizes in total
- Double curved heads offset at 75° for easier use on flat surfaces
- Chrome vanadium satin finish
- TengTools hip grip design for contact with the flat side of the fastening
- Designed and manufactured to DIN838

Double Ring Spanners:

1/4"x5/16", 3/8"x7/16", 7/16"x1/2", 13/16"x7/8", 15/16"x1-1/16", 1"x1-1/8", 1-1/8"x1-1/4"

Item ID: **6707AF**



8 Pieces mm

**DOUBLE RING SPANNER SET TOOL ROLL 8 PIECES**

- Different size at each end to give 16 sizes in total
- Double curved heads offset at 75° for easier use on flat surfaces
- Chrome vanadium satin finish
- TengTools hip grip design for contact with the flat side of the fastening
- Supplied in a handy tool roll style wallet
- Designed and manufactured to DIN 838

Double Ring Spanners:

6x7, 8x9, 10x11, 12x13, 14x15, 16x17, 18x19, 20x22 mm

Item ID: **6308MM**



mm

**DOUBLE OPEN ENDED SPANNER METRIC**

- Different size at each end to give 2 sizes with one wrench
- Open at each end off set at 15° for easier use
- Chrome vanadium satin finish
- Designed and manufactured to DIN3110

ITEM ID:	Size mm	L mm	H mm	D1 mm	D2 mm	T mm	Weight g
620607	6x7	123	3.7	18	15.5	3.7	25
620809	8x9	140	4	22.7	20.4	4	35
621011	10x11	156	5	27.1	24.9	5	50
621213	12x13	172	5.5	31.2	29.2	5.5	75
621415	14x15	188.5	5.9	35.3	33.3	5.9	105
621617	16x17	204	6.3	38.9	37.1	6.3	155
621819	18x19	221	6.7	42.8	40.9	6.7	190
622022	20x22	237	7.1	48.8	44.8	7.1	220
622123	21x23	247	7.7	50.8	46.8	7.7	245
622427	24x27	263	8.1	59.1	52.8	8.1	305
623032	30x32	298	9	69.8	65.4	9	465

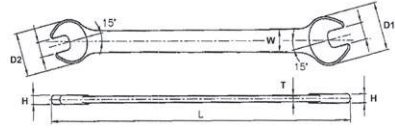

AF

**DOUBLE OPEN ENDED SPANNER AF**

- Different size at each end to give 2 sizes with one wrench
- Open at each end off set at 15° for easier use
- Chrome vanadium satin finish
- Designed and manufactured to ASME B107.100

ITEM ID:	Size AF	L mm	H mm	D1 mm	D2 mm	T mm	Weight g
663032	1/4 x 5/16	123	2.9	15.5	18	2.9	25
663436	3/8 x 7/16	156	3.4	24.9	27.1	3.4	61
663840	1/2 x 9/16	180	4	31.3	33.3	4	85
664244	5/8 x 3/4	221	4.6	37.1	42.8	4.6	160
664648	13/16 x 7/8	237	4.9	44.8	48.8	4.9	220
665052	15/16 x 1	255	5.3	50.8	56.8	5.3	298
665456	1-1/8 x 1-1/4	298	6	65.4	69.8	6	470



**TT SERIES** Spanner Sets available

**MODULAR TOOL CONTROL SYSTEM**



**PAGE 68**

**FOAM SERIES** Spanner Sets available

**MODULAR TOOL CONTROL SYSTEM**



**PAGE 132**



8 Pieces mm

**DOUBLE OPEN ENDED SPANNER SET 8 PIECES**

- Different size at each end to give 16 sizes in total
- Open at each end off set at 15° for easier use
- Chrome vanadium satin finish
- Designed and manufactured to DIN3110 and DIN3113A

Double Open Ended Spanners:

6x7, 8x9, 10x11, 12x13, 14x15, 16x17, 18x19, 20x22 mm

Item ID: **6208**



11 Pieces mm

**DOUBLE OPEN ENDED SPANNER SET 11 PIECES**

- Different size at each end to give 22 sizes in total
- Open at each end off set at 15° for easier use
- Chrome vanadium satin finish
- Designed and manufactured to DIN3110

Double Open Ended Spanners:

6x7, 8x9, 10x11, 12x13, 14x15, 16x17, 18x19, 20x22, 21x23, 24x27, 30x32 mm

Item ID: **6211**



11 Pieces mm

**DOUBLE OPEN ENDED SPANNER SET TOOL ROLL 11 PIECES**

- Different size at each end to give 22 sizes in total
- Open at each end off set at 15° for easier use
- Chrome vanadium satin finish
- Supplied in a handy tool roll style wallet
- Designed and manufactured to DIN3110 and DIN3113A

Double Open Ended Spanners:

6x7, 8x9, 10x11, 12x13, 14x15, 16x17, 18x19, 20x22, 21x23, 24x27, 30x32 mm

Item ID: **6211MM**



7 Pieces AF

**DOUBLE OPEN ENDED SPANNER SET AF TOOL ROLL 7 PIECES**

- Different size at each end to give 14 sizes in total
- Chrome vanadium satin finish
- TengTools hip grip design for contact with the flat side of the fastening
- Designed and manufactured to ASME B107.100

Double Open Ended Spanners:

1/4" x 5/16", 3/8" x 7/16", 1/2" x 9/16", 5/8" x 3/4", 13/16" x 7/8", 15/16" x 1", 1-1/8" x 1-1/4"

Item ID: **6607AF**

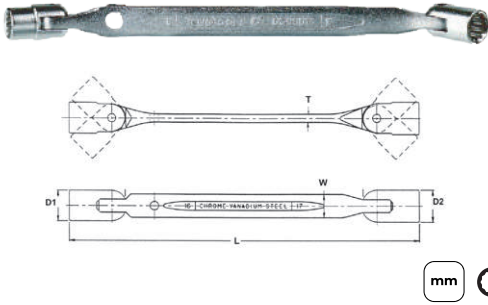

**DOUBLE FLEX WRENCH METRIC**

- Swivel end wrench for fast pre-tightening and loosening
- 12 point socket at each end with 2 different sizes in one wrench
- Angle at 90° for added torque when applying the final tightening
- Extra torque for loosening stubborn fastenings
- Chrome vanadium satin finish
- Designed and manufactured to DIN standards

ITEM ID:	Size mm	L mm	D1 mm	D2 mm	W mm	T mm	Weight g
650809	8x9	192	12.2	13.5	10	4.6	95
651011	10x11	200	15.5	16.9	10	4.6	105
651013	10x13	213	14.5	18.2	12.5	5	140
651213	12x13	218	18.2	19.2	12.5	5	150
651415	14x15	243	20.5	21.7	14	5.8	215
651617	16x17	275	23	24.2	15	6.5	300
651819	18x19	284	25.5	26.7	16	7.5	382



**DOUBLE FLEX WRENCH AF**

ITEM ID:	Size AF	L mm	D1 mm	D2 mm	W mm	T mm	Weight g
611214	3/8"x7/16"	200	15.5	16.9	10	4.6	105
611618	1/2"x9/16"	218	18.2	19.2	12.5	5	150
612022	5/8"x11/16"	275	23	24.2	14	6.5	300



**DOUBLE FLEX WRENCH SET WALL RACK**

- Swivel end wrenches for fast pre-tightening and loosening
- Angle at 90° for added torque when applying the final tightening
- Extra torque for loosening stubborn fastenings
- Chrome vanadium satin finish
- Supplied with a wall rack for fixing to the wall or a workbench

Double Flex Wrenches
8x9, 10x11, 12x13, 14x15, 16x17, 18x19 mm

Item ID: **WRDF06**

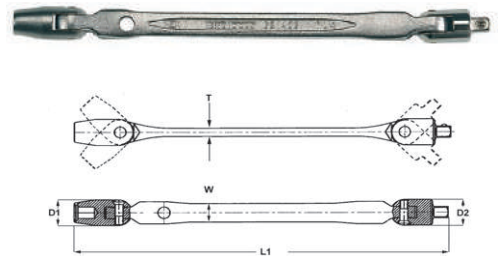

**BI-FLEX WRENCH**

- Swivel end wrench for fast pre-tightening and loosening
- 1/4" bit socket at one end to suit screwdriver bits
- 1/4" male drive on the other end to suit 1/4" drive sockets
- Angle at 90° for added torque
- Chrome vanadium satin finish
- Designed and manufactured to DIN standard

ITEM ID:	Sizes	L mm	D1 mm	D2 mm	W mm	T mm	Weight g
691406	1/4" Hex x 1/4" M	196	14.5	14.5	10	4.6	102





mm

**FLARE NUT WRENCH METRIC**

- Opening designed to allow use over pipes when tightening flare nuts
- Ideal for use on hydraulic systems on vehicles
- Also suitable for use on water pipe connections
- Different size at each end to give 2 sizes with one wrench
- Open at each end off set at 15° for easier use
- Chrome vanadium satin finish
- Designed and manufactured to DIN 3118

ITEM ID:	Sizes mm	L mm	H mm	D1 mm	D2 mm	C1 mm	C2 mm	T mm	Weight g
641011	10x11	152.4	7.9	21.4	23	7	8.2	4.3	60
641213	12x13	178.6	10	25	27.4	9	10.3	5.7	113
641314	13x14	178.6	13.1	25	27.4	14.3	15.1	5.7	113
641617	16x17	196	15.1	29.9	31.9	15.4	17	6.4	113
641922	19x22	207.7	17	34.2	38.2	18.9	20	7.4	113



**FLARE NUT WRENCH AF**

ITEM ID:	Sizes mm	L mm	H mm	D1 mm	D2 mm	C1 mm	C2 mm	T mm	Weight g
661416	7/16"x1/2"	158.8	11.9	23	24.3	8.2	9	5.5	113

AF

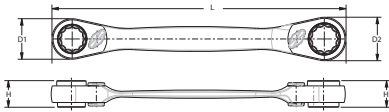

mm

**RATCHETING MULTI DRIVE RING SPANNER**

- Two size openings at each end
- 4 different spanner sizes in one handy tool
- TengTools hip grip design on the ring end for contact with the flat side of the fastening
- 72 teeth ratchet spanners giving a 5° increment between clicks
- Reversible ratchet mechanism with a flip reverse lever at each end
- Ideal for rapid tightening and loosening of fastenings
- Chrome vanadium satin finish

ITEM ID:	Sizes mm	L mm	D1 mm	D2 mm	Weight g
60050811RX	8, 9, 10, 11	150	19.2	22	13.5
60051215RX	12, 13, 14, 15	190	25.5	28	18.4
60051619RX	16, 17, 18, 19	320	31.7	34	20.8



3 Pieces mm

**RATCHETING MULTI DRIVE RING SPANNER SET 3 PIECES**

- Two size openings at each end
- 4 different spanner sizes in one handy tool
- TengTools hip grip design on the ring end for contact with the flat side of the fastening
- 72 teeth ratchet spanners giving a 5° increment between clicks
- Reversible ratchet mechanism with a flip reverse lever at each end
- Ideal for rapid tightening and loosening of fastenings
- Chrome vanadium satin finish
- Supplied in a wallet bag

Multidrive Ring Spanners:

8x9x10x11, 12x13x14x15, 16x17x18x19 mm

Item ID: **6503RX**

**MULTI DRIVE RING SPANNER SERVICE KITS**

- Replacement ratchet heads for the Ratcheting Multi Drive Ring Spanners

ITEM ID:	Service Kit For:	Size:
60050809RXRK	60050811RX	8x9
60051011RXRK	60050811RX	10x11
60051213RXRK	60051215RX	12x13
60051415RXRK	60051215RX	14x15
60051617RXRK	60051619RX	16x17
60051819RXRK	60051819RX	18x19

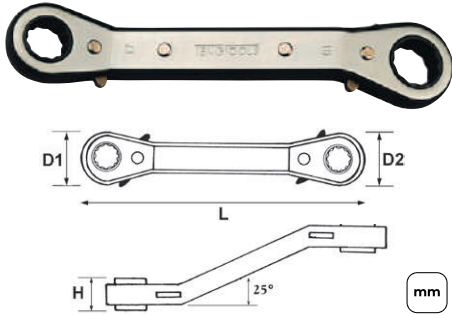

**RATCHETING OFFSET RING SPANNER METRIC**

- Fibre reinforced reversible ratchet wrench
- 18 teeth for extra strength and use in outdoor sites
- Double ended with 25° offset heads
- 6mm has a 6 point ring end while other sizes have 12 point ring ends
- Chrome vanadium satin finish with FRP body

ITEM ID:	Sizes mm	L mm	H mm	D1 mm	D2 mm	Weight g
680608	6x8	112	8	20	20	63
680709	7x9	133	8.4	21	23	81
681013	10x13	163	10.2	26	30	149
681214	12x14	172	10.2	30	32	169
681719	17x19	203	11	37	40	254
682122	21x22	235	11.4	41	45	290

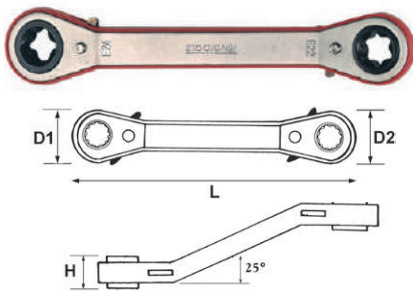

**RATCHETING OFFSET TX-E RING SPANNER**

- Fibre reinforced reversible ratchet wrench
- 18 teeth for extra strength and use in outdoor sites
- Double ended with 25° offset heads
- For use with external TX fastenings
- Chrome vanadium satin finish with FRP body

ITEM ID:	Sizes mm	L mm	H mm	D1 mm	D2 mm	Weight g
680810E	E8xE10	133	8.2	21	23	84
681112E	E11xE12	140	8.2	23	26	95
681416E	E14xE16	172	10.2	30	32	174
681820E	E18xE20	203	11.5	37	40	280
682224E	E22xE24	235	11.5	41	44	330

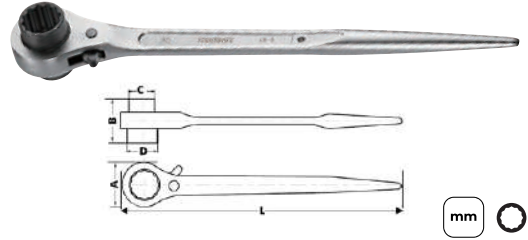

**RATCHETING CONSTRUCTION WRENCH**

- For use in construction
- Ideal for scaffolding, pallet racking, shelving systems and metal panel erection
- 2 sizes in one with 12 point double ended sockets
- 32 teeth for extra strength and use in outdoor sites
- Flip reverse for quickly changing between tightening and loosening
- Tapered podger style handle for aligning holes prior to fixing
- Hole in the handle for use with a fall protection wire

ITEM ID:	Sizes mm	L mm	A mm	B mm	C mm	D mm	Weight g
PGW1719	17 x 19	315	42	50	26	26.3	450
PGW1922	19 x 22	315	42	50	26	29.5	450
PGW1924	19 X 24	315	42	50	26	32	469
PGW2124	21 x 24	315	42	50	28	32	462
PGW2430	24 X 30	450	63	63	32	40	1332
PGW2730	27 x 30	366	65	63	36.6	40	1350



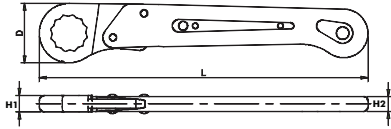

mm

**QUICK WRENCH**

- Special design for loosening and tightening pipe and hose couplings
- Ideal for use in confined spaces
- Ring end opens up easily to access the nut on the coupling

ITEM ID:	Size mm	L mm	D mm	H1 mm	H2 mm	Weight g
600813	13	141	27.5	7.2	8	92
600814	14	191	35.7	10	9	165
600816	16	191	35.7	10	9	165
600817	17	191	35.7	10	9	180
600819	19	191	35.7	10	9	225
600822	22	233	40.7	13	12	294
600824	24	235	43.2	13	12	300
600827	27	325	54.2	14.1	14.4	625
600830	30	325	56.4	15.9	14.4	610
600832	32	325	58.5	15.9	14.4	625



**HOOK WRENCH**

- Suitable for use with locking nuts and bearing carriers
- Chrome vanadium satin finish
- Designed to fit locking nuts according to DIN 1804
- Designed and manufactured to DIN 1810

ITEM ID:	Capacity mm	Capacity AF	Length mm	Length AF	Weight g
HP101	19 to 50	3/4" to 2"	145	5-3/4"	122
HP102	32 to 75	1-1/4" to 3"	178	7"	234
HP103	50 to 120	2" to 4-3/4"	247	9-3/4"	447



**PIN WRENCH**

- Suitable for use with locking nuts and bearing carriers
- Chrome vanadium satin finish
- Designed to fit locking nuts according to DIN 1816
- Designed and manufactured to DIN 1810

ITEM ID:	Pin Size mm	Capacity mm	Capacity AF	Length mm	Length AF	Weight g
HP2014	4	19 to 50	3/4" to 2"	145	5-3/4"	122
HP2015	5	19 to 50	3/4" to 2"	145	5-3/4"	122
HP2025	5	32 to 75	1-1/4" to 3"	178	7"	227
HP2026	6	32 to 75	1-1/4" to 3"	178	7"	227
HP2036	6	50 to 120	2" to 4-3/4"	247	9-3/4"	451
HP2038	8	50 to 120	2" to 4-3/4"	247	9-3/4"	451

**SPARE PARTS FOR HOOK AND PIN WRENCHES**

- Replacement pins for TengTools pin wrenches

ITEM ID:	Suitable For:
HP2014-P	HP2014 pin wrench
HP2015-P	HP2015 & HP2025 pin wrenches
HP2026-P	HP2026 pin wrench
HP2036-P	HP2036 pin wrench
HP2038-P	HP2038 pin wrench

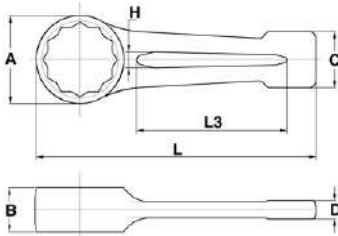

mm

**RING END SLOGGING WRENCH METRIC**

- Designed for extra heavy duty work
- For use with a hammer or sledge hammer
- Manufactured in impact resistant Chrome molybdenum
- Designed and manufactured to DIN 7444

ITEM ID:	Size mm	L mm	A mm	B mm	C mm	D mm	L3 mm	H mm	Weight g
903024	24	162	42.8	14.7	24.6	7.9	93.9	9.4	248
903027	27	180	45.2	15.4	25	8.6	107.3	9.4	260
903030	30	190	50.6	16.2	29.4	9.3	107.3	11.5	376
903032	32	190	53.7	16.4	31.7	10	107.3	12.3	480
903036	36	205	58.3	17.9	35.6	10.5	107.3	13.3	520
903038	38	229	63.7	19.9	36.9	12	130.3	13.3	660
903041	41	230	63.9	19.9	37.4	12.3	130.3	13.3	780
903046	46	240	73.5	21.8	43.9	12.5	130.9	14.5	1150
903050	50	255	78.5	23.2	46.3	13	134.5	17	1070
903055	55	266	85.1	25	49.4	15.5	141.2	19.3	1350
903060	60	280	91.7	26.5	52.2	16.5	150	22.7	1650
903065	65	298	100	27.5	54	16.5	150	23.2	1890
903070	70	330	109.5	32.8	62	20	165	24.6	2850
903075	75	330	110	32.8	62.2	20	154	24.6	2700
903080	80	355	129.4	37	82.3	23.8	170	40	3400
903085	85	355	129.5	37.3	82	23.4	170	40	4100
903090	90	395	143.5	40	72.7	24.2	170	47.5	5200
903095	95	390	144	37.1	72.8	20.8	165	47.5	5100
903100	100	420	155	41.6	80	23.6	175	50	6700

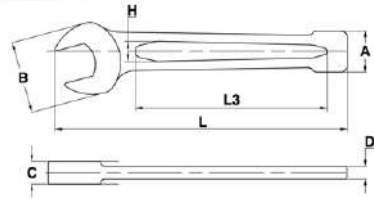

mm

**OPEN END SLOGGING WRENCH METRIC**

- Designed for extra heavy duty work
- For use with a hammer or sledge hammer
- Manufactured in impact resistant Chrome molybdenum
- Designed and manufactured to DIN 133

ITEM ID:	Size mm	L mm	A mm	B mm	C mm	D mm	L3 mm	H mm	Weight g
902024	24	178	52.3	14.5	23.4	7.8	107.5	10.2	250
902027	27	180	55	15.5	25.2	8.6	107.5	10.2	350
902030	30	190	60.4	16.2	30	9.5	107.5	15.6	500
902032	32	190	60.5	16.7	30.5	9.8	108	14.8	480
902036	36	214	71.3	17	35	9.8	118	14.9	700
902038	38	215	72	17.3	37	9.8	118	16.2	750
902041	41	233	82.4	19.2	39.3	12	127.6	18.3	900
902046	46	252	93.2	20.4	44.2	12.8	135.6	18.8	1300
902050	50	275	104	21.3	48	13.2	140.8	19.6	1500
902055	55	295	114.4	23.8	54.2	15.3	158.6	24.2	1950
902060	60	315	125.1	26.6	58.8	17.3	166.2	24.8	2500
902065	65	340	138	28.8	55	17.6	175	25.1	3300
902070	70	370	152.7	30.6	69	19	190	32	4300
902075	75	370	152.7	31	69	19	190	33.4	4700
902080	80	397	175	33.2	71.5	19	180	46.6	5500
902085	85	397	175	33.2	71.5	19	180	46.6	5200
902090	90	444	191	34.7	80	19.6	190	51.7	7000
902095	95	444	191.3	36.3	80	21	190	52.2	6600
902100	100	488	225	42.3	85	21.8	205	55.5	10500





**ADJUSTABLE WRENCH ALLIGATOR**

- 8" (200mm) adjustable wrench
- Integral measurement scale on the jaw
- Moving jaw does not protrude allowing use in confined spaces
- Incorporates an "alligator" style pipe grip for gripping round objects
- Hole in the handle for tool securing when working at height
- High grade chrome vanadium steel with a black phosphate finish
- Designed and manufactured to: ISO 6787

Item ID: **4003J**

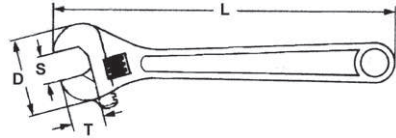

**ADJUSTABLE WRENCH**

- Integral measurement scale on the jaw
- Moving jaw does not protrude allowing use in confined spaces
- Hole in the handle for tool securing when working at height
- High grade chrome vanadium steel with a black phosphate finish
- Designed and manufactured to ISO 6787

**ADJUSTABLE WRENCH ALLIGATOR SERVICE KIT**

- Service kit for 4003J adjustable wrench
- Includes replacement pin, knurl and spring

ITEM ID:

4003JRK

ITEM ID:	L	L	Capacity		T	D	ISO	Weight
	mm	AF	mm	AF	mm	mm	Nm	g
4001	100	4"	17	11/16"	14	31	33	50
4002	150	6"	24	15/16"	19	44	85	140
4003	200	8"	28	1-1/8"	26	57	180	260
4004	250	10"	33	1-1/4"	31	68	320	440
4005	300	12"	38	1-1/2"	32	80	515	660
4006	375	15"	50	1-5/16"	44	100	920	1200
4007	450	18"	60	2-3/8"	53	122	1370	2000
4008	600	24"	70	2-3/4"	62	144	-	3700



**TT SERIES** Spanner Sets available

**MODULAR TOOL CONTROL SYSTEM**



**PAGE 68**

**FOAM SERIES** Spanner Sets available

**MODULAR TOOL CONTROL SYSTEM**

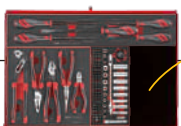

**PAGE 132**

**ADJUSTABLE WRENCH SERVICE KITS**

- Includes replacement pin, knurl and spring

ITEM ID:	Suitable For:
4001RK	4" adjustable wrench - 4001
4002RK	6" adjustable wrench - 4002
4003RK	8" adjustable wrench - 4003
4004RK	10" adjustable wrench - 4004
4005RK	12" adjustable wrench - 4005
4006RK	15" adjustable wrench - 4006
4007RK	18" adjustable wrench - 4007
4008RK	24" adjustable wrench - 4008

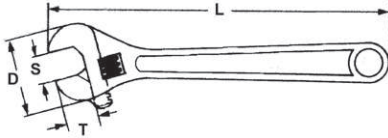

TPR  
GRIP

### ADJUSTABLE WRENCH TPR GRIP

- Integral measurement scale on the jaw
- Moving jaw does not protrude allowing use in confined spaces
- Bi-material handle for extra comfort
- Hole in the handle for tool securing when working at height
- High grade chrome vanadium steel with a black phosphate finish
- Designed and manufactured to: DIN 3117 and ISO 6787

ITEM ID:	L	L	Capacity		T	D	ISO	Weight
	mm	AF	mm	AF	mm	mm	Nm	g
4002IQ	157	6"	24	15/16"	20	52	85	140
4003IQ	206	8"	28	1-1/8"	25.3	62	180	260
4004IQ	255	10"	33	1-1/4"	29.5	72	320	440
4005IQ	305	12"	38	1-1/2"	32.2	83	515	660
4006IQ	380	15"	50	1-15/16"	44.7	108	920	1200

### ADJUSTABLE WRENCH TPR GRIP SERVICE KITS

- Includes replacement pin, knurl and spring

ITEM ID:	Suitable For:
4002IQRK	6" adjustable wrench - 4002IQ
4003IQRK	8" adjustable wrench - 4003IQ
4004IQRK	10" adjustable wrench - 4004IQ
4005IQRK	12" adjustable wrench - 4005IQ
4006IQRK	15" adjustable wrench - 4006IQ

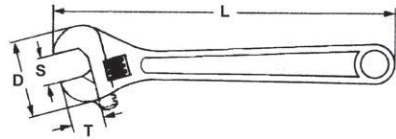

TPR  
GRIP

### ADJUSTABLE WRENCH WIDE JAW

- Integral measurement scale
- Extra wide jaw opening increases the bolt sizes that can be worked on
- Moving jaw does not protrude allowing use in confined spaces
- Bi-material handle for extra comfort
- Hole in the handle for tool securing when working at height
- High grade chrome vanadium steel with a black phosphate finish
- Designed and manufactured to: DIN 3117 and ISO 6787

ITEM ID:	L	L	Capacity		T	D	Weight
	mm	AF	mm	AF	mm	mm	g
4002WT	172	7"	34	1-3/8"	30	63.5	185
4003WT	221	8"	38	1-1/2"	34.1	72.1	260
4004WT	275	10"	50	2"	41	92.1	440
4005WT	317	12"	60	2-3/8"	55.7	110.5	660

### ADJUSTABLE WRENCH WIDE JAW SERVICE KITS

- Includes replacement pin, knurl and spring

ITEM ID:	Suitable For:
4002WTRK	6" adjustable wrench - 4002WT
4003WTRK	8" adjustable wrench - 4003WT
4004WTRK	10" adjustable wrench - 4004WT
4005WTRK	12" adjustable wrench - 4005WT



# SCREWDRIVERS

## More comfort more power

Unlike other brands the TengTools screwdriver blade has steel alloy wings that the plastic handle is moulded around. This allows for greater torque to be put on the screwdriver, ensures the blade is dead straight and stops the blade from moving in the handle.



Size and tip marked at the bottom of each handle for easy identification

Hole in the handle can be used in a fall arrest system, for storage and for use as a T-handle

The bi-material handle is designed for increased comfort and smooth action preventing blisters after continuous use. It gives better support and increased power transfer.

The soft black material prevents the screwdriver from sticking in the hand allowing for rapid movement

The red resistant plastic is used for the core and ensures the blade is held securely

Size marked on shaft for identification while in use

Shaft made from TengTools TT-MV PLUS steel alloy for greater strength and material flexibility

Magnetic tip designed to maximise torque transfer and reduce wear

Designed and manufactured to DIN and ISO industrial standards

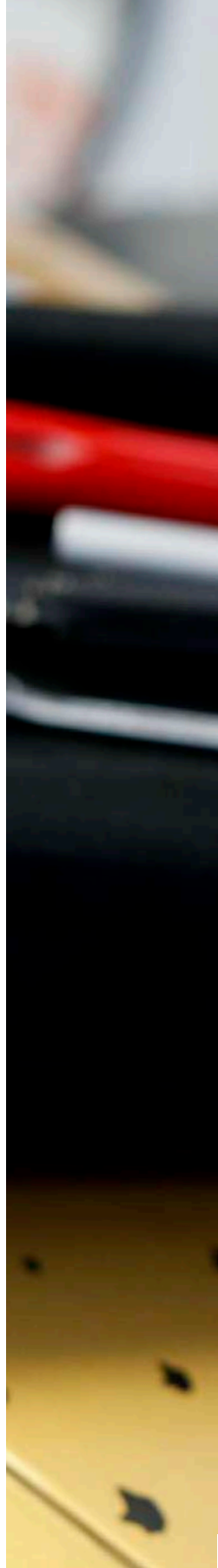

Get Organised™





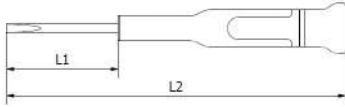

**FLAT MINI SCREWDRIVER**

- CrMo steel alloy for greater strength
- Rotating end piece for easier use when "transporting" the fastening

ITEM ID:		Shaft	Tip	L1 mm	L2 mm	Weight g
MDM713	2	Round	Parallel	40	122	12
MDM714	2.4	Round	Parallel	40	122	12
MDM715	3	Round	Parallel	40	122	12

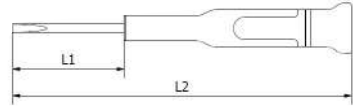

**TX MINI SCREWDRIVER**

- CrMo steel alloy for greater strength
- Rotating end piece for easier use when "transporting" the fastening

ITEM ID:		Shaft	Tip	L1 mm	L2 mm	Weight g
MDM806	TX6	Round	TX	40	122	12
MDM807	TX7	Round	TX	40	122	12
MDM808	TX8	Round	TX	40	122	12
MDM809	TX9	Round	TX	40	122	12
MDM810	TX10	Round	TX	40	122	12
MDM815	TX15	Round	TX	40	122	12

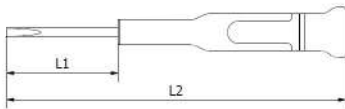

**PH MINI SCREWDRIVER**

- CrMo steel alloy for greater strength
- Rotating end piece for easier use when "transporting" the fastening

ITEM ID:		Shaft	Tip	L1 mm	L2 mm	Weight g
MDM716	PH00	Round	Phillips	40	122	12
MDM717	PH0	Round	Phillips	40	122	12
MDM718	PH1	Round	Phillips	40	122	12

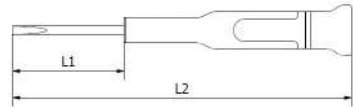

**HEX MINI SCREWDRIVER**

- CrMo steel alloy for greater strength
- Rotating end piece for easier use when "transporting" the fastening



ITEM ID:		Shaft	Tip	L1 mm	L2 mm	Weight g
MDM711	2	Round	Hex	40	122	12
MDM712	2.5	Round	Hex	40	122	12



6 Pieces  

### MINI SCREWDRIVER SET FLAT & PH 6 PIECES

- CrMo steel alloy for greater strength
- Rotating end piece for easier use when "transporting" the fastening
- Supplied in a handy holder that can be wall mounted or used as a stand

Mini Screwdrivers:				
	mm:	2.0x40	2.4x40	3.0x40
	mm:	PH00x40	PH0x40	PH1x40

Item ID: **MDM706**



6 Pieces  

### MINI SCREWDRIVER SET TX 6 PIECES

- CrMo steel alloy for greater strength
- Rotating end piece for easier use when "transporting" the fastening
- Supplied in a handy holder that can be wall mounted or used as a stand















Mini Screwdrivers:				
	mm:	TX6 x 40	TX7 x 40	TX8 x 40
		TX9 x 40	TX10 x 40	TX15 x 40

Item ID: **MDM706TX**



### MINI SCREWDRIVER HANDLE

- Mini screwdriver handle
- For use with double ended mini screwdriver blades
- Twist grip tightening function allows the blade to be set at different lengths, ideal for where access is restricted
- Rotating end piece for easier use when "transporting" the fastening





ITEM ID:	TIP 1	SIZE 1	TIP 2	SIZE 2
MDM700	MINI SCREWDRIVER BLADE HANDLE			
2912512		PH00		2
2912513		PH0		3
2912514		PH1		4
2912520		PZ0		PZ1
2912535		TX5		TX7
2912537		TX6		TX8
2912539		TX9		TX10



8 Pieces  

### MINI SCREWDRIVER SET MIXED 8 PIECES

- Includes fully interchangeable double ended blades
- Sizes clearly marked on the shaft
- Hexagon shaft
- Twist grip tightening function allows the blade to be set at different lengths, ideal for where access is restricted
- Rotating end piece for easier use when "transporting" the fastening

Mini Screwdriver blade handle					
Screwdrivers Blades:					
		mm:	PH00 - 2.0	PH0 - 3.0	PH1 - 4.0
			PZ0 - PZ1		
			TX5 - TX7	TX6 - TX8	TX9 - TX10

Item ID: **TM708**





**MINI TX KEY**

- CrMo steel alloy for greater strength
- Rotating end piece for easier use when "transporting" the fastening

ITEM ID:		Tip	Weight g
MDM806T	TX6	TX	10
MDM807T	TX7	TX	10
MDM808T	TX8	TX	10
MDM809T	TX9	TX	15
MDM810T	TX10	TX	15
MDM815T	TX15	TX	15



**MINI TX T-HANDLE SCREWDRIVER SET 6 PIECES**

- Especially designed bi-material handle for easier use
- Rotating end piece for easier use when "transporting" the fastening
- Supplied in a handy holder that can be wall mounted

Mini T Handle Screwdrivers:			
	TX6	TX7	TX8
	TX9	TX10	TX15

Item ID: **MDM706TXT**

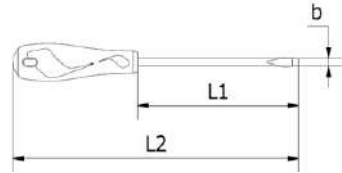

**FLAT MINI SCREWDRIVER POCKET CLIP**

- TT-MV PLUS steel alloy for greater strength and material flexibility
- Ergonomically designed bi-material handle for easy use with higher torque and faster speed
- Pocket clip
- Hole in the handle for hanging or for use with a fall protection wire if needed
- The handle is moulded around the blade to ensure straightness and to allow larger blade wings which give a higher torque capacity

ITEM ID:	b mm	L1 mm	L2 mm	Weight g
MDMC718N	3	50	120	12

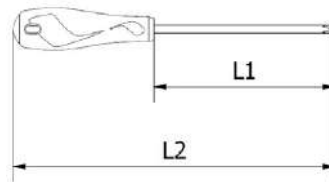

**PH MINI SCREWDRIVER POCKET CLIP**

- TT-MV PLUS steel alloy for greater strength and material flexibility
- Ergonomically designed bi-material handle for easy use with higher torque and faster speed
- Pocket clip
- Hole in the handle for hanging or for use with a fall protection wire if needed
- The handle is moulded around the blade to ensure straightness and to allow larger blade wings which give a higher torque capacity
- DIN ISO 8764

ITEM ID:		Tip	L1 mm	L2 mm	Weight g
MDMC715N	PH1	Phillips	50	120	12





2 Pieces  

**SCREWDRIVER SET FLAT & PH 2 PIECES**

- TT-MV PLUS steel alloy for greater strength and material flexibility
- Ergonomically designed bi-material handles for easy use with higher torque and faster speed
- Pocket clip
- Hole in the handle for hanging or for use with a fall protection wire if needed
- The handle is moulded around the blade to ensure straightness and to allow larger blade wings which give a higher torque capacity

Screwdrivers:

	mm:	3 x 50
	mm:	PH1 x 50

Item ID: **MDMC702N**



**CHOOSE THE RIGHT HANDLE FOR THE RIGHT TASK**

A larger type of handle allows for more power and force to be executed with the driver while a smaller type of handle make it easier to work quickly as less force is required with the driver.



**TT**  
SERIES Screwdriver Sets available

**MODULAR TOOL CONTROL SYSTEM**



**PAGE 74**

**FOAM**  
SERIES Screwdriver Sets available

**MODULAR TOOL CONTROL SYSTEM**



**PAGE 136**



## Do's and Dont's of Screwdrivers

### DO'S

- Use the right tip
- Keep it clean & dry
- Apply extra torque correctly
- Choose the right handle

### DONT'S

- Do not use the wrong tip
- Do not use the screwdriver as a lever
- Do not use on live electric
- Do not use too much power

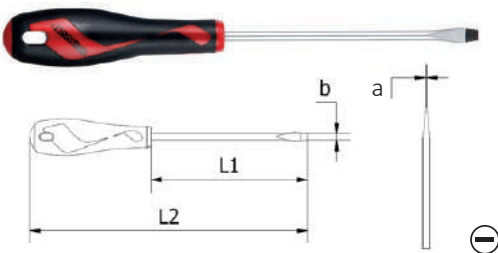

### FLAT SCREWDRIVER

- TT-MV PLUS steel alloy for greater strength and material flexibility
- Ergonomically designed bi-material handle for easy use with higher torque and faster speed
- Hole in the handle for hanging or for use as a T handle for extra torque or with a fall protection wire if needed
- The handle is moulded around the blade to ensure straightness and to allow larger blade wings which give a higher torque capacity
- Designed and manufactured to DIN 2380

ITEM ID:	a mm	b mm	Shaft	Tip	L1 mm	L2 mm	Weight g	HDL
MD914N	0.4	2.5	Round	Parallel	50	146	24	S
MD915N	0.5	2.5	Round	Parallel	75	171	24	S
MD915N1	0.5	2.5	Round	Parallel	200	296	25	S
MD920N	0.5	3	Round	Parallel	75	171	27	S
MD920N1	0.5	3	Round	Parallel	100	196	31	S
MD916N	0.6	3.5	Round	Parallel	75	171	29	S
MD916N1	0.6	3.5	Round	Parallel	100	196	31	S
MD916N2	0.6	3.5	Round	Parallel	150	246	38	S

ITEM ID:	a mm	b mm	Shaft	Tip	L1 mm	L2 mm	Weight g	HDL
MD917N	0.8	4	Round	Parallel	100	196	31	S
MD917N1	0.8	4	Round	Parallel	400	496	41	S
MD917N2	0.8	4	Round	Parallel	150	246	38	S
MD922N	1	5.5	Round	Flared	75	246	38	S
MD923N	1	5.5	Round	Flared	150	258	64	M
MD923N1	1	5.5	Round	Flared	200	308	74	M
MD928N	1.2	6.5	Round	Flared	38	96	45	XS
MD928N1	1.2	6.5	Round	Flared	100	216	93	L
MD928N2	1.2	6.5	Round	Flared	150	266	105	L
MD928N3	1.2	6.5	Round	Flared	200	316	115	L
MD928N4	1.2	6.5	Round	Flared	100	208	105	M
MD928N5	1.2	6.5	Round	Flared	150	258	110	M
MD928N6	1.2	6.5	Round	Flared	200	308	113	M
MD928N7	1.2	6.5	Round	Flared	400	508	185	M
MD930N	1.6	10	Round	Flared	200	325	231	XL
MD931N	1	5.5	Hex	Flared	125	241	96	L
MD932N	1.2	6.5	Hex	Flared	100	216	101	L
MD932N1	1.2	6.5	Hex	Flared	150	266	114	L
MD934N	1.2	8	Hex	Flared	150	275	156	XL
MD935N	1.6	10	Hex	Flared	200	325	226	XL

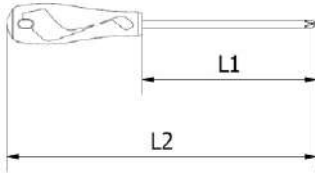

### PH SCREWDRIVER

- TT-MV PLUS steel alloy for greater strength and material flexibility
- Ergonomically designed bi-material handle for easy use with higher torque and faster speed
- Hole in the handle for hanging or for use as a T handle for extra torque or with a fall protection wire if needed
- The handle is moulded around the blade to ensure straightness and to allow larger blade wings which give a higher torque capacity
- Designed and manufactured to DIN ISO 8764

ITEM ID:		Shaft	Tip	L1 mm	L2 mm	Weight g	HDL
MD940N	PH0	Round	Phillips	75	171	27	S
MD940N1	PH0	Round	Phillips	300	396	41	S
MD947N	PH1	Round	Phillips	38	96	40	XS
MD947N1	PH1	Round	Phillips	75	183	29	M
MD948N	PH2	Round	Phillips	38	96	46	XS
MD948N1	PH2	Round	Phillips	100	216	93	L
MD948N2	PH2	Round	Phillips	200	316	115	L
MD948N3	PH2	Round	Phillips	400	516	153	L
MD948N4	PH2	Round	Phillips	100	208	90	M
MD948N5	PH2	Round	Phillips	200	308	110	M
MD948N6	PH2	Round	Phillips	400	508	148	M
MD948N8	PH2	Round	Phillips	300	408	114	M
MD949N	PH3	Round	Phillips	150	275	152	XL
MD950N	PH4	Round	Phillips	200	325	261	XL
MD952N	PH2	Hex	Phillips	100	216	101	L
MD952N1	PH2	Hex	Phillips	400	516	181	L
MD953N	PH3	Hex	Phillips	150	275	159	XL
MD954N	PH4	Hex	Phillips	200	325	231	XL

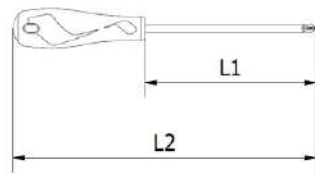

### PZ SCREWDRIVER

- TT-MV PLUS steel alloy for greater strength and material flexibility
- Ergonomically designed bi-material handle for easy use with higher torque and faster speed
- Hole in the handle for hanging or for use as a T handle for extra torque or with a fall protection wire if needed
- The handle is moulded around the blade to ensure straightness and to allow larger blade wings which give a higher torque capacity
- Designed and manufactured to DIN ISO 8764

ITEM ID:		Shaft	Tip	L1 mm	L2 mm	Weight g	HDL
MD960N	PZ0	Round	Pozi	75	171	27	S
MD961N	PZ1	Round	Pozi	75	183	29	M
MD961N1	PZ1	Round	Pozi	250	358	73	M
MD961N2	PZ1	Round	Pozi	38	96	40	XS
MD962N	PZ2	Round	Pozi	100	216	93	L
MD962N1	PZ2	Round	Pozi	150	266	105	L
MD962N2	PZ2	Hex	Pozi	100	216	101	L
MD962N3	PZ2	Round	Pozi	38	96	45	XS
MD962N4	PZ2	Round	Pozi	100	208	98	M
MD962N5	PZ2	Round	Pozi	150	258	100	M
MD962N4A	PZ2	Round	Pozi	200	308	93	M
MD962N4C	PZ2	Round	Pozi	300	408	93	M
MD962N4D	PZ2	Round	Pozi	400	508	93	M
MD963N	PZ3	Hex	Pozi	150	275	158	XL
MD964N	PZ4	Hex	Pozi	200	325	231	XL



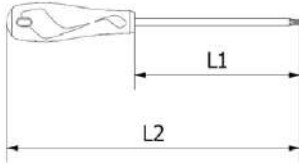

**TX SCREWDRIVER**

- TT-MV PLUS steel alloy for greater strength and material flexibility
- Ergonomically designed bi-material handle for easy use with higher torque and faster speed
- Hole in the handle for hanging or for use as a T handle for extra torque or with a fall protection wire if needed
- The handle is moulded around the blade to ensure straightness and to allow larger blade wings which give a higher torque capacity

ITEM ID:	Shaft	Tip	L1 mm	L2 mm	Weight g	HDL	
MD906TN	TX6	Round	TX	75	171	29	S
MD907TN	TX7	Round	TX	75	171	29	S
MD908TN	TX8	Round	TX	75	171	29	S
MD909TN	TX9	Round	TX	75	171	29	S
MD910TN	TX10	Round	TX	100	208	58	M
MD915TN	TX15	Round	TX	100	208	58	M
MD920TN	TX20	Round	TX	100	208	58	M
MD925TN	TX25	Round	TX	100	216	93	L
MD927TN	TX27	Round	TX	100	216	94	L
MD930TN	TX30	Round	TX	100	216	94	L
MD940TN	TX40	Round	TX	100	216	106	L
MD945TN	TX45	Round	TX	125	250	237	XL

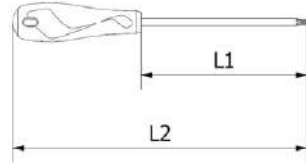

**TPX SCREWDRIVER**

- For use with tamper proof TX fastenings
- TT-MV PLUS steel alloy for greater strength and material flexibility
- Ergonomically designed bi-material handle for easy use with higher torque and faster speed
- Hole in the handle for hanging or for use as a T handle for extra torque or with a fall protection wire if needed
- The handle is moulded around the blade to ensure straightness and to allow larger blade wings which give a higher torque capacity

ITEM ID:	Shaft	Tip	L1 mm	L2 mm	Weight g	HDL	
MD610TPN	TPX10	Round	TPX	100	208	58	M
MD615TPN	TPX15	Round	TPX	100	208	58	M
MD620TPN	TPX20	Round	TPX	100	208	58	M
MD625TPN	TPX25	Round	TPX	100	216	94	L
MD627TPN	TPX27	Round	TPX	100	216	94	L
MD630TPN	TPX30	Round	TPX	100	216	94	L
MD640TPN	TPX40	Round	TPX	100	216	105	L



**TT SERIES** Screwdriver Sets available

**MODULAR TOOL CONTROL SYSTEM**



**PAGE 74**

**FOAM SERIES** Screwdriver Sets available

**MODULAR TOOL CONTROL SYSTEM**



**PAGE 136**

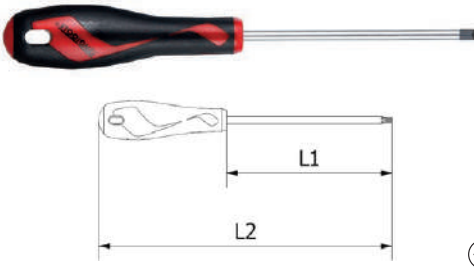

### HEX SCREWDRIVER

- For use with hexagon fastenings and grub screws
- TT-MV PLUS steel alloy for greater strength and material flexibility
- Ergonomically designed bi-material handle for easy use with higher torque
- Hole in the handle for hanging or for use as a T handle for extra torque
- The handle is moulded around the blade to ensure straightness

ITEM ID:	Shaft	Tip	L1 mm	L2 mm	HDL	
MD7020HN	2	Round	Hex	100	196	S
MD7030HN	3	Round	Hex	100	196	S

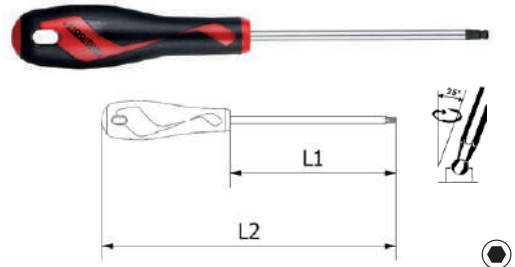

### BALL POINT HEX SCREWDRIVER

- Ball point head allows turning at angles up to 25° for easier access
- For use with hexagon fastenings and grub screws
- TT-MV PLUS steel alloy for greater strength and material flexibility
- Ergonomically designed bi-material handle for easy use with higher torque
- Hole in the handle for hanging or for use as a T handle for extra torque
- The handle is moulded around the blade to ensure straightness

ITEM ID:	Shaft	Tip	L1 mm	L2 mm	HDL	
MD7020HBN	2	Round	Hex ball	100	196	S
MD7025HBN	2.5	Round	Hex ball	100	196	S
MD7030HBN	3	Round	Hex ball	150	246	S
MD7040HBN	4	Round	Hex ball	150	258	M
MD7050HBN	5	Round	Hex ball	150	266	L
MD7060HBN	6	Round	Hex ball	150	266	L
MD7080HBN	8	Round	Hex ball	150	275	XL

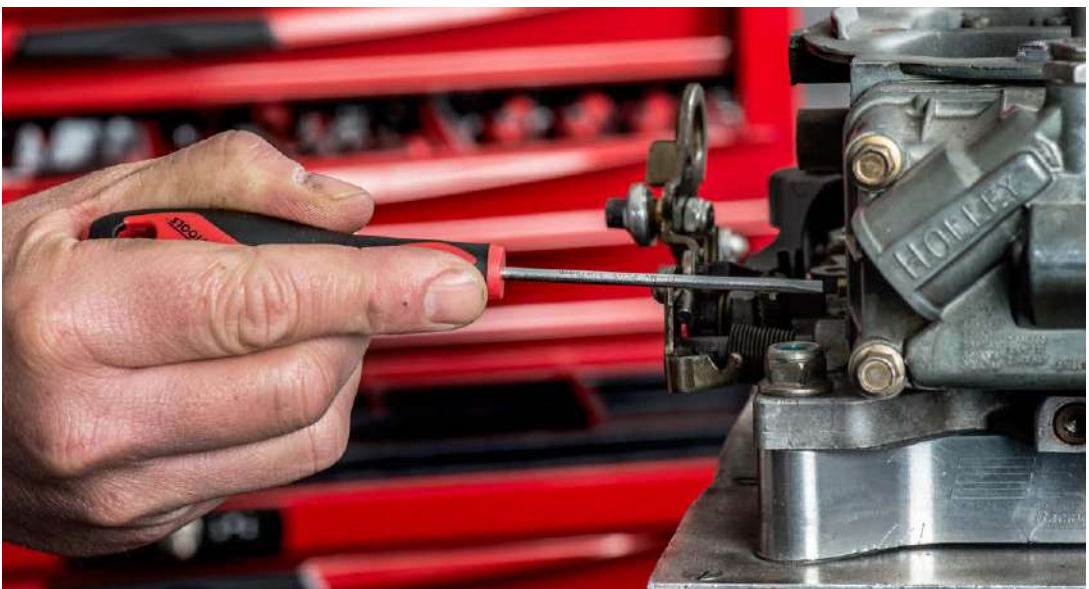



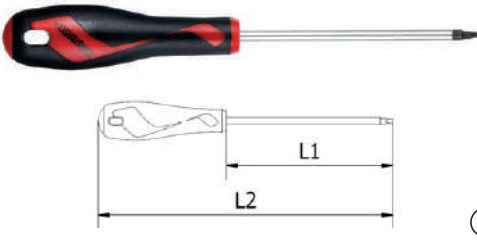

**ROB SCREWDRIVER**

- TT-MV PLUS steel alloy for greater strength and material flexibility
- Ergonomically designed bi-material handle for easy use with higher torque and faster speed
- Hole in the handle for hanging or for use as a T handle for extra torque or with a fall protection wire if needed
- The handle is moulded around the blade to ensure straightness and to allow larger blade wings which give a higher torque capacity

ITEM ID:		Shaft	Tip	L1 mm	L2 mm	Weight g	HDL
MD801N	1	Round	ROB	100	216	94	L
MD802N	2	Round	ROB	100	216	94	L
MD803N	3	Round	ROB	100	216	94	L

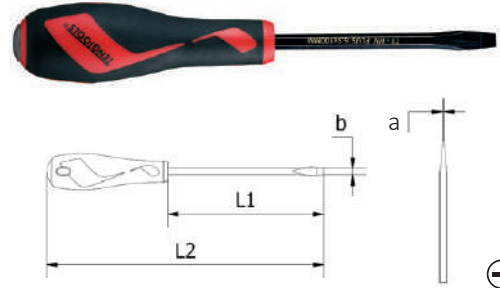

**FLAT POWER THRU SCREWDRIVER**

- Percussion cap and power through blade for striking with a hammer
- Ergonomically designed bi-material handle for easy use with higher torque and faster speed
- The hexagonal shaft allows tightening with an open ended spanner for extra torque if needed
- Designed and manufactured to DIN 2380

ITEM ID:	a mm	b mm	Shaft	Tip	L1 mm	L2 mm	Weight g	HDL
MDT932N	1.2	6.5	Hex	Flared	100	216	120	L
MDT934N	1.2	8	Hex	Flared	150	275	200	XL
MDT935N	1.6	10	Hex	Flared	200	325	200	XL



**DOUBLE ENDED SCREWDRIVER BLADE**

- Double ended screwdriver blade giving two tools in one
- Hexagon shaft enabling a wrench to be used for added control and torque
- TT-MV PLUS steel alloy for greater strength and material flexibility
- Sizes clearly marked on the shaft

ITEM ID:	TIP 1	SIZE 1	TIP 2	SIZE 2
MD901	SCREWDRIVER BLADE HANDLE			
PZZ0102		PZ1		PZ2
PHH0102		PH1		PH2
FTF4055		4		5.5
PHF0365		PH3		6.5
TXX1015		TX10		TX15
TXX2025		TX20		TX25
TXX3040		TX30		TX40
HBH0303		3 Ball		3
HBH0404		4 Ball		4
HBH0505		5 Ball		5
HBH0606		6 Ball		6

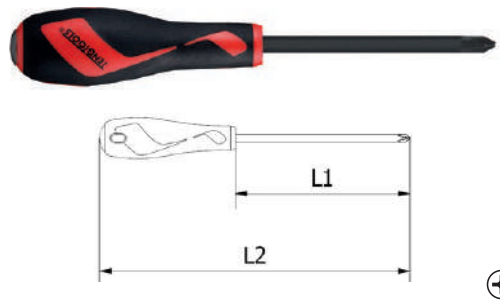

**PH POWER THRU SCREWDRIVER**

- Percussion cap and power through blade for striking with a hammer
- Ergonomically designed bi-material handle for easy use with higher torque and faster speed
- The hexagonal shaft allows tightening with an open ended spanner for extra torque if needed
- Designed and manufactured to DIN ISO 8764

ITEM ID:		Shaft	Tip	L1 mm	L2 mm	Weight g	HDL
MDT952N	PH2	Hex	Phillips	100	216	120	L
MDT953N	PH3	Hex	Phillips	150	275	200	XL

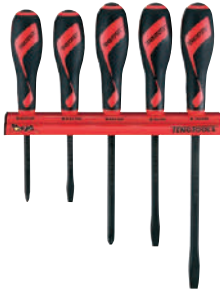

5 Pieces

### POWER THROUGH SCREWDRIVER WALL RACK

- Chrome vanadium blades for greater strength
- Percussion cap and full length integral blade for use with a hammer
- Ergonomically designed bi-material handle for easy use with higher torque
- The handle is moulded around the blade to ensure straightness
- Supplied with a wall rack for fixing to the wall or a workbench

Power Through Screwdrivers:

⊖	mm:	6.5 x 100	8 x 150	10 x 200
⊕	mm:	PH2 x 100	PH3 x 150	

Item ID: **WRMDT05N**



### NUT DRIVER

- Single hexagon 6 point socket
- Screwdriver type handle for use with hexagon nuts and bolts
- Chrome vanadium steel alloy for greater strength
- Ergonomically designed bi-material handle for higher torque
- Hole in the handle for hanging or for use as a T handle for extra torque
- The handle is moulded around the blade to give a higher torque capacity
- Designed and manufactured to DIN3125

ITEM ID:	Size mm	Shaft Length	Overall Length	Weight g
MDN505	5	125	234	91
MDN5055	5.5	125	234	93
MDN506	6	125	234	93
MDN507	7	125	234	98
MDN508	8	125	234	102
MDN510	10	125	242	130
MDN511	11	125	242	153
MDN512	12	125	242	153
MDN513	13	125	242	160



### T HANDLE NUT DRIVER

- Single hexagon 6 point socket
- T handle type driver for use with hexagon nuts and bolts
- Chrome vanadium steel alloy for greater strength
- Ergonomically designed bi-material handle for higher torque
- Hole in the handle for hanging or for use with a fall protection wire
- Designed and manufactured to DIN3125

ITEM ID:	Size mm	Overall Length
MDNT405	5	288
MDNT4055	5.5	288
MDNT406	6	288
MDNT407	7	288
MDNT408	8	288
MDNT409	9	288
MDNT410	10	288
MDNT411	11	288
MDNT412	12	288
MDNT413	13	288
MDNT414	14	288



### MAGNETIC SCREWDRIVER CHARGER

- Magnetic screwdriver charger and discharger
- Use to magnetise or demagnetise screwdrivers
- Supplied on a handy key ring

Item ID: **MR500**



**SCREWDRIVER SET MIXED 53 PIECES**

- TT-MV PLUS steel alloy for greater strength and material flexibility
- Ergonomically designed bi-material handle for easy use with higher torque and faster speed
- Hole in the handle for hanging or for use as a T handle for extra torque or with a fall protection wire if needed
- The handle is moulded around the blade to ensure straightness and to allow larger blade wings which give a higher torque capacity
- Includes Ratcheting bits driver with 1/4" hex drive 25mm length bits
- Bits range includes Flat, PH, PZ, TX, TPX, ROB and hexagon sizes
- Supplied in a handy carrying case



1/4" hex x 1/4" square drive adaptor					
Screwdrivers:					
-	mm:	3.0 x 75	3.0 x 100	4.0 x 100	5.5 x 75
		5.5 x 150	6.0 x 38	6.5 x 100	6.5 x 150
		8.0 x 150	10.0 x 200		
+	mm:	PH1 x 75	PH2 x 38	PH2 x 100	PH3 x 150
	mm:	PZ0 x 75	PZ1 x 75	PZ2 x 38	PZ2 x 100
		PZ3 x 150			
Ratcheting Bits Driver					
25 mm BITS:					
-	mm:	1.2 x 5	1.4 x 7		
		PH1	PH2		
+		PZ0	PZ1	PZ2	
		TX6	TX7	TX8	TX9
		TX10	TX15 (x2)	TX20 (x2)	TX25 (x2)
		TX30	TX40		
*		TPX20	TPX25	TPX30	
		ROB1	ROB2	ROB3	
●	mm:	2	3	4	5
		6	8		

Item ID: MD9053N



**SCREWDRIVER SET MIXED 10 PIECES**

- Includes 1,000 volt insulated 3.0mm flat blade screwdriver
- TT-MV PLUS steel alloy for greater strength and material flexibility
- Ergonomically designed bi-material handle for easy use with higher torque and faster speed
- Hole in the handle for hanging or for use as a T handle for extra torque or with a fall protection wire if needed
- The handle is moulded around the blade to ensure straightness and to allow larger blade wings which give a higher torque capacity
- Supplied in a handy carrying case

Screwdrivers:					
-	mm:	3.0 x 100	5.5 x 75	5.5 x 150	6.5 x 150
		3.0 x 100			
+	mm:	PH0 x 75	PH1 x 75	PH2 x 100	
	mm:	PZ1 x 75	PZ2 x 100		

Item ID: MD910N



### SCREWDRIVER SET MIXED 11 PIECES

- TT-MV PLUS steel alloy for greater strength and material flexibility
- Ergonomically designed bi-material handle for easy use with higher torque and faster speed
- Hole in the handle for hanging or for use as a T handle for extra torque or with a fall protection wire if needed
- The handle is moulded around the blade to ensure straightness and to allow larger blade wings which give a higher torque capacity
- Supplied in a handy carrying case

#### Screwdrivers:

-	mm:	3 x 100	5.5 x 75	5.5 x 150	6.5 x 38
		6.5 x 150			
+	mm:	PH0 x 75	PH1 x 75	PH2 x 38	PH2 x 100
	mm:	PZ1 x 75	PZ2 x 100		

Item ID: **MD911N**



### SCREWDRIVER SET FLAT 5 PIECES

- TT-MV PLUS steel alloy for greater strength and material flexibility
- Ergonomically designed bi-material handle for easy use with higher torque and faster speed
- Hole in the handle for hanging or for use as a T handle for extra torque or with a fall protection wire if needed
- The handle is moulded around the blade to ensure straightness and to allow larger blade wings which give a higher torque capacity
- Supplied in a full colour display box with PS tray

#### Screwdrivers:

-	mm:	2.5 x 50	3 x 75
		4 x 100	5.5 x 150
		6.5 x 150	

Item ID: **MD906N5**



### SCREWDRIVER SET MIXED 6 PIECES

- TT-MV PLUS steel alloy for greater strength and material flexibility
- Ergonomically designed bi-material handle for easy use with higher torque and faster speed
- Hole in the handle for hanging or for use as a T handle for extra torque or with a fall protection wire if needed
- The handle is moulded around the blade to ensure straightness and to allow larger blade wings which give a higher torque capacity
- Supplied in a full colour display box with PS tray

#### Screwdrivers:

-	mm:	3 x 75	5.5 x 100
+	mm:	PH1 x 75	PH2 x 100
*	mm:	PZ1 x 75	PZ2 x 100

Item ID: **MD906N**



### SCREWDRIVER SET FLAT & PH 6 PIECES

- TT-MV PLUS steel alloy for greater strength and material flexibility
- Ergonomically designed bi-material handle for easy use with higher torque and faster speed
- Hole in the handle for hanging or for use as a T handle for extra torque or with a fall protection wire if needed
- The handle is moulded around the blade to ensure straightness and to allow larger blade wings which give a higher torque capacity
- Supplied in a full colour display box with PS tray

Screwdrivers:

⊖	mm:	3 x 75	4 x 100	5.5 x 75	6.5 x 100
⊕	mm:	PH1 x 75	PH2 x 100		

Item ID: **MD906N3**



### SCREWDRIVER SET TX 6 PIECES

- TT-MV PLUS steel alloy for greater strength and material flexibility
- Ergonomically designed bi-material handle for easy use with higher torque and faster speed
- Hole in the handle for hanging or for use as a T handle for extra torque or with a fall protection wire if needed
- The handle is moulded around the blade to ensure straightness and to allow larger blade wings which give a higher torque capacity
- Supplied in a full colour display box with PS tray

Screwdrivers:

★	mm:	TX10 x 100	TX15 x 100	TX20 x 100
		TX25 x 100	TX30 x 100	TX40 x 100

Item ID: **MD906N1**



### SCREWDRIVER SET FLAT & PZ 6 PIECES

- TT-MV PLUS steel alloy for greater strength and material flexibility
- Ergonomically designed bi-material handle for easy use with higher torque and faster speed
- Hole in the handle for hanging or for use as a T handle for extra torque or with a fall protection wire if needed
- The handle is moulded around the blade to ensure straightness and to allow larger blade wings which give a higher torque capacity
- Supplied in a full colour display box with PS tray

Screwdrivers:

⊖	mm:	3 x 75	4 x 100	5.5 x 75	6.5 x 100
⊕	mm:	PZ1 x 75	PZ2 x 100		

Item ID: **MD906N4**



**SCREWDRIVER SET MIXED 12 PIECES**

- TT-MV PLUS steel alloy for greater strength and material flexibility
- Ergonomically designed bi-material handle for easy use with higher torque and faster speed
- Hole in the handle for hanging or for use as a T handle for extra torque or with a fall protection wire if needed
- The handle is moulded around the blade to ensure straightness and to allow larger blade wings which give a higher torque capacity
- Supplied in a full colour display box with PS tray

Screwdrivers:

⊖	mm:	2.5 x 75	3.5 x 100	4 x 150	5.5 x 150
		6.5 x 150	10 x 200		
⊕	mm:	PH0 x 75	PH1 x 75	PH2 x 100	PH2 x 200
⊕	mm:	PZ1 x 75	PZ2 x 100		

Item ID: **MD912N**



**TT**  
SERIES Screwdriver Sets available

**MODULAR TOOL CONTROL SYSTEM**



**PAGE 74**

**FOAM**  
SERIES Screwdriver Sets available

**MODULAR TOOL CONTROL SYSTEM**



**PAGE 136**

# BITS & DRIVERS

## Quality you can trust

All TengTools bits with a hexagonal drive are designed and manufactured in accordance with the latest industrial standards. Screwdriver bits and socket bits are classified as consumables and thus are only guaranteed to meet dimensional standards.

An extensive range of bit drivers are available in the range including ratcheting drivers, stubby drivers and folding handle drivers for greater power transfer. A selection of drivers offer the option of storing bits in the handle so you do not have to waste time searching for bits when you need them.



Bit sets supplied in handy pocket sized storage with bits that are easy to access. More belt clip sets have been added to the range to help you keep small tool sets in arms reach at all times.



Get Organised™

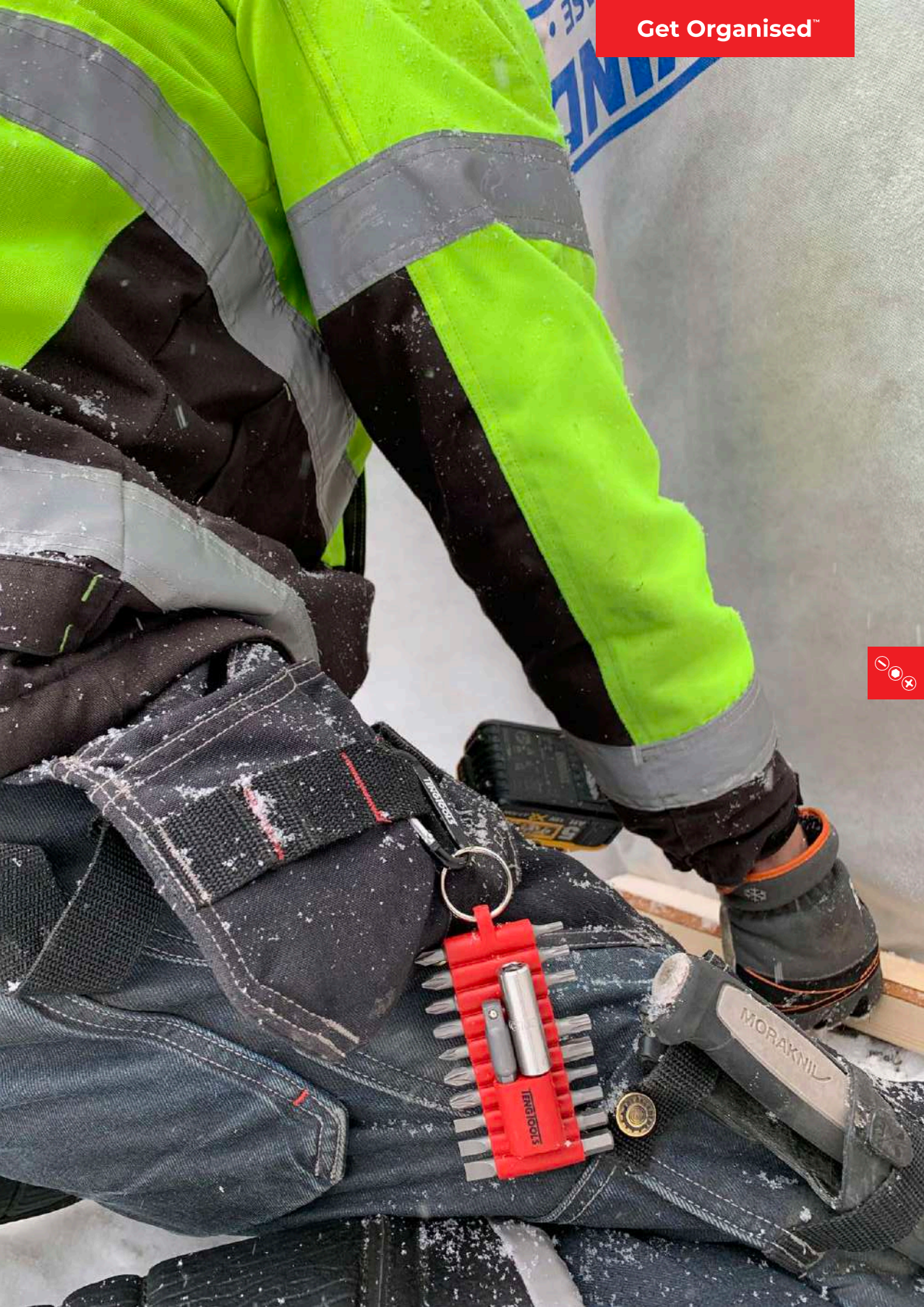





**1/4" DOUBLE ENDED FLAT BITS**

- Designed for use with slotted type screws and fastenings
- Ideal for use with rechargeable and electric screwdrivers
- Designed and manufactured to DIN ISO 1173 & DIN ISO 2380

ITEM ID	Size 1 mm	Size 2 mm	Drive	Pack Qty	Length mm
FTF32406005	0.8 x 4	1.2 x 6	1/4" Hex	5	32



**1/4" FLAT BITS 25MM**

- For use with 1/4" hex drive bit holders and accessories
- Designed for use with slotted type screws and fastenings
- Designed and manufactured to DIN ISO 1173 & DIN ISO 2351-1

ITEM ID	Size mm	Drive	Pack Qty	Length mm
FL2506A03	0.6 x 3.5	1/4" Hex	3	25
FL2506B03	0.6 x 4.5	1/4" Hex	3	25
FL2508A03	0.8 x 4	1/4" Hex	3	25
FL2508B03	0.8 x 5.5	1/4" Hex	3	25
FL2510A03	1.0 x 5.5	1/4" Hex	3	25
FL2512A03	1.2 x 6.5	1/4" Hex	3	25
FL2516A03	1.6 x 8	1/4" Hex	3	25



**1/4" FLAT BITS 50MM**

- For use with 1/4" hex drive bit holders and accessories
- Designed for use with slotted type screws and fastenings
- Designed and manufactured to DIN ISO 1173 & DIN ISO 2351-1

ITEM ID	Size mm	Drive	Pack Qty	Length mm
FL5006A03	0.6 x 3.5	1/4" Hex	3	50
FL5008A03	0.8 x 4	1/4" Hex	3	50
FL5008B03	0.8 x 5.5	1/4" Hex	3	50
FL5010A03	1.0 x 5.5	1/4" Hex	3	50
FL5012A03	1.2 x 6.5	1/4" Hex	3	50



**1/4" FLAT BITS 70MM**

- For use with 1/4" hex drive bit holders and accessories
- Designed for use with slotted type screws and fastenings
- Designed and manufactured to DIN ISO 1173 & DIN ISO 2351-1

ITEM ID	Size mm	Drive	Pack Qty	Length mm
FL7006A02	0.6 x 3.5	1/4" Hex	2	70
FL7008A02	0.8 x 4	1/4" Hex	2	70
FL7008B02	0.8 x 5.5	1/4" Hex	2	70
FL7010A02	1.0 x 5.5	1/4" Hex	2	70



**1/4" FLAT BITS 89MM**

- For use with 1/4" hex drive bit holders and accessories
- Designed for use with slotted type screws and fastenings
- Designed and manufactured to DIN ISO 1173 & DIN ISO 2351-1

ITEM ID	Size mm	Drive	Pack Qty	Length mm
FL8905A01	0.5 x 3	1/4" Hex	1	89
FL8908A01	0.8 x 4	1/4" Hex	1	89



**1/4" DOUBLE ENDED PH BITS**

- Designed for use with Phillips type screws and fastenings
- Ideal for use with rechargeable and electric screwdrivers
- Designed and manufactured to DIN ISO 1173 & DIN ISO 8764-1

ITEM ID	Size 1 mm	Size 2 mm	Drive	Pack Qty	Length mm
PHH32000305	PH0	PH3	1/4" Hex	5	32
PHH32010205	PH1	PH2	1/4" Hex	5	32



### 1/4" PH BITS 25MM

- For use with 1/4" hex drive bit holders and accessories
- Designed for use with Phillips type screws and fastenings
- Designed and manufactured to DIN 3126/ISO 1173

ITEM ID	Size mm	Drive	Pack Qty	Length mm
PH2500103	PH1	1/4" Hex	3	25
PH2500110	PH1	1/4" Hex	10	25
PH2500203	PH2	1/4" Hex	3	25
PH2500210	PH2	1/4" Hex	10	25
PH2500303	PH3	1/4" Hex	3	25
PH2500310	PH3	1/4" Hex	10	25



### 1/4" PH BITS 50MM

- For use with 1/4" hex drive bit holders and accessories
- Designed for use with Phillips type screws and fastenings
- Designed and manufactured to DIN 3126/ISO 1173

ITEM ID	Size mm	Drive	Pack Qty	Length mm
PH5000103	PH1	1/4" Hex	3	50
PH5000203	PH2	1/4" Hex	3	50
PH5000303	PH3	1/4" Hex	3	50



### 1/4" PH BITS 70MM

- For use with 1/4" hex drive bit holders and accessories
- Designed for use with Phillips type screws and fastenings
- Designed and manufactured to DIN 3126/ISO 1173

ITEM ID	Size mm	Drive	Pack Qty	Length mm
PH7000102	PH1	1/4" Hex	2	70
PH7000202	PH2	1/4" Hex	2	70



### 1/4" PH BITS 89MM

- For use with 1/4" hex drive bit holders and accessories
- Designed for use with Phillips type screws and fastenings
- Designed and manufactured to DIN 8764-1

ITEM ID	Size mm	Drive	Pack Qty	Length mm
PH8900101	PH1	1/4" Hex	1	89
PH8900201	PH2	1/4" Hex	1	89



### 1/4" PH IMPACT BITS

- Designed for higher torsion
- For use with 1/4" hex drive bit holders and accessories
- Designed for use with Phillips type screws and fastenings

ITEM ID	Size mm	Drive	Pack Qty	Length mm
PHP3000101	PH1	1/4" Hex	1	30
PHP3000105	PH1	1/4" Hex	5	30
PHP3000201	PH2	1/4" Hex	1	30
PHP3000205	PH2	1/4" Hex	5	30
PHP3000301	PH3	1/4" Hex	1	30
PHP3000305	PH3	1/4" Hex	5	30
PHP5000101	PH1	1/4" Hex	1	50
PHP5000201	PH2	1/4" Hex	1	50
PHP5000301	PH3	1/4" Hex	1	50
PHP8900201	PH2	1/4" Hex	1	89



### 1/4" PH2G BITS 25MM

- GR type with reduced neck designed for use with dry wall screws
- For use with 1/4" hex drive bit holders and accessories
- Designed for use with Phillips type screws and fastenings
- Designed and manufactured to DIN 3126/ISO 1173

ITEM ID	Size mm	Drive	Pack Qty	Length mm
GR25002010	PH2G	1/4" Hex	10	25
GR25002100	PH2G	1/4" Hex	100	25





### 1/4" PH2G IMPACT BITS

- Designed for higher torsion
- PH2G type with reduced neck designed for use with dry wall screws
- For use with 1/4" hex drive bit holders and accessories

ITEM ID	Size mm	Drive	Pack Qty	Length mm
GRP3000201	PH2G	1/4" Hex	1	30
GRP3000205	PH2G	1/4" Hex	5	30
GRP5000201	PH2G	1/4" Hex	1	50



### 1/4" PZ BITS 50MM

- For use with 1/4" hex drive bit holders and accessories
- Designed for use with Pozidriv type screws and fastenings
- Designed and manufactured to DIN 3126/ ISO 1173

ITEM ID	Size mm	Drive	Pack Qty	Length mm
PZ5000103	PZ1	1/4" Hex	3	50
PZ5000203	PZ2	1/4" Hex	3	50
PZ5000303	PZ3	1/4" Hex	3	50



### 1/4" DOUBLE ENDED PZ BITS

- Designed for use with Pozidriv type screws and fastenings
- Ideal for use with rechargeable and electric screwdrivers
- Designed and manufactured to DIN3126

ITEM ID	Size 1 mm	Size 2 mm	Drive	Pack Qty	Length mm
PZZ32000305	PZ0	PZ3	1/4" Hex	5	32
PZZ32010205	PZ1	PZ2	1/4" Hex	5	32



### 1/4" PZ BITS 70MM

- For use with 1/4" hex drive bit holders and accessories
- Designed for use with Pozidriv type screws and fastenings
- Designed and manufactured to DIN 3126/ ISO 1173

ITEM ID	Size mm	Drive	Pack Qty	Length mm
PZ7000102	PZ1	1/4" Hex	2	70
PZ7000202	PZ2	1/4" Hex	2	70



### 1/4" PZ BITS 25MM

- For use with 1/4" hex drive bit holders and accessories
- Designed for use with Pozidriv type screws and fastenings
- Designed and manufactured to DIN 3126/ ISO 1173

ITEM ID	Size mm	Drive	Pack Qty	Length mm
PZ2500103	PZ1	1/4" Hex	3	25
PZ2500110	PZ1	1/4" Hex	10	25
PZ2500203	PZ2	1/4" Hex	3	25
PZ2500210	PZ2	1/4" Hex	10	25
PZ2500303	PZ3	1/4" Hex	3	25
PZ2500310	PZ3	1/4" Hex	10	25



### 1/4" PZ BITS 89MM

- For use with 1/4" hex drive bit holders and accessories
- Designed for use with Pozidriv type screws and fastenings
- Designed and manufactured to DIN 3126/ ISO 1173

ITEM ID	Size mm	Drive	Pack Qty	Length mm
PZ8900101	PZ1	1/4" Hex	1	89
PZ8900201	PZ2	1/4" Hex	1	89



### 1/4" PZ IMPACT BITS

- Designed for higher torsion
- For use with 1/4" hex drive bit holders and accessories
- Designed for use with Pozidriv type screws and fastenings

ITEM ID	Size mm	Drive	Pack Qty	Length mm
PZP3000101	PZ1	1/4" Hex	1	30
PZP3000105	PZ1	1/4" Hex	5	30
PZP3000201	PZ2	1/4" Hex	1	30
PZP3000205	PZ2	1/4" Hex	5	30
PZP3000301	PZ3	1/4" Hex	1	30
PZP3000305	PZ3	1/4" Hex	5	30
PZP5000101	PZ1	1/4" Hex	1	50
PZP5000201	PZ2	1/4" Hex	1	50
PZP5000301	PZ3	1/4" Hex	1	50
PZP8900201	PZ2	1/4" Hex	1	89



### 1/4" DOUBLE ENDED TX BITS

- For use with fastenings with an internal TX type hole
- Ideal for use with rechargeable and electric screwdrivers
- Designed and manufactured to DIN ISO 1173

ITEM ID	Size1 mm	Size2 mm	Drive	Pack Qty	Length mm
TXX32101505	TX10	TX15	1/4" Hex	5	32
TXX32202505	TX20	TX25	1/4" Hex	5	32



### 1/4" TX BITS 25MM

- For use with 1/4" hex drive bit holders and accessories
- Designed for use with fastenings with an internal TX type hole
- Designed and manufactured to DIN ISO 1173

ITEM ID	Size mm	Drive	Pack Qty	Length mm
TX2500603	TX6	1/4" Hex	3	25
TX2500703	TX7	1/4" Hex	3	25
TX2500803	TX8	1/4" Hex	3	25
TX2500903	TX9	1/4" Hex	3	25
TX2501003	TX10	1/4" Hex	3	25
TX2501503	TX15	1/4" Hex	3	25
TX2502003	TX20	1/4" Hex	3	25
TX2502503	TX25	1/4" Hex	3	25
TX2502703	TX27	1/4" Hex	3	25
TX2503003	TX30	1/4" Hex	3	25
TX2504003	TX40	1/4" Hex	3	25



### 1/4" TX BITS 50MM

- For use with 1/4" hex drive bit holders and accessories
- Designed for use with fastenings with an internal TX type hole
- Designed and manufactured to DIN ISO 1173

ITEM ID	Size mm	Drive	Pack Qty	Length mm
TX5000803	TX8	1/4" Hex	3	50
TX5001003	TX10	1/4" Hex	3	50
TX5001503	TX15	1/4" Hex	3	50
TX5002003	TX20	1/4" Hex	3	50
TX5002503	TX25	1/4" Hex	3	50
TX5002703	TX27	1/4" Hex	3	50
TX5003003	TX30	1/4" Hex	3	50



**1/4" TX BITS 70MM**

- For use with 1/4" hex drive bit holders and accessories
- Designed for use with fastenings with an internal TX type hole
- Designed and manufactured to DIN ISO 1173

ITEM ID	Size mm	Drive	Pack Qty	Length mm
TX7001002	TX10	1/4" Hex	2	70
TX7001502	TX15	1/4" Hex	2	70
TX7002002	TX20	1/4" Hex	2	70
TX7002502	TX25	1/4" Hex	2	70



**1/4" TX BITS 89MM**

- For use with 1/4" hex drive bit holders and accessories
- Designed for use with fastenings with an internal TX type hole
- Designed and manufactured to DIN ISO 1173

ITEM ID	Size mm	Drive	Pack Qty	Length mm
TX8901001	TX10	1/4" Hex	1	89
TX8902001	TX20	1/4" Hex	1	89
TX8902501	TX25	1/4" Hex	1	89
TX8903001	TX30	1/4" Hex	1	89



**TT SERIES** Bits & Driver Sets available

**MODULAR TOOL CONTROL SYSTEM**



**PAGE 76**



**1/4" TX IMPACT BITS**

- Designed for higher torsion
- For use with 1/4" hex drive bit holders and accessories
- Designed for use with fastenings with an internal TX hole

ITEM ID	Size mm	Drive	Pack Qty	Length mm
TXP3001001	TX10	1/4" Hex	1	30
TXP3001005	TX10	1/4" Hex	5	30
TXP3001501	TX15	1/4" Hex	1	30
TXP3001505	TX15	1/4" Hex	5	30
TXP3002001	TX20	1/4" Hex	1	30
TXP3002005	TX20	1/4" Hex	5	30
TXP3002501	TX25	1/4" Hex	1	30
TXP3002505	TX25	1/4" Hex	5	30
TXP3002701	TX27	1/4" Hex	1	30
TXP3002705	TX27	1/4" Hex	5	30
TXP3003001	TX30	1/4" Hex	1	30
TXP3003005	TX30	1/4" Hex	5	30
TXP3004001	TX40	1/4" Hex	1	30
TXP3004005	TX40	1/4" Hex	5	30
TXP5001001	TX10	1/4" Hex	1	50
TXP5001501	TX15	1/4" Hex	1	50
TXP5002001	TX20	1/4" Hex	1	50
TXP5002501	TX25	1/4" Hex	1	50
TXP5002701	TX27	1/4" Hex	1	50
TXP5003001	TX30	1/4" Hex	1	50
TXP5004001	TX40	1/4" Hex	1	50
TXP8902001	TX20	1/4" Hex	1	89
TXP8902501	TX25	1/4" Hex	1	89
TXP8903001	TX30	1/4" Hex	1	89

**FOAM SERIES** Bits & Driver Sets available

**MODULAR TOOL CONTROL SYSTEM**



**PAGE 140**

**TX BITS 40MM**

- 10/12 mm hexagon drive for use with appropriate bit holders
- Designed for use with fastenings with a TX hole
- Designed and manufactured to DIN ISO 1173

ITEM ID	Size mm	Drive	Pack Qty	Length mm
220720	TX20	10mm Hex	1	40
220725	TX25	10mm Hex	1	40
220727	TX27	10mm Hex	1	40
220730	TX30	10mm Hex	1	40
220740	TX40	10mm Hex	1	40
220745	TX45	10mm Hex	1	40
220750	TX50	10mm Hex	1	40
220755	TX55	10mm Hex	1	40
220760	TX60	12mm Hex	1	40
220770	TX70	12mm Hex	1	40

**TX BITS 75MM**

- 10/12 mm hexagon drive for use with appropriate bit holders
- Designed for use with fastenings with a TX hole
- Designed and manufactured to DIN ISO 1173

ITEM ID	Size mm	Drive	Pack Qty	Length mm
220820	TX20	10mm Hex	1	75
220825	TX25	10mm Hex	1	75
220827	TX27	10mm Hex	1	75
220830	TX30	10mm Hex	1	75
220840	TX40	10mm Hex	1	75
220845	TX45	10mm Hex	1	75
220850	TX50	10mm Hex	1	75
220855	TX55	10mm Hex	1	75
220860	TX60	12mm Hex	1	75
220870	TX70	12mm Hex	1	75

**1/4" TPX BITS 25MM**

- For use with 1/4" hex drive bit holders and accessories
- Designed for use with fastenings with a tamper proof TPX type hole
- Use with internal TPX heads
- Designed and manufactured to DIN ISO 1173

ITEM ID	Size mm	Drive	Pack Qty	Length mm
TPX2501003	TPX10	1/4" Hex	3	25
TPX2501503	TPX15	1/4" Hex	3	25
TPX2502003	TPX20	1/4" Hex	3	25
TPX2502503	TPX25	1/4" Hex	3	25
TPX2502703	TPX27	1/4" Hex	3	25
TPX2503003	TPX30	1/4" Hex	3	25
TPX2504003	TPX40	1/4" Hex	3	25

**1/4" HEX BITS 25MM**

- For use with 1/4" hex drive bit holders and accessories
- Designed for use with fastenings with a hexagon hole
- Use with in-hex screws or grub screws
- Designed and manufactured to DIN 3126/ ISO 1173

ITEM ID	Size mm	Drive	Pack Qty	Length mm
HEX2500203	2	1/4" Hex	3	25
HEX2500303	3	1/4" Hex	3	25
HEX2500403	4	1/4" Hex	3	25
HEX2500503	5	1/4" Hex	3	25
HEX2500603	6	1/4" Hex	3	25
HEX2500803	8	1/4" Hex	3	25





### 1/4" HEX BITS 50MM

- For use with 1/4" hex drive bit holders and accessories
- Designed for use with fastenings with a hexagon hole
- Use with in-hex screws or grub screws
- Designed and manufactured to DIN 3126 / ISO 1173

ITEM ID	Size mm	Drive	Pack Qty	Length mm
HEX5000403	4	1/4" Hex	3	50
HEX5000503	5	1/4" Hex	3	50
HEX5000603	6	1/4" Hex	3	50
HEX5000803	8	1/4" Hex	3	50



### 1/4" HEX BITS 89MM

- For use with 1/4" hex drive bit holders and accessories
- Designed for use with fastenings with a hexagon hole
- Use with in-hex screws or grub screws
- Designed and manufactured to DIN 3126 / ISO 1173

ITEM ID	Size mm	Drive	Pack Qty	Length mm
HEX8900401	4	1/4" Hex	1	89



### 1/4" HEX IMPACT BITS

- Designed for higher torsion
- For use with 1/4" hex drive bit holders and accessories
- Designed for use with fastenings with a hexagon hole
- Use with in-hex screws or grub screws

ITEM ID	Size mm	Drive	Pack Qty	Length mm
HEXP3000301	3mm	1/4" Hex	1	30
HEXP3000305	3mm	1/4" Hex	5	30
HEXP3000401	4mm	1/4" Hex	1	30
HEXP3000405	4mm	1/4" Hex	5	30
HEXP3000501	5mm	1/4" Hex	1	30
HEXP3000505	5mm	1/4" Hex	5	30
HEXP3000601	6mm	1/4" Hex	1	30
HEXP3000605	6mm	1/4" Hex	5	30
HEXP5000301	3mm	1/4" Hex	1	50
HEXP5000401	4mm	1/4" Hex	1	50
HEXP5000501	5mm	1/4" Hex	1	50
HEXP5000601	6mm	1/4" Hex	1	50



### HEX BITS 40MM

- 10mm/12mm hexagon drive for use with appropriate bit holders
- Designed for use with fastenings with a hexagon hole
- Designed and manufactured to DIN 3126 / ISO 1173

ITEM ID	Size mm	Drive	Pack Qty	Length mm
210705	5	10mm Hex	1	40
210706	6	10mm Hex	1	40
210707	7	10mm Hex	1	40
210708	8	10mm Hex	1	40
210709	9	10mm Hex	1	40
210710	10	10mm Hex	1	40
210712	12	12mm Hex	1	40
210714	14	12mm Hex	1	40
210717	17	12mm Hex	1	40
210719	19	12mm Hex	1	40



### HEX BITS 75MM

- 10mm/12mm hexagon drive for use with appropriate bit holders
- Designed for use with fastenings with a hexagon hole
- Designed and manufactured to DIN 3126 / ISO 1173

ITEM ID	Size mm	Drive	Pack Qty	Length mm
210805	5	10mm Hex	1	75
210806	6	10mm Hex	1	75
210807	7	10mm Hex	1	75
210808	8	10mm Hex	1	75
210809	9	10mm Hex	1	75
210810	10	10mm Hex	1	75
210812	12	12mm Hex	1	75
210814	14	12mm Hex	1	75
210817	17	12mm Hex	1	75
210819	19	12mm Hex	1	75



### 1/4" ROB IMPACT BITS

- Designed for higher torsion
- For use with 1/4" hex drive bit holders and accessories
- Designed for use with ROB recessed heads on screws and fastenings with a square hole

ITEM ID	Size mm	Drive	Pack Qty	Length mm
ROBP3000101	ROB1	1/4" Hex	1	30
ROBP3000105	ROB1	1/4" Hex	5	30
ROBP3000201	ROB2	1/4" Hex	1	30
ROBP3000205	ROB2	1/4" Hex	5	30
ROBP5000101	ROB1	1/4" Hex	1	50
ROBP5000201	ROB2	1/4" Hex	1	50
ROBP5000301	ROB3	1/4" Hex	1	50
ROBP8900101	ROB1	1/4" Hex	1	89
ROBP8900201	ROB2	1/4" Hex	1	89
ROBP8900301	ROB3	1/4" Hex	1	89



### 1/4" ROB BITS 25MM

- For use with 1/4" hex drive bit holders and accessories
- Designed for screws and fastenings with a square hole
- Designed and manufactured to DIN 3126 / ISO 1173

ITEM ID	Size mm	Drive	Pack Qty	Length mm
ROB2500103	ROB1	1/4" Hex	3	25
ROB2500203	ROB2	1/4" Hex	3	25
ROB2500303	ROB3	1/4" Hex	3	25



### 1/4" NUT SETTER

- For use with electric and rechargeable screwdrivers
- Suitable for use on ferrous fastenings

ITEM ID	Size mm	Drive	Type	Length mm
NS45108M	1/4"	1/4" Hex	Magnetic	45
NS45506M	6mm	1/4" Hex	Magnetic	45
NS45507M	7mm	1/4" Hex	Magnetic	45
NS45508M	8mm	1/4" Hex	Magnetic	45
NS45508R	8mm	1/4" Hex	Ring	45



**TT**  
SERIES Bits & Driver Sets available

**MODULAR TOOL CONTROL SYSTEM**



**PAGE 76**

**FOAM**  
SERIES Bits & Driver Sets available

**MODULAR TOOL CONTROL SYSTEM**



**PAGE 140**





### 1/4" IMPACT NUT SETTER

- 1/4" hexagon drive nut setter
- Designed for higher torsion enabling use with power tools such as electric and rechargeable screwdrivers
- Includes a magnet for holding the fastening
- Suitable for use on ferrous fastenings

ITEM ID	Size mm	Drive	Type	Length mm
NSP65108	1/4"	1/4" Hex	Magnetic	65
NSP65507	7mm	1/4" Hex	Magnetic	65
NSP65508	8mm	1/4" Hex	Magnetic	65
NSP65510	10mm	1/4" Hex	Magnetic	65
NSP65513	13mm	1/4" Hex	Magnetic	65



### 1/4" MAGNETIC BIT HOLDER

- Bits holders with magnetic fittings

ITEM ID	Size mm	Holder	Length mm
ACC50MBH01	1/4" Hex	Magnetic	50
ACC70MBH01	1/4" Hex	Magnetic	70
ACC35CBH01	1/4" Hex	Chuck	35
ACC50CBH01	1/4" Hex	Chuck	50



### 1/4" MAGNETIC IMPACT BIT HOLDER

- S2 stainless steel for use with 1/4" hex drive impact bits
- Overall length 60mm to reach in to hard to reach places
- Recessed magnet holds the bit as well as fastenings (ferrous materials only)
- Designed for higher torsion

Item ID: MBH114



### 1/4" QUICK CHUCK IMPACT BIT HOLDER

- S2 stainless steel for use with 1/4" hex drive impact bits
- Overall length 60mm to reach in to hard to reach places
- Quick chuck bit holder for quick and easy changing between bits
- Designed for higher torsion

Item ID: QC114



### 1/4" IMPACT BIT ADAPTOR

- 1/4" hexagon drive to 1/4" square drive impact adaptor
- Overall length 50mm to enable access in to recesses
- Enables the use of 1/4" hexagon drive bit drivers with 1/4" drive impact sockets
- Designed for use with power tools such as electric and rechargeable screwdrivers
- Ball bearing socket retainer on the male end to securely grip the socket

ITEM ID:	Length mm	Depth mm	Height mm	Weight g
IBA14	50	8	8	15



### 1/4" BITS DRIVER EXTENSION

- Fixed shaft with quick chuck bits holder
- Rotating collar to lock or unlock the grip on the bit
- Ideal for use in hard to reach places

ITEM ID	Drive	Extension	Length	
			mm	AF
TTMD74-1	1/4" Hex	Fixed	100	4"



### 1/4" FLEXIBLE BITS DRIVER EXTENSION

- Fixed shaft with quick chuck bits holder
- Rotating collar to lock or unlock the grip on the bit
- Ideal for use in hard to reach places

ITEM ID	Drive	Extension	Length	
			mm	AF
TTMD74-2	1/4" Hex	Flexible	150	6"



### 1/4" FLEXIBLE BIT HOLDER

- Flexible wound spring shaft with quick chuck bits holder
- Ideal for use in hard to reach places

ITEM ID	Drive	Extension	Length	
			mm	AF
ACC300CBH01	1/4" Hex	Flexible	300	12"



### 1/4" BIT ADAPTOR MALE

- Adaptor from a 1/4" hex drive to a square socket drive
- Suitable for use with electric and rechargeable screwdrivers
- For use with standard and impact type sockets
- Ball bearing socket retainer on the male end to securely grip the socket

ITEM ID	Hex Drive	Square Drive	Length
			mm
ACCSDA1414	1/4" Hex	1/4"	50
ACCSDA1438	1/4" Hex	3/8"	50
ACCSDA1412	1/4" Hex	1/2"	50



### COUPLER ADAPTORS

- Coupler adaptors for holding various bits
- Chrome vanadium
- Satin finish for a better grip when handling the adaptor
- Retaining spring to hold the bit in place
- Designed and manufactured to DIN 3120
- Supplied with a metal socket clip for use with a socket rail

ITEM ID	Drive	Converts to	Weight
			g
M140060-C	1/4"	1/4" Hex Bits	20
M380060-C	3/8"	1/4" Hex Bits	32
M380061-C	3/8"	10mm Hex Bits	32
M120060-C	1/2"	5/16" Hex Bits	88
M120061-C	1/2"	10mm Hex Bits	56
M120062-C	1/2"	12mm Hex Bits	62
M120063-C	1/2"	1/4" Hex Bits	88



**TT**  
SERIES Bits & Driver Sets available

### MODULAR TOOL CONTROL SYSTEM



**PAGE 76**

**FOAM**  
SERIES Bits & Driver Sets available

### MODULAR TOOL CONTROL SYSTEM



**PAGE 140**



1/4"

**1/4" MINI BITS RATCHET 60 TEETH**

- 1/4" hex drive reversible bits ratchet
- Overall length 90mm making it very compact and easy to keep in the pocket
- Flip reverse mechanism for quickly changing between tightening and loosening
- Chrome vanadium satin finish drop forged steel
- For use with 1/4" drive hex bits
- 8mm double hexagon ring spanner on the other end

Item ID: **1400B**



1/4"

**1/4" RATCHET HEAD HEX**

- Fine tooth mini ratchet head
- Designed for use together with any 1/4" hex drive bit holder
- 1/4" square drive for use with sockets and accessories
- 1/4" hexagon drive for use with screwdriver bits and accessories
- 72 teeth for use in confined spaces
- Flip reverse for quickly and easily changing between tightening and loosening
- Designed and manufactured to DIN3122D

Item ID: **RHA14**



7 Pieces 3/8"

**1/4" BIT SET WITH 3/8" COUPLER TX 7 PIECES**

- 3/8" drive bit holder/coupler
- 6 TX bits held in a "bullet holder" to avoid losing the bits

3/8" Drive x 1/4" Hex coupler
1/4" Hex Bits:
 Length 25mm TX10, TX15, TX20, TX25, TX30, TX40

Item ID: **1486**



4 Pieces 1/2"

**5/16" BIT SET WITH 1/2" COUPLER TX 4 PIECES**

- 1/2" drive bit holder/coupler
- 3 TX bits held in a "bullet holder" to avoid losing the bits

1/2" Drive x 5/16" Hex coupler
5/16" Hex Bits:
 Length 25mm TX45, TX50, TX55

Item ID: **1488**



10 Pieces 1/4"

**1/4" BIT SET WITH 1/4" COUPLER IPR 10 PIECES**

- For use with 5-wing fastenings with a tamper proof hole
- 1/4" drive bit holder/coupler
- Bits held in a "bullet holder" to avoid losing the bits

1/4" Drive x 1/4" Hex coupler
1/4" Hex Bits:
 Length 25mm IPR10, IPR15, IPR20, IPR25, IPR27, IPR30, IPR40, IPR45, IPR50

Item ID: **M1410T5**

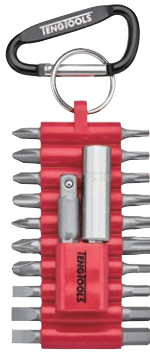
22  
Pieces**HOOK ON BIT SET MIXED 22 PIECES**

- Bit holder with a clip ring for use on a belt or with a safety wire if working at height
- Includes 20 assorted 25mm length bits together with a 60mm magnetic bit holder
- A 1/4" drive adaptor for use with 1/4" drive sockets and accessories

60mm magnetic bit holder, 1/4" Hex x 1/4" M adaptor

1/4" Hex Bits: Length 25mm	PZ1, PZ2, PZ3	PH1, PH2, PH3	PH2G
	TX10, TX15, TX20, TX25, TX30, TX40		
	3, 4, 5, 6	4.5, 5.5, 6.5 mm	

Item ID: **THBS22**22  
Pieces**HOOK ON IMPACT BIT SET MIXED 22 PIECES**

- A handy bit holder with a clip ring for use on a belt or safety wire if working at height
- Includes 20 assorted 30mm length impact bits together with a 60mm magnetic bit holder
- A 1/4" drive adaptor for use with 1/4" drive impact sockets
- Designed for higher torsion enabling use with power tools

60mm Impact magnetic bit holder, 1/4" Hex x 1/4" M adaptor

1/4" Hex Impact Bits: Length 30mm	PZ1, PZ2, PZ3	PH1, PH2, PH3	PH2G
	TX10, TX15, TX20, TX25, TX30, TX40		
	3, 4, 5, 6	1, 2, 3	

Item ID: **THBSI22**



28 Pieces

**BIT SET WITH BELT CLIP MIXED 28 PIECES**

- This set contains 26 of the most common 25mm bits together with a quick release bit holder and a 1/4" hex adaptor.
- Supplied in the unique TengTools TJ module
- Clear fold up lid to see which set you need to use
- Sliding catch to secure the set when not in use

50mm quick release bit holder, 1/4" Hex x 1/4" Square drive adaptor

1/4" Drive Hex Bits:

Length 25 mm:	4.5, 5.5, 6.5	4, 5, 6	1, 2, 3
	PH1, PH2, PH3	PZ1, PZ2, PZ3	PH2G (x2)
	TX10, TX15, TX20, TX25, TX30, TX40		
	TPX20, TPX25, TPX30		

Item ID: **TJ028**



29 Pieces

**BIT SET WITH BELT CLIP MIXED 29 PIECES**

- Bit set that fits into the TTTJ04 module allowing you to store 4 TJ sets in a single module
- 1/4" drive bits ratchet and magnetic bits holder
- A selection of 25mm bits

50mm quick release bit holder, 1/4" Hex x 1/4" Square drive adaptor

1/4" Drive Hex Bits:

Length 25 mm:	3.5, 5.5, 8	2, 3, 4, 5, 6, 8	1, 2, 3
	PH1, PH2, PH3	PZ1, PZ2, PZ3	
	TX10, TX15, TX20, TX25, TX30, TX40		
	TPX20, TPX25, TPX30		

Item ID: **TJ1429**



29 Pieces

**IMPACT BIT SET WITH BELT CLIP MIXED**

- Bit set that fits into the TTTJ04 module allowing you to store 4 TJ sets in a single module
- Impact magnetic bits holder and impact quick chuck
- A selection of 30mm impact bits

60mm magnetic impact bit holder, 60mm quick chuck impact bits holder

1/4" Drive Impact Hex Bits:

Length 30 mm:	PH1, PH2, PH3	PZ1, PZ2, PZ3	1, 2
	PH2G	3, 4 (x2), 5, 6	
	TX10, TX15, TX20 (x2), TX25 (x2), TX27, TX30 (x2)		

Item ID: **TJ1430**



12 Pieces

**IMPACT BIT SET CONSTRUCTION WITH BELT CLIP**

- Bit set that fits into the TTTJ04 module allowing you to store 4 TJ sets in a single module
- 60mm magnetic bits holder
- A selection of 30mm impact bits

60mm magnetic impact bit holder

1/4" Drive Impact Hex Bits:

Length 30 mm:	PH1, PH2, PH3	PH2G	1, 2
	TX10, TX20, TX25, TX30		

Item ID: **TJ1412**

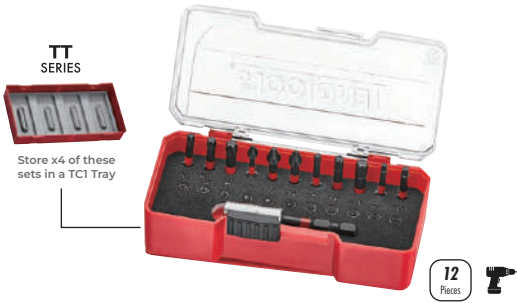

### IMPACT BIT SET WITH BELT CLIP MIXED

- Bit set that fits into the TTTJ04 module allowing you to store 4 TJ sets in a single module
- 60mm magnetic bits holder
- A selection of 30mm impact bits

60mm magnetic impact bit holder

1/4" Drive Impact Hex Bits:

Length 30 mm: 3, 4, 5 PH2G 1, 2  
 PZ1, PZ2 TX20, TX25, TX30

Item ID: **TJ1413**



### IMPACT BIT SET WITH BELT CLIP TX

- Bit set that fits into the TTTJ04 module allowing you to store 4 TJ sets in a single module
- 60mm magnetic bits holder
- A selection of 30mm impact TX bits

60mm magnetic impact bit holder

1/4" Drive Impact Hex Bits:

Length 30 mm TX10, TX15, TX20 (x3), TX25 (x2), TX27, TX30 (x2), TX40

Item ID: **TJ1414**



### IMPACT NUT SETTER SET WITH BELT CLIP

- Bit set that fits into the TTTJ04 module allowing you to store 4 TJ sets in a single module
- Includes a magnet for holding the fastening
- Suitable for use on ferrous fastenings

Impact Nut Setters:

Length 65 mm 1/4" 7, 8, 10, 13 mm

Item ID: **TJNS05**



### 1/4" SOCKET SET 6 PT 19 PIECES

- Regular 6 point single hexagon sockets for a better grip
- Chrome vanadium satin finish sockets
- A selection of screwdriver and hex bits
- Supplied in the unique TengTools case with a snap lock
- Hard wearing hinge with a metal pin for longer life
- Designed and manufactured to DIN and ISO standards

1/4" Mini bits ratchet

Magnetic bits holder, 1/4"M x 1/4" Hex adaptor

Regular 6 point sockets:

mm: 8 9 10 11 12 13  
 1/4" Hex bits: 4, 5, 5.5, 6.5 4, 5, 6  
 PH1, PH2 PZ1, PZ2

Item ID: **T1419**



20 Pieces 1/4"

**1/4" SOCKET SET 6 PT 20 PIECES**

- Regular 6 point single hexagon sockets for a better grip
- Chrome vanadium satin finish sockets
- A selection of screwdriver and TX bits
- Supplied in the unique TengTools case with a snap lock
- Hard wearing hinge with a metal pin for longer life
- Designed and manufactured to DIN and ISO standards

1/4" Mini bits ratchet	
Magnetic bits holder, 1/4"M x 1/4" Hex adaptor	
Regular 6 point sockets:	
mm:	5.5 6 7 8 9 10 13
1/4" Hex bits:	PH1, PH2 TX10, TX15, TX20 PZ1, PZ2

Item ID: **TI420**



29 Pieces

**BIT SET MIXED 29 PIECES**

- 25mm long screwdriver, hex and TX bits to suit different applications
- Reversible mini bits ratchet
- Supplied a bits box with a click lock lid and small enough to easily fit in the pocket

50mm magnetic bit holder, 1/4" Hex x 1/4"M adaptor, 1/4" bits ratchet with 8mm ring spanner on one end	
1/4" Drive Hex Bits:	
Length 25 mm:	4.5, 5.5, 6.5 4, 5, 6 1, 2, 3
	PH1, PH2, PH3 PZ1, PZ2, PZ3 PH2G (x2)
	TX10, TX15, TX20, TX25, TX30, TX40
	TPX20, TPX25, TPX30

Item ID: **TM029**



10 Pieces

**IMPACT BIT SET MIXED 10 PIECES**

- New design impact bits and adaptors for higher torsion
- Suitable for use with impact power tools
- Supplied in the unique TengTools bits box with a click lock lid
- Small enough to easily fit in the pocket

60mm magnetic impact bit holder	
1/4" Drive Impact Hex Bits:	
Length 30 mm:	4, 5 PH2G 1, 2
	PZ2 TX20, TX25, TX30

Item ID: **TM010**



10 Pieces

**IMPACT BIT SET TX 10 PIECES**

- New design impact bits and adaptors for higher torsion
- Suitable for use with impact power tools
- Supplied in the unique TengTools bits box with a click lock lid
- Small enough to easily fit in the pocket

60mm magnetic impact bit holder	
1/4" Drive Impact Hex Bits:	
Length 30 mm	TX10, TX15, TX20 (x2), TX25 (x2), TX27, TX30, TX40

Item ID: **TMTX10**







10 Pieces 

### IMPACT BIT SET CONSTRUCTION MIXED

- 10 piece 1/4" hex impact bit set
- All the most commonly used impact bits for the construction industry
- New design impact bits and adaptors for higher torsion
- Suitable for use with impact power tools
- Supplied in the unique TengTools bits box with a click lock lid
- Small enough to easily fit in the pocket

60mm magnetic impact bit holder

1/4" Drive Impact Hex Bits: 

Length 30 mm:	 PZ1, PZ2, PZ3	 PH2	 PH2G
	 TX10, TX20, TX25, TX30		

Item ID: **TMC010**











27 Pieces 

### IMPACT BIT SET MIXED 27 PIECES

- 27 piece impact bit set
- Designed for higher torsion
- Includes a comprehensive range of impact bits and accessories
- Supplied in the unique TengTools bits box
- A sliding lock system helps keep the contents secure

60mm Impact magnetic bit holder, 1/4" Hex x 1/4" M adaptor

1/4" Drive Impact nut setters - Length 65mm 

	Size: 1/4" 7 8 10
1/4" Hex	 PH1, PH2, PH3  3, 4, 5, 6
Impact Bits:	 PZ1, PZ2, PZ3  PH2G
Length 30mm	 TX10, TX15, TX20, TX25, TX40
Length 89mm	 TX25, TX30  1, 2, 3

Item ID: **TBBSI27**



5 Pieces 

### IMPACT NUT SETTER SET 5 PIECES

- Designed for higher torsion
- Includes a magnet for holding the fastening
- Suitable for use on ferrous fastenings
- Supplied in the unique TengTools storage case
- A sliding lock system helps keep the contents secure

1/4" Drive Impact nut setters - Length 65mm: 

 Size: 1/4", 7, 8, 10, 13 mm

Item ID: **TBNSI5**







### 1/4" STUBBY BITS DRIVER

- Stubby handle ideal for use in confined spaces
- For use with any 1/4" hex drive bits
- Magnetic bit holder that holds the bit in place

Item ID: **MDBH**



### 1/4" MAGNETIC BITS DRIVER 193MM

- For use with any 1/4" hex drive bits
- Magnetic bit holder that holds the bit in place
- Overall length 193mm

Item ID: **MD193**



### 1/4" MAGNETIC BITS DRIVER 217MM

- For use with any 1/4" hex drive bits
- Magnetic bit holder that holds the bit in place
- Hex shape shaft for use with a wrench for extra torque
- Overall length 217mm

Item ID: **MD216**



### 1/4" LONG FLEXIBLE BITS DRIVER

- For use with any 1/4" hex drive bits
- Magnetic bit holder that holds the bit in place
- Flexible spring wound shaft for easier access in confined spaces
- Protected with a plastic sleeve that allows the driver to turn even when the shaft is gripped
- Overall length 555mm

Item ID: **MD907FL**



### 1/4" T HANDLE QUICK CHUCK BITS DRIVER

- T drive facility for extra torque
- For use with any 1/4" hex drive bits
- Quick chuck bit holder on the long end (overall length 130mm)
- Magnetic bit holder on the short end (overall length 75mm)

Item ID: **MDTHQ**



### 1/4" QUICK CHUCK BITS DRIVER 147MM

- For use with any 1/4" hex drive bits
- Quick chuck bit holder that holds the bit in place
- Overall length 147mm

Item ID: **MDQ147**



### 1/4" QUICK CHUCK BITS DRIVER 183MM

- For use with any 1/4" hex drive bits
- Quick chuck bit holder that holds the bit in place
- Overall length 183mm

Item ID: **MDQ183**



**1/4" QUICK CHUCK BITS DRIVER 217MM**

- For use with any 1/4" hex drive bits
- Quick chuck bit holder that holds the bit in place
- Hex shape shaft for use with a wrench for extra torque
- Overall length 217mm

Item ID: **MDQ217**



**9**  
Pieces

**1/4" STUBBY BITS DRIVER SET 9 PIECES**

- Stubby handle ideal for use in confined spaces
- Includes 8 of the most commonly used bits in a bullet style holder
- Magnetic bit holder that holds the bit in place

1/4" Hex Drive Bits:

Length	⊖	6.5, 8 mm
25mm	⊕	PH1, PH2
	⊕	PZ1, PZ2
	⊕	4, 5 mm

Item ID: **MD908N**



**8**  
Pieces

**1/4" STUBBY RATCHETING BITS DRIVER SET**

- Stubby handle ideal for use in confined spaces
- Forward, reverse and fixed settings
- 20 teeth ratchet mechanism for 18° increments between each click
- Includes 6 bits plus a 1/4" drive socket adaptor
- Bit storage inside the handle to avoid losing bits
- Magnetic bit holder that holds the bit in place

1/4" Hex x 1/4"M adaptor

1/4" Hex Drive Bits:

Length	⊖	5, 7 mm
25mm	⊕	PH1, PH2
	⊕	PZ1, PZ2

Item ID: **MDR908S**



**8**  
Pieces

**1/4" RATCHETING BITS DRIVER SET 8 PIECES**

- Forward, reverse and fixed settings
- 20 teeth ratchet mechanism for 18° increments between each click
- Includes 6 bits plus a 1/4" drive socket adaptor
- Bit storage inside the handle to avoid losing bits
- Magnetic bit holder that holds the bit in place

1/4" Hex x 1/4"M adaptor

1/4" Hex Drive Bits:

Length	⊖	5, 7 mm
25mm	⊕	PH1, PH2
	⊕	PZ1, PZ2

Item ID: **MDR908**



**8**  
Pieces

**1/4" RATCHETING BITS DRIVER DOUBLE END BITS SET 8 PIECES**

- Forward, reverse and fixed settings
- 20 teeth ratchet mechanism for 18° increments between each click
- 14 different screwdrivers in one
- Bit storage inside the handle to avoid losing bits
- Magnetic bit holder that holds the bit in place

1/4" Hex Drive Bits:

Length	⊖	4 x 6 mm
25mm	⊕	PH0 x PH3, PH1 x PH2
	⊕	PZ0 x PZ3, PZ1 x PZ2
	⊕	TX10 x TX15, TX20 x TX25

Item ID: **MDR915**





8 Pieces

**1/4" RATCHETING ANGLED BITS DRIVER SET**

- Can be used straight or offset at up to 60° to create a pistol grip for added torque
- Forward, reverse and fixed settings
- 20 teeth ratchet mechanism for 18° increments between each click
- Includes 6 bits plus a 1/4" drive socket adaptor
- Bit storage inside the handle to avoid losing bits
- Quick chuck bit holder that holds the bit in place

1/4" Hex x 1/4"M adaptor

1/4" Hex Drive Bits:

Length 25mm	⊖	5, 7 mm
	⊕	PH1, PH2
	⊕*	PZ1, PZ2

Item ID: **MDRT908**



8 Pieces

**1/4" RATCHETING QUICK CHUCK BITS DRIVER**

- Forward, reverse and fixed settings
- 20 teeth ratchet mechanism for 18° increments
- Includes 6 bits plus a 1/4" drive socket adaptor
- Bit storage inside the handle to avoid losing bits
- Quick chuck bit holder that holds the bit in place

1/4" Hex x 1/4"M adaptor

1/4" Hex Drive Bits:

Length 25mm	⊖	5, 7 mm
	⊕	PH1, PH2
	⊕*	PZ1, PZ2

Item ID: **MDRQ908**



6 Pieces

1/2"

**1/2" & 5/16" IMPACT DRIVER SET 6 PIECES**

- Reversible action impact driver for shifting stubborn fastenings
- 1/2" drive square drive for use with impact sockets and accessories
- Removable bit holder included for use with 5/16" hexagon drive impact bits
- Set includes four impact bits covering the most popular screw head sizes and types
- Supplied in a handy storage case

Reversible impact driver, coupler adaptor

5/16" Hex bits: ⊖ 8, 10 ⊕ PH2, PH3  
Length 36mm

Item ID: **ID506**



4 Pieces

**5/16" IMPACT BIT SET MIXED 4 PIECES**

- Spare bits for the ID506 impact driver

5/16" Hex bits: ⊖ 8, 10 ⊕ PH2, PH3  
Length 36mm

Item ID: **ID506BIT**



13 Pieces

**5/16" IMPACT BIT SET MIXED 13 PIECES**

- Spare bits for the ID515 impact driver

5/16" Hex x 3/8"M adaptor

5/16" Hex bits: ⊖ 6, 8, 10, 12 ⊕ PH1, PH2, PH3, PH4  
Length 36mm ⊖ 4, 5, 6 8

Item ID: **ID515BIT**



15 Pieces 1/2"

### 1/2" & 5/16" IMPACT DRIVER SET 15 PIECES

- Reversible action heavy duty impact driver for shifting stubborn fastenings
- 1/2" drive square drive for use with impact sockets and accessories
- Removable bit holder included for use with 5/16" hexagon drive impact bits
- Set includes 12 impact bits covering the most popular screw head sizes and types
- Supplied in a handy storage case

Heavy duty reversible impact driver, coupler adaptor, 5/16" Hex x 3/8"M adaptor

5/16" Hex bits: 6, 8, 10, 12 PH1, PH2, PH3, PH4  
 Length 36mm 4, 5, 6 8

Item ID: **ID515**



7 Pieces 1/4"

### 1/4" IMPACT DRIVER SET 7 PIECES

- For use with 1/4" hexagon drive impact bits
- Supplied complete with the most popular screwdriver head sizes and types
- Screw extractor bits also included for removing damaged fastenings
- Bits are held in a handy "bullet holder" for safe storage

1/4" Drive reversible impact driver

Screw Extractors: 1 2 3

1/4" Hex Impact Bits: PH1, PH2 5mm

Item ID: **IDSE7**



### 5/16" HEX IMPACT BITS

- 5/16" hexagon drive impact bits
- For use with 1/2" drive impact drivers
- Designed for use with fastenings with a hexagon hole
- Use with in-hex screws or grub screws

ITEM ID:	Drive	Description	Length mm
910504	5/16" hex	4mm hex impact bit	36
910505	5/16" hex	5mm hex impact bit	36
910506	5/16" hex	6mm hex impact bit	36
910508	5/16" hex	8mm hex impact bit	36
910510	5/16" hex	10mm hex impact bit	36
920001	5/16" hex	PZ1 impact bit	36
920002	5/16" hex	PZ2 impact bit	36
920003	5/16" hex	PZ3 impact bit	36
940006	5/16" hex	6mm flat impact bit	36
940008	5/16" hex	8mm flat impact bit	36
940010	5/16" hex	10mm flat impact bit	36
940012	5/16" hex	12mm flat impact bit	36
930001	5/16" hex	PH1 impact bit	36
930002	5/16" hex	PH2 impact bit	36
930003	5/16" hex	PH3 impact bit	36
930004	5/16" hex	PH4 impact bit	36
970030	5/16" hex	TX30 impact bit	36
970040	5/16" hex	TX40 impact bit	36
970045	5/16" hex	TX45 impact bit	36
970050	5/16" hex	TX50 impact bit	36
970055	5/16" hex	TX55 impact bit	36



# HEX & TX KEYS

## Versatile, strong and durable

TengTools wide range of hex & TX keys consists of a range of keys made of chrome vanadium steel for industrial use and a series made of chrome-molybdenum for heavy duty usage.



### CHROME VANADIUM STEEL

Stronger, harder and more durable than regular carbon steels. This guarantees the high level of quality that you would expect from a TengTools item

Our cases are designed to hold the wrenches tight enough so they didn't fall out but with a flexible enough grip that they were are still easily removed

For higher torque applications it is better to use the straight end Hex keys for maximum fastener engagement

Available in metric & imperial sizes up to 19mm or 1/2"

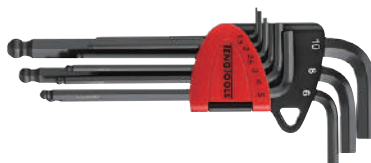

### CHROME MOLYBDENUM STEEL

It is an alloy tool steel with chromium (Cr), molybdenum (Mo), iron (Fe) and carbon (C) alloy elements. The highest quality steel that we use. It is particularly hard and strong, but also has an amount of flex. Ideal to use when more torque is required.

Ballpoint heads are ideal for areas that are hard to reach. Fastenings can be turned at an angle of 25° in a Hex or TX key.



Get Organised™





**HEX KEY METRIC**

- Metric hexagon key wrench
- Individually marked for size
- Ground key ends for a better finish and accurate fit
- Manufactured in chrome vanadium steel with a black phosphate finish
- Designed and manufactured to DIN 2936

ITEM ID:	Size mm	Short Arm Length mm	Long Arm Length mm
3105007	0.7	8	35
3105009	0.9	10	38
3105013	1.3	12	41
3105015	1.5	14	45
310502	2	16	50
3105025	2.5	18	56
310503	3	20	63
310504	4	25	70
3105045	4.5	26	75
310505	5	28	80
3105055	5.5	30	85
310506	6	32	90
310507	7	34	95
310508	8	36	100
310509	9	38	106
310510	10	40	112
310511	11	42	118
310512	12	45	125
310514	14	56	140
310516	16	60	152
310517	17	63	160
310518	18	66	159
310519	19	70	180
310522	22	80	200
310527	27	100	250
310532	32	125	315
310536	36	140	355



**HEX KEY AF**

- Individually marked for size
- Ground key ends for a better finish and accurate fit
- Manufactured in chrome vanadium steel with a black phosphate finish
- Designed and manufactured to ASME B18.3

ITEM ID:	Size AF	Short Arm Length mm	Long Arm Length mm
310102	1/16"	14	44
3101025	5/64"	15	48
310103	3/32"	17	51
3101035	7/64"	18	54
310104	1/8"	19	57
3101045	9/64"	20	60
310105	5/32"	21	64
310106	3/16"	24	70
310107	7/32"	26	76
310108	1/4"	28	83
310110	5/16"	32	95
310112	3/8"	35	108
310114	7/16"	38	121
310116	1/2"	41	133
310120	5/8"	48	159





### EXTRA LONG HEX KEY METRIC

- Extra long metric hexagon key wrench
- Individually marked for size
- Manufactured in chrome vanadium steel with a black phosphate finish

ITEM ID:	Size mm	Short Arm Length mm	Long Arm Length mm
3205015	1.5	14	90
320502	2	16	100
3205025	2.5	18	112
320503	3	20	126
320504	4	25	140
320505	5	28	160
320506	6	32	180
320508	8	36	200
320510	10	40	224



### BALL POINT HEX KEY METRIC

- Ball point end on the long key end giving access at angles of up to 25°
- Ideal for use in confined spaces
- Regular hex end on the short arm giving the ability to apply higher torque
- Manufactured in chrome vanadium steel with a black phosphate finish
- Individually marked for size for easier identification

ITEM ID:	Size mm	Short Arm Length mm	Long Arm Length mm
3105015BL-C	1.5	14	77
310502BL-C	2	16	83
3105025BL-C	2.5	18	90
310503BL-C	3	20	98
310504BL-C	4	25	106
310505BL-C	5	28	118
310506BL-C	6	32	137
310507BL-C	7	34	147
310508BL-C	8	36	156
310510BL-C	10	40	170
310512BL-C	12	45	207
310514BL-C	14	56	230
310517BL-C	17	63	250
310519BL-C	19	70	280

**NEW**



### EXTRA LONG BALL POINT HEX KEYS

- Manufactured in Chrome molybdenum steel for added strength
- Ball point end on the long key end giving access at angles of up to 25°
- Ideal for use in confined spaces
- Regular hex end on the short arm giving the ability to apply higher torque
- Individually marked for size for easier identification

ITEM ID:	Size mm	Short Arm Length mm	Long Arm Length mm
3908015BL	1.5	14	90
3908020BL	2	16	100
3908025BL	2.5	18	112
390803BL	3	20	126
390804BL	4	25	140
390805BL	5	28	160
390806BL	6	32	180
390808BL	8	36	200
390810BL	10	40	224







**BALL POINT HEX KEY CR-MO METRIC**

- Manufactured in Chrome molybdenum steel for added strength
- Ball point end on the long key end giving access at angles of up to 25°
- Ideal for use in confined spaces
- Regular hex end on the short arm giving the ability to apply higher torque
- Individually marked for size for easier identification

ITEM ID:	Size mm	Short Arm Length mm	Long Arm Length mm
3905015BL	1.5	14	77
390502BL	2	16	83
3905025BL	2.5	18	90
390503BL	3	20	98
390504BL	4	25	106
390505BL	5	28	118
390506BL	6	32	137
390508BL	8	36	156
390510BL	10	40	170



**BALL POINT HEX KEY CR-MO AF**

- Manufactured in Chrome molybdenum steel for added strength
- Ball point end on the long key end giving access at angles of up to 25°
- Ideal for use in confined spaces
- Regular hex end on the short arm giving the ability to apply higher torque
- Individually marked for size for easier identification of the right size wrench

ITEM ID:	Size AF	Short Arm Length mm	Long Arm Length mm
3901025BL	5/64"	15	82
390103BL	3/32"	17	88
390104BL	1/8"	19	96
390105BL	5/32"	21	105
390106BL	3/16"	24	114
390107BL	7/32"	26	124
390108BL	1/4"	28	135
390110BL	5/16"	32	151
390112BL	3/8"	35	170

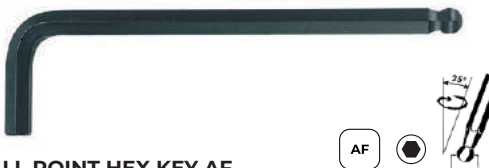

**BALL POINT HEX KEY AF**

- Ball point end on the long key end giving access at angles of up to 25°
- Ideal for use in confined spaces
- Regular hex end on the short arm giving the ability to apply higher torque
- Manufactured in chrome vanadium steel with a black phosphate finish

ITEM ID:	Size AF	Short Arm Length mm	Long Arm Length mm
3101025BL	5/64"	15	82
310103BL	3/32"	17	88
310104BL	1/8"	19	96
310105BL	5/32"	21	105
310106BL	3/16"	24	114
310107BL	7/32"	26	124
310108BL	1/4"	28	135
310110BL	5/16"	32	151
310112BL	3/8"	35	170

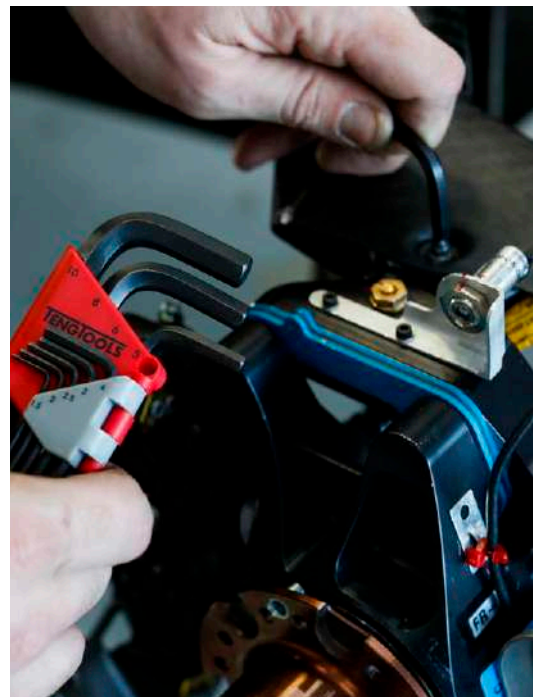



**T HANDLE BALL POINT HEX KEY METRIC**

- Ball point end on the long key end giving access at angles of up to 25°
- Ideal for use in confined spaces
- Regular hex end on the short arm giving the ability to apply higher torque
- Manufactured in chrome molybdenum for extra strength
- Ergonomically designed bi-material handle for easy use with higher torque
- Hole in the handle for hanging or for use with a fall protection wire

ITEM ID:	Size mm	Short Arm Length mm	Long Arm Length mm
510502	2	12	100
5105025	2.5	12	100
510503	3	12	100
510504	4	12	100
510505	5	15	150
510506	6	15	150
510507	7	15	150
510508	8	18	190
510510	10	20	200
510512	12	20	200



**T HANDLE HEX KEY METRIC**

- Regular hex end on both arms giving the ability to apply higher torque
- Larger contact zone with the fastening reduces wear inside hexagon socket screws
- Manufactured in chrome molybdenum for extra strength
- Ergonomically designed bi-material handle for easy use with higher torque
- Hole in the handle for hanging or for use with a fall protection wire

ITEM ID:	Size mm	Short Arm Length mm	Long Arm Length mm
5106025	2.5	15	100
510603	3	15	100
510604	4	15	100
510605	5	18	150
510606	6	18	150
510607	7	18	150
510608	8	18	190



**TT**  
SERIES Hex & TX Key Sets available

**MODULAR TOOL CONTROL SYSTEM**



**PAGE 80**

**FOAM**  
SERIES Hex & TX Key Sets available

**MODULAR TOOL CONTROL SYSTEM**

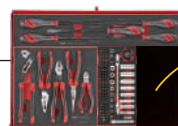

**PAGE 141**



**T HANDLE BALL POINT HEX KEY AF**

- Ball point end on the long key end giving access at angles of up to 25°
- Ideal for use in confined spaces
- Regular hex end on the short arm giving the ability to apply higher torque
- Manufactured in chrome molybdenum for extra strength
- Ergonomically designed bi-material handle for easy use with higher torque
- Hole in the handle for hanging or for use with a fall protection wire

ITEM ID:	Size AF	Short Arm Length mm	Long Arm Length mm
510103	3/32"	12	100
510104	1/8"	12	100
510105	5/32"	12	100
510106	3/16"	12	100
510107	7/32"	15	150
510108	1/4"	15	150
510110	5/16"	15	150

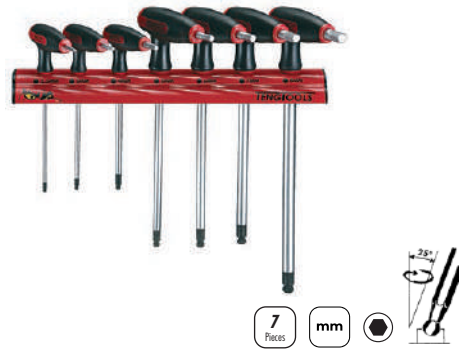

**T-HANDLE BALL POINT HEX KEY WALL RACK**

- Ball point end on the long key end giving access at angles of up to 25°
- Regular hex end on the short arm to apply higher torque to stubborn fastenings
- Supplied with a wall rack for fixing to the wall or a workbench

Ball Point T-Handle Hex Drivers:

	100 mm long:	2.5, 3, 4 mm
	150 mm long:	5, 6, 7 mm
	190 mm long:	8 mm

Item ID: **WRHEX07**



**T-HANDLE BALL POINT HEX KEY AF WALL RACK**

- Ball point end on the long key end giving access at angles of up to 25°
- Regular hex end on the short arm to apply higher torque to stubborn fastenings
- Supplied with a wall rack for fixing to the wall or a workbench
- Template and fixings included

Ball Point T-Handle Hex Drivers:

	100 mm long:	3/32", 1/8", 5/32"
	150 mm long:	3/16", 7/32", 1/4"
	190 mm long:	5/16"

Item ID: **WRHEX07AF**

**HEX KEY SET 9 PIECES**

- Regular hex end on both arms giving the ability to apply higher torque
- Chrome vanadium steel with a black finish
- Each key can be easily removed or used by simply twisting in it's individual holder
- Supplied with a folding plastic holder to keep the keys together

Hex Keys with Folding Plastic Holder:

 1.5, 2, 2.5, 3, 4, 5, 6, 8, 10 mm
Item ID: **1479MMR****EXTRA LONG HEX KEY SET 9 PIECES**

- Regular hex end on both arms giving the ability to apply higher torque
- Chrome vanadium steel with a black finish
- Each key can be easily removed or used by simply twisting in it's individual holder
- Supplied with a folding plastic holder to keep the keys together

Hex Keys with Folding Plastic Holder:

 1.5, 2, 2.5, 3, 4, 5, 6, 8, 10 mm
Item ID: **1479MMRL****BALL POINT HEX KEY SET 7 PIECES**

- Ball point end on the long key end giving access at angles of up to 25°
- Ideal for use in confined spaces
- Regular hex end on the short arm giving the ability to apply higher torque
- Chrome vanadium steel with a black finish
- Each key can be easily removed or used by simply twisting in it's individual holder
- Supplied with a plastic holder to keep the keys together

Hex Keys with Folding Plastic Holder:

 2.5, 3, 4, 5, 6, 8, 10 mm
Item ID: **1475****BALL POINT HEX KEY SET 9 PIECES**

- Ball point end on the long key end giving access at angles of up to 25°
- Ideal for use in confined spaces
- Regular hex end on the short arm giving the ability to apply higher torque
- Chrome vanadium steel with a black finish
- Each key can be easily removed or used by simply twisting in it's individual holder
- Supplied with a folding plastic holder to keep the keys together

Hex Keys with Folding Plastic Holder:

 1.5, 2, 2.5, 3, 4, 5, 6, 8, 10 mm
Item ID: **1479MM**



**BALL POINT HEX KEY SET A 9 PIECES**

- Includes 7mm, commonly used in automotive applications
- Ball point end on the long key end giving access at angles of up to 25°
- Ideal for use in confined spaces
- Regular hex end on the short arm giving the ability to apply higher torque
- Chrome vanadium steel with a black finish
- Each key can be easily removed or used by simply twisting in it's individual holder
- Supplied with a folding plastic holder to keep the keys together

Hex Keys with Folding Plastic Holder:

- 1.5, 2, 2.5, 3, 4, 5, 6, 7, 10 mm

Item ID: **1479MMA**

**NEW**



**EXTRA LONG BALL POINT HEX KEY SET 9 PIECES**

- Chrome molybdenum steel for extra strength
- Ball point end on the long key end giving access at angles of up to 25°
- Ideal for use in confined spaces
- Regular hex end on the short arm giving the ability to apply higher torque
- Each key can be easily removed or used by simply twisting in it's individual holder
- Supplied with a folding plastic holder to keep the keys together

Hex Keys with Folding Plastic Holder:

- 1.5, 2, 2.5, 3, 4, 5, 6, 8, 10 mm

Item ID: **1499MML**



**BALL POINT HEX KEY SET CR-MO 9 PIECES**

- Chrome molybdenum steel for extra strength
- Ball point end on the long key end giving access at angles of up to 25°
- Ideal for use in confined spaces
- Regular hex end on the short arm giving the ability to apply higher torque
- Each key can be easily removed or used by simply twisting in it's individual holder
- Supplied with a folding plastic holder to keep the keys together

Hex Keys with Folding Plastic Holder:

- 1.5, 2, 2.5, 3, 4, 5, 6, 7, 10 mm

Item ID: **1499MM**



**TT**  
SERIES Hex & TX Key Sets available

**MODULAR TOOL CONTROL SYSTEM**



**PAGE 80**

**FOAM**  
SERIES Hex & TX Key Sets available

**MODULAR TOOL CONTROL SYSTEM**



**PAGE 141**

**BALL POINT HEX KEY SET AF 7 PIECES**

- Ball point end on the long key end giving access at angles of up to 25°
- Ideal for use in confined spaces
- Regular hex end on the short arm giving the ability to apply higher torque
- Chrome vanadium steel with a black finish
- Each key can be easily removed or used by simply twisting in it's individual holder
- Supplied with a plastic holder to keep the keys together

Hex Keys with Folding Plastic Holder:

1/8", 5/32", 3/16", 7/32", 1/4", 5/16", 3/8"

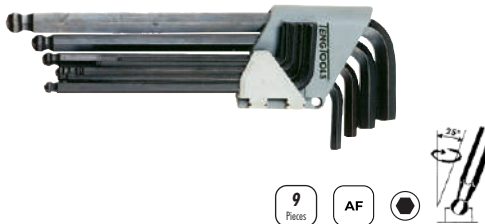
Item ID: **1474****BALL POINT HEX KEY SET AF 9 PIECES**

- Ball point end on the long key end giving access at angles of up to 25°
- Ideal for use in confined spaces
- Regular hex end on the short arm giving the ability to apply higher torque
- Chrome vanadium steel with a black finish
- Each key can be easily removed or used by simply twisting in it's individual holder
- Supplied with a folding plastic holder to keep the keys together

Hex Keys with Folding Plastic Holder:

5/64", 3/32", 1/8", 5/32", 3/16", 7/32", 1/4", 5/16", 3/8"

Item ID: **1479AF****BALL POINT HEX KEY SET CR-MO AF 9 PIECES**

- Chrome molybdenum steel for extra strength
- Ball point end on the long key end giving access at angles of up to 25°
- Ideal for use in confined spaces
- Regular hex end on the short arm giving the ability to apply higher torque
- Each key can be easily removed or used by simply twisting in it's individual holder
- Supplied with a folding plastic holder to keep the keys together

Hex Keys with Folding Plastic Holder:

5/64", 3/32", 1/8", 5/32", 3/16", 7/32", 1/4", 5/16", 3/8"

Item ID: **1499AF****FOLDING HEX KEY SET 1.5-6 MM ALU 7 PIECES**

- Chrome vanadium steel with a black finish
- Retractable keys held in a fold up aluminium holder
- Designed and manufactured to DIN2936

Hex Keys with Aluminium Holder:

1.5, 2, 2.5, 3, 4, 5, 6 mm

Item ID: **1476NMM**



**FOLDING HEX KEY SET 2.5-10 MM ALU 7 PIECES**

- Chrome vanadium steel with a black finish
- Retractable keys held in a fold up aluminium holder
- Designed and manufactured to DIN2936

Hex Keys with Aluminium Holder:

● 2.5, 3, 4, 5, 6, 8, 10 mm

Item ID: **1476NMM1**



**FOLDING HEX KEY SET 1.5-6 MM 7 PIECES**

- Chrome vanadium steel with a black finish
- Retractable keys held in a fold up chromed holder
- Features a fold out ring connector for use with a safety wire for added security when working at heights

Hex Keys with Chromed Holder:

● 1.5, 2, 2.5, 3, 4, 5, 6 mm

Item ID: **1471MM**



**FOLDING HEX KEY SET AF ALU 7 PIECES**

- Chrome vanadium steel with a black finish
- Retractable keys held in a fold up aluminium holder
- Designed and manufactured to ASME B18.3

Hex Keys with Aluminium Holder:

● 1/16", 5/64", 3/32", 1/8", 5/32", 3/16", 7/32"

Item ID: **1476NAF**



**FOLDING HEX KEY SET 2.5-10 MM 7 PIECES**

- Chrome vanadium steel with a black finish
- Retractable keys held in a fold up chromed holder
- Features a fold out ring connector for use with a safety wire for added security when working at heights

Hex Keys with Chromed Holder:

● 1.5, 2, 2.5, 3, 4, 5, 6 mm

Item ID: **1471MMA**

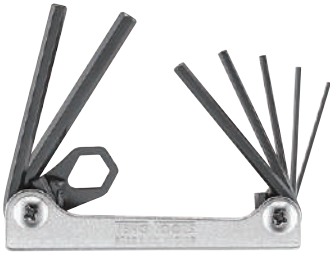

7 Pieces AF

### FOLDING HEX KEY SET AF 7 PIECES

- Chrome vanadium steel with a black finish
- Retractable keys held in a fold up chromed holder
- Features a fold out ring connector for use with a safety wire for added security when working at heights

Hex Keys with Chromed Holder:

1/16", 5/64", 3/32", 1/8", 5/32", 3/16", 7/32"

Item ID: **1471AF**



6 Pieces AF

### FOLDING HEX KEY SET AF 6 PIECES

- Chrome vanadium steel with a black finish
- Retractable keys held in a fold up chromed holder
- Features a fold out ring connector for use with a safety wire for added security when working at heights

Hex Keys with Chromed Holder:

1/8", 5/32", 3/16", 1/4", 5/16", 3/8"

Item ID: **1471AFA**



10 Pieces mm

### HEX KEY SET 10 PIECES

- Chrome vanadium steel with a black finish
- Each key can be removed by simply unscrewing from it's individual holder
- Supplied on a ring to keep the keys together

Hex Keys with Ring Holder:

1.5, 2, 2.5, 3, 4, 5, 6, 7, 8, 10 mm

Item ID: **1425**



10 Pieces AF

### HEX KEY SET AF 10 PIECES

- Chrome vanadium steel with a black finish
- Each key can be removed by simply unscrewing from it's individual holder
- Supplied on a ring to keep the keys together

Hex Keys with Ring Holder:

1/16", 5/64", 3/32", 1/8", 5/32", 3/16", 7/32", 1/4", 5/16", 3/8"

Item ID: **1424**





**TX KEY**

- Manufactured in chrome vanadium steel with a black phosphate finish

ITEM ID:	Size TX	For Screws M	Length mm
320008	8	2.5	16x80
320009	9	3	16x83
320010	10	3.0-3.5	17x86
320015	15	3.5-4.0	18x90
320020	20	4.0-5.0	19x95
320025	25	4.5-5.0	20x100
320027	27	4.5-6.0	22x105
320030	30	6.0-7.0	24x114
320040	40	7.0-8.0	26x124
320045	45	8.0-10.0	29x133
320050	50	10	32x152



**BALL POINT TX KEY**

- Ball point end on the long key end giving access at angles up to 25°
- Ideal for use in confined spaces
- Regular TX end on the short arm giving the ability to apply higher torque
- Manufactured in chrome vanadium steel with a black phosphate finish

ITEM ID:	Size TX	For Screws M	Length mm
320008BL	8	2.5	16x80
320009BL	9	3	16x83
320010BL	10	3.0-3.5	17x86
320015BL	15	3.5-4.0	18x90
320020BL	20	4.0-5.0	19x95
320025BL	25	4.5-5.0	20x100
320027BL	27	4.5-6.0	22x105
320030BL	30	6.0-7.0	24x114
320040BL	40	7.0-8.0	26x124
320045BL	45	8.0-10.0	29x133
320050BL	50	10	32x152



TengTools ambassador  
**Vanessa Ruck**



**BALL POINT TX KEY CR-MO**

- Manufactured in chrome molybdenum steel for added strength
- Ball point end on the long key end giving access at angles up to 25°
- Ideal for use in confined spaces
- Regular hex end on the short arm giving the ability to apply higher torque
- Individually marked for size for easier identification of the right size wrench

ITEM ID:	Size TX	Short Arm Length mm	Long Arm Length mm
390908BL	8	16	80
390909BL	9	16	83
390910BL	10	17	86
390915BL	15	18	90
390920BL	20	19	95
390925BL	25	20	100
390927BL	27	22	105
390930BL	30	24	114
390940BL	40	26	124



**T HANDLE BALL POINT TX KEY**

- TPX type on the long key end for tamper proof TX fastenings
- Regular TX end on the short arm giving the ability to apply higher torque
- Manufactured in chrome molybdenum for extra strength
- Ergonomically designed bi-material handle for use with higher torque
- Hole in the handle for hanging or for use with a fall protection wire

ITEM ID:	Size TX	Short Arm Length mm	Long Arm Length mm
520009	TX/TPX9	12	100
520010	TX/TPX10	12	100
520015	TX/TPX15	12	100
520020	TX/TPX20	12	100
520025	TX/TPX25	15	150
520027	TX/TPX27	15	150
520030	TX/TPX30	15	150
520040	TX/TPX40	18	190
520045	TX/TPX45	20	200
520050	TX/TPX50	20	200
520055	TX/TPX55	20	200



**TT**  
SERIES Hex & TX Key Sets available

**MODULAR TOOL CONTROL SYSTEM**



**PAGE 80**

**FOAM**  
SERIES Hex & TX Key Sets available

**MODULAR TOOL CONTROL SYSTEM**



**PAGE 141**





**TX KEY SET 9 PIECES**

- Chrome vanadium steel with a black finish
- Each key can be easily removed or used by simply twisting in it's individual holder
- Supplied with a folding plastic holder to keep the keys together

TX Keys with folding plastic holder:

- ★ TX8, TX9, TX10, TX15, TX20, TX25, TX27, TX30, TX40

Item ID: **1479TX**



**BALL POINT TX KEY SET 9 PIECES**

- Ball point end on the long key end giving access at angles up to 25°
- Ideal for use in confined spaces
- Regular end on the short arm giving the ability to apply higher torque
- Chrome vanadium steel with a black finish
- Each key can be easily removed or used by simply twisting in it's individual holder
- Supplied with a folding plastic holder to keep the keys together

TX Keys with folding plastic holder:

- ★ TX8, TX9, TX10, TX15, TX20, TX25, TX27, TX30, TX40

Item ID: **1479TX1**



**BALL POINT TX KEY SET CR-MO 9 PIECES**

- Chrome molybdenum steel for added strength
- Ball point end on the long key end giving access at angles up to 25°
- Ideal for use in confined spaces
- Regular end on the short arm giving the ability to apply higher torque
- Each key can be easily removed or used by simply twisting in it's individual holder
- Supplied with a folding plastic holder to keep the keys together

TX Keys with folding plastic holder:

- ★ TX8, TX9, TX10, TX15, TX20, TX25, TX27, TX30, TX40

Item ID: **1499TX**



**FOLDING TX KEY SET 8 PIECES**

- Chrome vanadium steel with a black finish
- Retractable keys held in a fold up aluminium holder

TX Keys with Aluminium Holder:

- ★ TX9, TX10, TX15, TX20, TX25, TX27, TX30, TX40

Item ID: **1476NTX**





**FOLDING BALL POINT TX KEY SET 8 PIECES**

- Ball point end giving access at angles of up to 25°, ideal for use in confined spaces
- Chrome vanadium steel with a black finish
- Retractable keys held in a fold up aluminium holder

TX Keys with Aluminium Holder:

- TX9, TX10, TX15, TX20, TX25, TX27, TX30, TX40

Item ID: **1476NTX1**



**FOLDING TX KEY SET CR-MO 8 PIECES**

- Chrome molybdenum steel for added strength
- Retractable keys held in a fold up chromed holder
- Features a fold out ring connector for use with a safety wire for added security when working at heights

TX Keys with Chromed Holder:

- TX9, TX10, TX15, TX20, TX25, TX27, TX30, TX40

Item ID: **1476NTX2**



**TX KEY SET 7 PIECES**

- Chrome vanadium steel with a matt finish
- Each key can be removed by simply unscrewing from it's individual holder
- Supplied on a ring to keep the keys together

TX Keys with Ring Holder:

- TX10, TX15, TX20, TX25, TX27, TX30, TX40

Item ID: **1487**



**T-HANDLE TX/TPX KEY WALL RACK**

- TPX type on the long key end for tamper proof TX fastenings
- Regular TX end on the short arm to apply higher torque to stubborn fastenings
- Supplied with a wall rack for fixing to the wall or a workbench

T-Handle TX Drivers:

- 100 mm long: TX/TPX10, TX/TPX15, TX/TPX20
- 150 mm long: TX/TPX25, TX/TPX27, TX/TPX30
- 190 mm long: TX/TPX40

Item ID: **WRTX07**



**TPX KEY CR-MO**

- TPX type on both end for tamper proof TX fastenings
- Manufactured in chrome molybdenum steel for added strength
- Individually marked for size

ITEM ID:	Size TX	Short Arm Length mm	Long Arm Length mm
390808TPX	TPX8	16	80
390809TPX	TPX9	16	83
390810TPX	TPX10	17	86
390815TPX	TPX15	18	90
390820TPX	TPX20	19	95
390825TPX	TPX25	20	100
390827TPX	TPX27	22	105
390830TPX	TPX30	24	114
390840TPX	TPX40	26	124



**9 PIECE TPX KEY SET 9 PIECES**

- Chrome molybdenum steel for added strength
- TPX type on both end for tamper proof TX fastenings
- Each key can be easily removed or used by simply twisting in it's individual holder
- Supplied with a folding plastic holder to keep the keys together

TPX Keys with folding plastic holder:

-  TX8, TX9, TX10, TX15, TX20, TX25, TX27, TX30, TX40

Item ID: **1498TPX**







**FOLDING KEY SET MIXED 8 PIECES**

- Hex, TX and screwdriver key set
- A set of 8 keys
- Chrome vanadium steel with a black finish
- Retractable keys held in a fold up aluminium holder

Ergonomically Designed Aluminium Holder

Individual Keys:

	mm: 1 x 5.5
	PH1
	PZ2
	TX25 TX30
	mm: 4 5 6

Item ID: **1477NX**



**BICYCLE KEY SET 11 PIECES**

- Designed for cyclists to carry easily
- Includes hexagon, TX and screwdriver keys together with a tyre lever and chain repair tool
- Chrome nickel finish
- Supplied in a handy fold up aluminium case

Ergonomically Designed Aluminium Holder,  
Tyre lever, Chain tool

Individual Keys:

	mm: 1 x 5.5
	PH2
	TX25 TX30
	mm: 4 5 6

Item ID: **1473**



**TT**  
SERIES Hex & TX Key Sets available

**MODULAR TOOL CONTROL SYSTEM**



**PAGE 80**

**FOAM**  
SERIES Hex & TX Key Sets available

**MODULAR TOOL CONTROL SYSTEM**



**PAGE 141**

# PLIERS

## Designed to maximise performance

The extensive TengTools range includes pliers for most applications. In addition, the range includes the usual side cutters, combination pliers and slip joint pliers as well as a number of cable pliers, side cutters for cable ties, frapping pliers, nail nippers, electronic pliers, precision shears and tweezers. Two types of handles are available to choose from: slim rubber dipped as well as ergonomic TPR bi-material handles.

Made from chrome molybdenum alloy steel for maximum durability and strength

The cutting capacity is laser marked next to the cutting edge makes it easy to see which pliers you need to choose

**TPR  
GRIP**

An ergonomic bi-material handle that is more comfortable in your hand

Extra support when using greater force and a lighter weight

The total length is designed to provide maximum leverage for each pair of pliers, irrespective of whether they are combination, water pump, flat or circlip pliers

### VINYL GRIP

A light compact material that is textured to avoid the tool slipping in your hand. The slim design allows for greater access in tight spaces



Get Organised™







**SIDE CUTTING PLIER**

- Chrome molybdenum steel
- 80° cutting edge angle
- Electricians style function
- Vinyl grip for easier use in pockets or tool pouches
- DIN5749

ITEM ID:	Length			High Leverage	Cutting Capacity mm				Weight g
	AF	mm	GRIP		●	◐	◑	◒	
MB441-5	5	135	Vinyl	-	1.5	1.8	2.3	4	111
MB441-6	6	155	Vinyl	-	1.6	2	2.5	4	150
MB442-5	5	140	Vinyl	Y	1.5	1.8	2.3	4	180
MB442-6	6	160	Vinyl	Y	2	2.5	3.8	4	180
MB442-7	7	180	Vinyl	Y	2	2.5	4	4	220
MB442-8	8	200	Vinyl	Y	2.5	3	4	4	240



TPR GRIP

**SIDE CUTTING PLIER TPR GRIP**

- Chrome molybdenum steel
- 80° cutting edge angle
- Electricians style function
- TPR grip for a more secure and comfortable grip
- DIN5749

ITEM ID:	Length			High Leverage	Cutting Capacity mm				Weight g
	AF	mm	GRIP		●	◐	◑	◒	
MB441-5T	5	135	TPR	-	1.5	1.8	2.3	4	126
MB441-6T	6	155	TPR	-	1.6	2	2.5	4	176
MB442-6T	6	160	TPR	Y	2	2.5	3.8	4	199
MB442-8T	8	200	TPR	Y	2.5	3	4	4	275

●	Piano Wire	●	Steel Wire
◐	Hard Wire	●	Stainless Steel Wire
◑	Medium Hard Wire	●	Spring Steel Wire
◒	Soft Wire	Fe	Iron Wire



**HEAVY DUTY SIDE CUTTING PLIER WITH SPRING**

- Heavy duty with return spring
- Chrome molybdenum steel
- 80° cutting edge angle
- High leverage function for increased cutting capacity
- Vinyl grip for easier use in pockets or tool pouches
- DIN5749

ITEM ID:	Length			High Leverage	Cutting Capacity mm				Weight g
	AF	mm	GRIP		●	◐	◑	◒	
MB442-7S	7	180	Vinyl	Y	2	2.5	4	4	250



TPR GRIP

**ANGLED SIDE CUTTING PLIER TPR GRIP**

- Chrome molybdenum steel
- 80° cutting edge angle
- High leverage function for increased cutting capacity
- TPR grip for a more secure and comfortable grip
- DIN5749

ITEM ID:	Length			High Leverage	Cutting Capacity mm				Weight g
	AF	mm	GRIP		●	◐	◑	◒	
MB442B-8T	8	200	TPR	Y	2.5	3	4	4	275



### CABLE CUTTER

- One hand function with pitch guard for simple safe operation
- High carbon steel for durability and strength
- Vinyl grip for easier use in pockets or tool pouches

ITEM ID:	Length			Weight g
	AF	mm	GRIP	
MB444-6	6	160	Vinyl	181
MB444-8	8	200	Vinyl	322
MB444-10	10	250	Vinyl	381



TPR  
GRIP

### CABLE CUTTER TPR GRIP

- Ideal for cutting copper and aluminium cable up to 38mm<sup>2</sup>
- One hand function with pitch guard for simple safe operation
- High carbon steel for durability and strength
- TPR grip for a more secure and comfortable grip

ITEM ID:	Length			Capacity mm <sup>2</sup>	Weight g
	AF	mm	GRIP		
MB444-8T	8	208	TPR	38	347



TPR  
GRIP

### HEAVY DUTY CABLE CUTTER TPR HANDLE

- Drop forged
- Chrome molybdenum alloy hardened steel cutting blades
- Compound leverage action to increase cutting power
- Simple automatic latch design for one handed operation
- Cuts copper and aluminium electrical cables up to 12mm diameter
- Bi-material handles for a comfortable grip

ITEM ID:	Length			Capacity mm
	AF	mm	GRIP	
496	12	250	TPR	12



### HEAVY DUTY CABLE CUTTER

- Ideal for cutting copper and aluminium cable up to 60mm<sup>2</sup>
- One hand function with pitch guard for simple safe operation
- Chrome molybdenum for increased durability and strength
- Vinyl grip for easier use in pockets or tool pouches

ITEM ID:	Length			Capacity mm <sup>2</sup>	Weight g
	AF	mm	GRIP		
MB445-10	10	250	Vinyl	60	412



## Do's and Dont's of Pliers

### DO'S

- Use the right plier for the material
- Make sure the plier grips securely
- Use the right size plier
- Keep it clean & dry

### DONT'S

- Do not use a plier that does not grip or cut the material
- Do not use on live electrics





**MINI BOLT CUTTER**

- Chrome molybdenum alloy steel
- 80° cutting edge angle
- Induction hardened cutting edges (HRC58) for increased cutting capacity
- Return spring for easier operation
- Locking function for safe and secure storage
- Vinyl grip for easier use in pockets or tool pouches

ITEM ID:	Length			Cutting Capacity mm			Weight g
	AF	mm	GRIP			<b>F<sub>o</sub></b>	
BC408	8	200	Vinyl	3.6	4	5.2	260



**BOLT CUTTER**

- Hardened central cutting edge for durability
- 30° cutting angle for more efficient cutting
- Compound action for easier application of force
- Adjustable centering screw for increased safety when cutting
- Tubular handle with plastic grips for more comfortable use

ITEM ID:	Length			Capacity	Weight g
	AF	mm			
BC414	14"	350		7mm HRC15 or 4mm HRC40	1000
BC418	18"	450		8mm HRC15 or 5mm HRC40	1600
BC424	24"	600		10mm HRC15 or 6mm HRC40	2500
BC430	30"	750		13mm HRC15 or 7mm HRC40	3500
BC436	36"	900		16mm HRC15 or 8mm HRC40	5000



TPR GRIP

**MINI BOLT CUTTER TPR GRIP**

- Chrome molybdenum alloy steel
- 80° cutting edge angle
- Induction hardened cutting edges (HRC58) for increased cutting capacity
- Return spring for easier operation
- Locking function for safe and secure storage
- TPR grip for a more secure and comfortable grip

ITEM ID:	Length			Cutting Capacity mm			Weight g
	AF	mm	GRIP			<b>F<sub>o</sub></b>	
BC408T	8	200	TPR	3.6	4	5.2	275

**SPARE PARTS FOR BOLT CUTTERS**

- Replacement jaws for bolt cutters
- Includes replacement cutters and fittings
- Economical way to extend the life of the tool

ITEM ID:	For Bolt Cutters:
BC414J	BC414
BC418J	BC418
BC424J	BC424
BC430J	BC430
BC436J	BC436



**TT SERIES**

Plier Sets available

**MODULAR TOOL CONTROL SYSTEM**



**PAGE 81**

**FOAM SERIES**

Plier Sets available

**MODULAR TOOL CONTROL SYSTEM**



**PAGE 143**



**CABLE/WIRE CUTTER**

- Cuts up to 4.0mm stainless steel wire or 1.5mm spring steel cables
- Return spring mechanism for easier operation
- Vinyl grips make the tool more comfortable to use

ITEM ID:	Length			Cutting Capacity mm			Weight g
	AF	mm	GRIP				
498-7N	7	190	Vinyl	4	7	1.5	270



**END NIPPER**

- Chrome molybdenum alloy steel for durability and strength
- Vinyl grip for easier use in pockets or tool pouches
- DIN5748

ITEM ID:	Length			Cutting Capacity mm			Weight g
	AF	mm	GRIP				
MB448-6	6	160	Vinyl	1.6	1.8	3.4	200
MB448-8	8	200	Vinyl	1.6	1.8	3.4	250



**FLUSH CUT PLIER**

- Special shaped cutting angle - ideal for cutting cable tie tails flush
- Suitable for cutting other soft materials such as lead, tin, etc.
- Return spring for easier operation
- Vinyl grip for easier use in pockets or tool pouches

ITEM ID:	Length			Weight g
	AF	mm	GRIP	
MB541-5	5	125	Vinyl	100
MB541-6	6	150	Vinyl	143
MB541-7	7	180	Vinyl	227



**CARPENTERS PLIER**

- 85° cutting edge angle
- Vinyl grip for easier use in pockets or tool pouches

ITEM ID:	Length			Cutting Capacity mm		Weight g
	AF	mm	GRIP			
MB489-7	7	180	Vinyl	1.6	2	262
MB489-8	8	200	Vinyl	1.8	2.2	283



**TOWER PINCER PLIER**

- Chrome molybdenum alloy steel for durability and strength
- Vinyl grip for easier use in pockets or tool pouches

ITEM ID:	Length			Cutting Capacity mm			Weight g
	AF	mm	GRIP				
MB449-9	9	220	Vinyl	1.8	2	3.4	355
MB449-10	10	250	Vinyl	2	2.2	3.8	408
MB449-11	11	280	Vinyl	2.5	3	4	492

	Piano Wire		Steel Wire
	Hard Wire		Stainless Steel Wire
	Medium Hard Wire		Spring Steel Wire
	Soft Wire		Iron Wire



**COMBINATION PLIER**

- Features a pipe grip with serrated jaw for a more secure grip
- Chrome molybdenum alloy steel for durability and strength
- 80° cutting edge angle
- Vinyl grip for easier use in pockets or tool pouches
- DIN5746

ITEM ID:	Length			High Leverage	Cutting Capacity mm			Weight g
	AF	mm	GRIP		●	◐	◑	
MB451-7	7	180	Vinyl	N	1.8	2	3.8	195
MB451-8	8	200	Vinyl	N	2	2.2	4	253
MB452-6	6	160	Vinyl	Y	1.6	1.8	3.4	200
MB452-7	7	180	Vinyl	Y	1.8	2	3.8	210
MB452-8	8	200	Vinyl	Y	2	2.2	4	240
MB452-9	9	225	Vinyl	Y	2	2.2	4	380



**LONG NOSE PLIER**

- Long straight jaws for easier access
- Jaws with a serrated grip for increased gripping power
- Chrome molybdenum alloy steel for durability and strength
- 80° cutting edge angle
- Vinyl grip for easier use in pockets or tool pouches
- DIN5745

ITEM ID:	Length			Cutting Capacity mm			Weight g
	AF	mm	GRIP	●	◐	◑	
MB461-5	5	140	Vinyl	1	1.5	2.5	130
MB461-6	6	160	Vinyl	1	1.5	2.5	130
MB461-8	8	200	Vinyl	1.5	1.8	2.8	180



TPR GRIP

**HEAVY DUTY COMBINATION PLIER TPR GRIP**

- High leverage function for increased gripping and cutting power
- Features a pipe grip with serrated jaw for a more secure grip
- Chrome molybdenum alloy steel for durability and strength
- 80° cutting edge angle
- TPR grip for a more secure and comfortable grip
- DIN5746

ITEM ID:	Length			High Leverage	Cutting Capacity mm			Weight g
	AF	mm	GRIP		●	◐	◑	
MB452-6T	6	160	TPR	Y	1.6	1.8	3.4	210
MB452-7T	7	180	TPR	Y	1.8	2	3.8	220
MB452-8T	8	200	TPR	Y	2	2.2	4	266



TPR GRIP

**LONG NOSE PLIER TPR GRIP**

- Long straight jaws for easier access
- Jaws with a serrated grip for increased gripping power
- Chrome molybdenum alloy steel for durability and strength
- 80° cutting edge angle
- TPR grip for a more secure and comfortable grip
- DIN5745

ITEM ID:	Length			Cutting Capacity mm			Weight g
	AF	mm	GRIP	●	◐	◑	
MB461-6T	6	160	TPR	1	1.5	2.5	139
MB461-8T	8	200	TPR	1.5	1.8	2.8	185

● Piano Wire	● Steel Wire
◐ Hard Wire	● Stainless Steel Wire
◑ Medium Hard Wire	● Spring Steel Wire
◒ Soft Wire	● Fe Iron Wire



### BENT LONG NOSE PLIER

- Long 45° offset jaws for easier access
- Jaws with a serrated grip for increased gripping power
- Chrome molybdenum alloy steel for durability and strength
- 80° cutting edge angle
- Vinyl grip for easier use in pockets or tool pouches
- DIN5745

ITEM ID:	Length			Cutting Capacity mm			Weight g
	AF	mm	GRIP				
MB463-5	5	140	Vinyl	1	1.5	2.5	150
MB463-6	6	160	Vinyl	1	1.5	2.5	160
MB463-8	8	200	Vinyl	1.5	1.8	2.8	167



TPR  
GRIP

### BENT LONG NOSE PLIER TPR GRIP

- Long 45° offset jaws for easier access
- Jaws with a serrated grip for increased gripping power
- Chrome molybdenum alloy steel for durability and strength
- 80° cutting edge angle
- TPR grip for a more secure and comfortable grip
- DIN5745

ITEM ID:	Length			Cutting Capacity mm			Weight g
	AF	mm	GRIP				
MB463-8T	8	200	TPR	1.5	1.8	2.8	186



### FLAT NOSE PLIER

- Long straight jaws for easier access
- Chrome molybdenum alloy steel for durability and strength
- Vinyl grip for easier use in pockets or tool pouches
- DIN5745

ITEM ID:	Length			Weight g
	AF	mm	GRIP	
MB464-6	6	165	Vinyl	120



TPR  
GRIP

### FLAT NOSE PLIER TPR GRIP

- Long straight jaws for easier access
- Chrome molybdenum alloy steel for durability and strength
- TPR grip for a more secure and comfortable grip
- DIN5745

ITEM ID:	Length			Weight g
	AF	mm	GRIP	
MB464-6T	6	165	TPR	120



### ROUND NOSE PLIER

- Polished finish with a smooth tip
- Return spring for easier use
- Chrome molybdenum alloy steel for durability and strength
- Vinyl grip for easier use in pockets or tool pouches

ITEM ID:	Length			Weight g
	AF	mm	GRIP	
MB465-6	6	150	Vinyl	170



**LONG REACH PLIER**

- The long reach enables the plier to reach in to recessed areas
- Body hardness HRC43-48 for long lasting use
- Vinyl grips make the tool more comfortable to use

ITEM ID:	Length			Type	Weight g
	AF	mm	GRIP		
AT096	11	275	Vinyl	Straight	300
AT097	11	275	Vinyl	Angled 45	300



**WATER PUMP PLIER**

- Pipe grip with serrated jaws for increased grip
- Chrome vanadium steel construction
- Vinyl grip for easier use in pockets or tool pouches

ITEM ID:	Length			Jaw Depth mm	Jaw Opening mm	Weight g
	AF	mm	GRIP			
MB481-7	7	180	Vinyl	28	35	159
MB481-10	10	250	Vinyl	30	38	175



**GROOVE JOINT WATER PUMP PLIER**

- Serrated jaws for a more secure grip
- Non slip groove joints for use with higher force
- Chrome vanadium with a polished head
- Vinyl grip for easier use in pockets or tool pouches

ITEM ID:	Length			Jaw Depth mm	Jaw Opening mm	Weight g
	AF	mm	GRIP			
MB410	10	250	Vinyl	35	45	425
MB412	12	300	Vinyl	45	60	600
MB416	16	400	Vinyl	60	90	1330



**WATER PUMP PLIER TPR GRIP**

- Pipe grip with serrated jaws for increased grip
- Chrome vanadium steel construction
- TPR grip for a more secure and comfortable grip

ITEM ID:	Length			Jaw Depth mm	Jaw Opening mm	Weight g
	AF	mm	GRIP			
MB481-7T	7	180	TPR	28	35	344
MB481-10T	10	250	TPR	30	38	371



**QUICK SET WATER PUMP PLIER HRC60**

- Simply position the upper jaw against the work piece and press the button to close the jaw - quick, simple and time saving
- Pipe grip with serrated jaws for increased grip
- Shaped to protect the operators fingers

ITEM ID:	Length			Jaw Depth mm	Jaw Opening mm	Weight g
	AF	mm	GRIP			
MB482-7Q	7	190	Vinyl	30	38	182
MB482-10Q	10	250	Vinyl	35	49	335

	Piano Wire		Steel Wire
	Hard Wire		Stainless Steel Wire
	Medium Hard Wire		Spring Steel Wire
	Soft Wire		Iron Wire



### QUICK SET WATER PUMP PLIER

- Simply position the upper jaw against the work piece and press the button to close the jaw - quick, simple and time saving
- Pipe grip with serrated jaws for increased grip
- Shaped to protect the operators fingers

ITEM ID:	Length		GRIP	Jaw Depth mm	Jaw Opening mm	Weight g
	AF	mm				
MB481-10Q	10	250	Vinyl	35	39	380



**TPR**  
GRIP

### QUICK SET WATER PUMP PLIER TPR GRIP

- Simply position the upper jaw against the work piece and press the button to close the jaw - quick, simple and time saving
- Pipe grip with serrated jaws for increased grip
- Shaped to protect the operators fingers

ITEM ID:	Length		TPR	Jaw Depth mm	Jaw Opening mm	Weight g
	AF	mm				
MB481-10TQ	10	250	TPR	35	39	405



**TPR**  
GRIP

### QUICK SET WATER PUMP PLIER TPR GRIP HRC60

- Simply position the upper jaw against the work piece and press the button to close the jaw - quick, simple and time saving
- Pipe grip with serrated jaws for increased grip
- Shaped to protect the operators fingers

ITEM ID:	Length		TPR	Jaw Depth mm	Jaw Opening mm	Weight g
	AF	mm				
MB482-10TQ	10	250	TPR	35	49	359

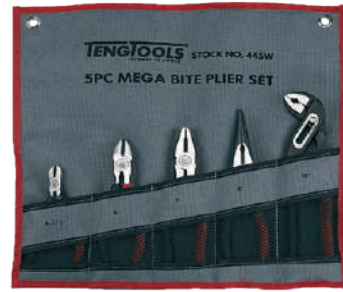

**5**  
Pieces

### PLIER SET TOOL ROLL 5 PIECES

- All the most commonly used pliers in one set
- All the pliers have a vinyl grip for easier use in pockets or tool pouches
- Supplied in a heavy duty tool roll storage wallet

Pliers:	
SIDE CUTTER	4 1/2" / 110 mm
COMBINATION PLIERS	6" / 155 mm
LONG NOSE PLIERS	7" / 180 mm
WATER PUMP PLIERS	10" / 250 mm

Item ID: **445W**



### ALUMINIUM PIPE WRENCH

- Lightweight aluminium construction
- Sturdy design with steel jaws and adjustment thread
- One hand operation

ITEM ID:	Length		Capacity		Weight g
	mm	AF	mm	AF	
PWC12	300	12"	43	1-11/16"	670
PWC14	350	14"	50	1-31/32"	860
PWC18	450	18"	60	2-23/64"	1390
PWC24	600	24"	76	3"	2220
PWC36	900	36"	102	4-1/64"	4030





**WIRE STRIPPING PLIER TPR GRIP**

- Medium carbon alloy steel construction
- With adjuster screw to suit wire diameters from 0.2 to 4.5mm
- Return spring for easier operation
- TPR grip for a more secure and comfortable grip

ITEM ID:	Length			Capacity mm	Weight g
	mm	AF	GRIP		
MB499-7T	155	6	TPR	0.2 - 4.5	175



**MINI END CUTTING PLIER**

- 68° cutting angle angle
- Cuts up to 0.8mm wire
- High carbon steel construction
- Return spring for easier operation
- Vinyl grip for easier use in pockets or tool pouches

ITEM ID:	Length			Capacity mm	Weight g
	mm	AF	GRIP		
MBM449	110	4 ½	Vinyl	0.8	70



**MINI SIDE CUTTING PLIER**

- 68° cutting angle angle
- Cuts up to 0.8mm wire
- High carbon steel construction
- Return spring for easier operation
- Vinyl grip for easier use in pockets or tool pouches

ITEM ID:	Length			Capacity mm	Weight g
	mm	AF	GRIP		
MBM441	125	5	Vinyl	0.8	67



**MINI LONG NOSE PLIER**

- Long straight jaws for easier access
- 68° cutting angle angle
- Cuts up to 0.8mm wire
- High carbon steel construction
- Return spring for easier operation
- Vinyl grip for easier use in pockets or tool pouches

ITEM ID:	Length			Capacity mm	Weight g
	mm	AF	GRIP		
MBM461	125	5	Vinyl	0.8	81





**MINI FLAT NOSE PLIER**

- Long straight jaws for easier access
- High carbon steel construction
- Return spring for easier operation
- Vinyl grip for easier use in pockets or tool pouches

ITEM ID:	Length			Weight g
	mm	AF	GRIP	
MBM464	125	5	Vinyl	85



**MINI NEEDLE NOSE PLIER**

- Long straight jaws for easier access
- High carbon steel construction
- Return spring for easier operation
- Vinyl grip for easier use in pockets or tool pouches

ITEM ID:	Length			Weight g
	mm	AF	GRIP	
MBM468	150	6	Vinyl	75



**MINI ROUND NOSE PLIER**

- Long straight jaws for easier access
- High carbon steel construction
- Return spring for easier operation
- Vinyl grip for easier use in pockets or tool pouches

ITEM ID:	Length			Weight g
	mm	AF	GRIP	
MBM467	125	5	Vinyl	71



**MINI BENT LONG NOSE PLIER**

- Long offset straight jaws for easier access
- High carbon steel construction
- Return spring for easier operation
- Vinyl grip for easier use in pockets or tool pouches

ITEM ID:	Length			Weight g
	mm	AF	GRIP	
MBM469	150	6	Vinyl	78



**TT SERIES** Plier Sets available

**MODULAR TOOL CONTROL SYSTEM**



**PAGE 81**

**FOAM SERIES** Plier Sets available

**MODULAR TOOL CONTROL SYSTEM**



**PAGE 143**



**SELF LOCKING PLIER**

- Serrated jaw for improved grip
- Made from special grade stainless steel suitable for use in special environments
- Three step lock function and precision joint construction for precise gripping
- Matt finish
- Hot drop forged construction for greater strength and durability

ITEM ID:	Length		Jaw Type		Weight g
	mm	AF			
SLP2180	180	7	Straight	Serrated	45
SLP3160	160	6	Curved	Serrated	50
SLP3180	180	7	Curved	Serrated	58



**STRAIGHT TWEEZERS**

- Serrated jaw for improved grip
- Made from special grade stainless steel suitable for use in special environments
- Matt finish
- Hot drop forged construction for greater strength and durability

ITEM ID:	Length mm	Tip Type		Weight g
		Straight	Serrated	
TW1160	160	Straight	Serrated	37
TW1180	180	Straight	Serrated	37



**BENT TWEEZERS SERRATED JAW**

- Serrated jaw for improved grip
- Made from special grade stainless steel suitable for use in special environments
- Matt finish
- Hot drop forged construction for greater strength and durability

ITEM ID:	Length mm	Tip Type		Weight g
		Bent	Serrated	
TW2125	125	Bent	Serrated	29



**BENT TWEEZERS SMOOTH JAW**

- Serrated jaw for improved grip
- Made from special grade stainless steel suitable for use in special environments
- Matt finish
- Hot drop forged construction for greater strength and durability

ITEM ID:	Length mm	Tip Type		Weight g
		Bent	Smooth	
TW2160	160	Bent	Smooth	42



**Z SHAPE NEEDLE TIPS TWEEZERS**

- Serrated jaw for improved grip
- Made from special grade stainless steel suitable for use in special environments
- Matt finish
- Hot drop forged construction for greater strength and durability

ITEM ID:	Length mm	Tip Type		Weight g
		Z Shape	Needle Tip	
TW2180	170	Z Shape	Needle Tip	35



### CIRCLIP PLIER INTERCHANGEABLE TIPS

- 10-50mm capacity covering a wide range of applications
- Interchangeable heads for bent or straight with 1.2 and 1.5mm tips
- Inner or Outer fitting giving 8 different possible combinations
- Magnetic tips to help hold the circlip when inserting or removing, especially useful with smaller circlips
- A return spring gives smooth and easy operation
- Vinyl grips make the tool more comfortable to use

Handle:

REVERSIBLE, SPRING LOADED HANDLE WITH LOCKING PIN

Magnetic Tips:

	INNER / OUTER	TIP
STRAIGHT	INNER / OUTER	1.2 mm TIP
	INNER / OUTER	1.5 mm TIP
45° TIP	INNER / OUTER	
90° TIP	INNER / OUTER	

Item ID: **480**



INVISIBLE RETURN SPRING



### CIRCLIP PLIER INNER STRAIGHT PRO

- Invisible return spring for easier operation
- For use with inner type circlips or snap rings
- Bearing steel tips for heavy duty applications
- Non slip tip angle enabling the ring to stock securely to the tip when compressing or expanding the circlip
- Chrome vanadium construction
- Vinyl grip for easier use in pockets or tool pouches
- DIN 5256

ITEM ID:	Length		Capacity	Type	Tip	Weight
	mm	AF				
MBE470-5	140	5	12-25	Straight	Inner	1.3 80
MBE470-7	185	7	19-60	Straight	Inner	1.8 150
MBE470-9	235	9	40-100	Straight	Inner	2.3 295

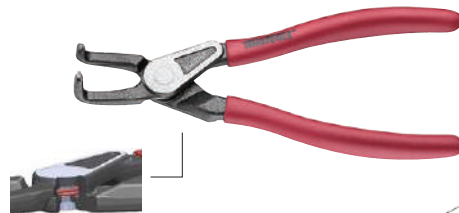

INVISIBLE RETURN SPRING



### CIRCLIP PLIER INNER BENT PRO

- Invisible return spring for easier operation
- For use with inner type circlips or snap rings
- Bearing steel tips for heavy duty applications
- Non slip tip angle enabling the ring to stock securely to the tip when compressing or expanding the circlip
- Chrome vanadium construction
- Vinyl grip for easier use in pockets or tool pouches
- DIN 5256

ITEM ID:	Length		Capacity	Type	Tip	Weight
	mm	AF				
MBE471-5	125	5	12-25	Bent	Inner	1.3 80
MBE471-7	170	7	19-60	Bent	Inner	1.8 150
MBE471-9	215	9	40-100	Bent	Inner	2.3 295



**CIRCLIP PLIER OUTER STRAIGHT PRO**

- Invisible return spring for easier operation
- For use with outer type circlips or snap rings
- Bearing steel tips for heavy duty applications
- Non slip tip angle enabling the ring to stock securely to the tip when compressing or expanding the circlip
- Chrome vanadium construction
- Vinyl grip for easier use in pockets or tool pouches
- DIN5254

ITEM ID:	Length		Capacity	Type	Tip	Weight
	mm	AF				
MBE472-5	140	5	12-25	Straight	Outer	1.3 90
MBE472-7	185	7	19-60	Straight	Outer	1.8 170
MBE472-9	235	9	40-100	Straight	Outer	2.3 310



**CIRCLIP PLIER INNER STRAGHT**

- For use with inner type circlips or snap rings
- Chrome vanadium construction
- Return spring for easier use
- Vinyl grip for easier use in pockets or tool pouches
- DIN 5256

ITEM ID:	Length		Capacity	Type	Tip	Weight
	mm	AF				
MB470-5	130	5	12-25	Straight	Inner	1.3 100
MB470-7	175	7	19-60	Straight	Inner	1.8 134
MB470-9	225	9	40-100	Straight	Inner	2.3 160



**CIRCLIP PLIER OUTER BENT PRO**

- Invisible return spring for easier operation
- For use with outer type circlips or snap rings
- Bearing steel tips for heavy duty applications
- Non slip tip angle enabling the ring to stock securely to the tip when compressing or expanding the circlip
- Chrome vanadium construction
- Vinyl grip for easier use in pockets or tool pouches
- DIN5254

ITEM ID:	Length		Capacity	Type	Tip	Weight
	mm	AF				
MBE473-5	125	5	12-25	Bent	Outer	1.3 90
MBE473-7	170	7	19-60	Bent	Outer	1.8 170
MBE473-9	215	9	40-100	Bent	Outer	2.3 310



**CIRCLIP PLIER INNER BENT**

- For use with inner type circlips or snap rings
- Chrome vanadium construction
- Return spring for easier use
- Vinyl grip for easier use in pockets or tool pouches
- DIN 5256

ITEM ID:	Length		Capacity	Type	Tip	Weight
	mm	AF				
MB471-5	130	5	12-25	Bent	Inner	1.3 100
MB471-7	175	7	19-60	Bent	Inner	1.8 134
MB471-9	225	9	40-100	Bent	Inner	2.3 160



### CIRCLIP PLIER OUTER STRAIGHT

- For use with outer type circlips or snap rings
- Chrome vanadium construction
- Return spring for easier use
- Vinyl grip for easier use in pockets or tool pouches
- DIN5254

ITEM ID:	Length		Capacity mm	Type	Tip mm	Weight g
	mm	AF				
MB472-5	130	5	12-25	Straight	Outer	1.3 100
MB472-7	175	7	19-60	Straight	Outer	1.8 134
MB472-9	225	9	40-100	Straight	Outer	2.3 160



### CIRCLIP PLIER OUTER BENT

- For use with outer type circlips or snap rings
- Chrome vanadium construction
- Return spring for easier use
- Vinyl grip for easier use in pockets or tool pouches
- DIN5254

ITEM ID:	Length		Capacity mm	Type	Tip mm	Weight g
	mm	AF				
MB473-5	130	5	12-25	Bent	Outer	1.3 100
MB473-7	175	7	19-60	Bent	Outer	1.8 134
MB473-9	225	9	40-100	Bent	Outer	2.3 160



### CURVED JAW POWER GRIP PLIER

- Self locking with release lever
- With locking nut on adjustment knob for pre-setting, ideal for repeated use
- Wire cutter and crimper function
- Chrome molybdenum

ITEM ID:	Length		Capacity mm	Weight g
	AF	mm		
401-4	4	100	25	75
401-5	5	125	28	180
401-7	7	180	38	345
401-10	10	250	47	514
401-12	12	300	50	680



### FLAT JAW POWER GRIP PLIER

- Self locking with release lever
- With locking nut on adjustment knob for pre-setting, ideal for repeated use
- Chrome molybdenum

ITEM ID:	Length		Capacity mm	Weight g
	AF	mm		
401-10F	10	250	45	527
401-12F	12	300	52	693





**LONG NOSE POWER GRIP PLIER**

- Self locking with release lever
- With locking nut on adjustment knob for pre-setting, ideal for repeated use
- Wire cutter and crimper function
- Chrome molybdenum

ITEM ID:	Length		Capacity mm	Weight g
	AF	mm		
404-4	4	100	35	180
404-6	6	155	35	197
404-9	9	230	70	380

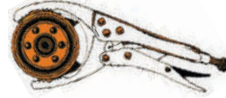
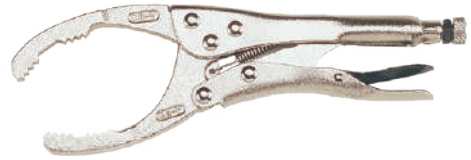

**OIL FILTER REMOVAL PLIER**

- 53-118mm capacity to suit most oil filters
- Two stage grip areas on the jaws for added versatility
- Ideal for removing and installing objects of many shapes when a tight grip is required
- Chrome vanadium with drop forged jaws, heat treated and nickel plated

Item ID: **409**



**LONG NOSE GRIP PLIER NON PINCH**

- Narrow jaw for use in confined spaces
- Self locking with non pinch, one handed operation release lever
- With locking nut on adjustment knob for pre-setting, ideal for repeated use
- Wire cutter and crimper function
- Chrome molybdenum



ITEM ID:	Length		Capacity mm	Weight g
	AF	mm		
404-6S	6	160	35	185



**POWER GRIP PLIER SET**

- The two most commonly used types in one handy set
- Self locking with release lever
- With locking nut on adjustment knob for pre-setting, ideal for repeated use
- Wire cutter and crimper function
- Chrome molybdenum

Power Grip Pliers:	
STANDARD ROUND JAW	10" / 250 mm
LONG NOSE	6" / 155 mm

Item ID: **402**



### C CLAMP POWER GRIP PLIER

- Self locking with release lever
- With locking nut on adjustment knob for pre-setting, ideal for repeated use
- Chrome vanadium with nickel plating

ITEM ID:	L mm	L AF	Capacity mm	Throat Depth mm	Throat Height mm	Weight g
406-6	172	6"	0-50	40	60	235
406	280	11"	0-80	70	100	772



### C CLAMP POWER GRIP PLIER NON PINCH

- Non pinch one hand operation for easier use
- Self locking with release lever
- With locking nut on adjustment knob for pre-setting, ideal for repeated use
- Chrome vanadium with nickel plating

ITEM ID:	L mm	L AF	Capacity mm	Throat Depth mm	Throat Height mm	Weight g
406-6S	172	6"	0-50	40	60	235
406S	285	11"	0-80	70	100	760



## Power Grip Pliers

- **Choose the right size:** Power grip pliers come in various sizes
- **Adjust the jaws:** Use the adjustment screw located near the handle to adjust the jaws to the desired width. Make sure the jaws are parallel and evenly spaced.
- **Apply the pliers:** Place the jaws of the power grip pliers around the object you want to grip. Close the jaws by squeezing the handles together.
- **Lock the pliers:** To lock the pliers in place, flip the small lever near the handle to the "locked" position. This will keep the pliers closed and maintain a firm grip on the object.
- **Apply force:** Use the power grip pliers to apply force, such as tightening or loosening a bolt or holding a piece of material in place.
- **Release the pliers:** To release the pliers, flip the lever back to the "unlocked" position and open the jaws by releasing the handles.

It's important to note that power grip pliers are a powerful tool and should be used with care. Always wear safety goggles when using them and avoid using excessive force that could damage the object you are working on or cause injury.



## TT SERIES

Plier Sets available

### MODULAR TOOL CONTROL SYSTEM



PAGE 81

## FOAM SERIES

Plier Sets available

### MODULAR TOOL CONTROL SYSTEM



PAGE 143





**SWIVEL C CLAMP POWER GRIP PLIER**

- Swivel pads for a self levelling grip when clamping
- Self locking with release lever
- With locking nut on adjustment knob for pre-setting, ideal for repeated use
- Chrome vanadium

ITEM ID:	L mm	L AF	Capacity mm	Throat Depth mm	Throat Height mm	Weight g
406-6P	172	6"	0-50	40	60	235
406P	280	11"	0-80	70	100	772



**SWIVEL C CLAMP GRIP PLIER NON PINCH**

- Swivel pads for a self levelling grip when clamping
- Non pinch one hand operation for easier use
- Self locking with release lever
- With locking nut on adjustment knob for pre-setting, ideal for repeated use
- Chrome vanadium with nickel plating

ITEM ID:	L mm	L AF	Capacity mm	Throat Depth mm	Throat Height mm	Weight g
406-6SP	172	6"	0-50	40	60	235
406SP	285	11"	0-80	70	100	760



**C CLAMP LONG POWER GRIP PLIER**

- Self locking with release lever
- With locking nut on adjustment knob for pre-setting, ideal for repeated use
- Chrome vanadium

ITEM ID:	L mm	L AF	Capacity mm	Throat Depth mm	Throat Height mm	Weight g
418S	450	18"	0-150	250	130	1192



**SWIVEL C CLAMP LONG POWER GRIP PLIER**

- Swivel pad for a self levelling grip when clamping
- Self locking with release lever
- With locking nut on adjustment knob for pre-setting, ideal for repeated use
- Chrome vanadium

ITEM ID:	L mm	L AF	Capacity mm	Throat Depth mm	Throat Height mm	Weight g
418SP	450	18"	0-150	250	130	1192



**WELDING POWER GRIP PLIER**

- Self locking with release lever
- With locking nut on adjustment knob for pre-setting, ideal for repeated use
- Chrome vanadium

ITEM ID:	L mm	L AF	Capacity mm	Weight g
407	230	9"	0-65	580



### WELDING POWER GRIP PLIER NON PINCH

- Non pinch one hand operation for easier use
- Self locking with release lever
- With locking nut on adjustment knob for pre-setting, ideal for repeated use
- Chrome vanadium with nickel plating

ITEM ID:	L mm	L AF	Gap Width mm	Jaw Depth mm	Weight g
407AS	270	11"	90	85	855



### SWIVEL CLAMPING GRIP PLIER NON PINCH

- Swivel pads for a self levelling grip when clamping
- Non pinch one hand operation for easier use
- Self locking with release lever
- With locking nut on adjustment knob for pre-setting, ideal for repeated use
- Chrome vanadium with nickel plating

ITEM ID:	L mm	L AF	Gap Width mm	Weight g
409SP	300	12"	88	740



### SHEET METAL POWER GRIP PLIER

- Self locking with release lever
- With locking nut on adjustment knob for pre-setting, ideal for repeated use
- Chrome vanadium

ITEM ID:	L mm	L AF	Capacity mm	Weight g
408	230	8"	0-35	580



### TABLE CLAMP

- Swivel pad for a self levelling grip when clamping
- Non pinch one hand operation for easier use
- Self locking with release lever
- With locking nut on adjustment knob for pre-setting, ideal for repeated use

ITEM ID:	L mm	Clamping Height mm	Clamp Hole mm	Weight g
410SP	230	65	4	580
410P	320	65	10	580



### SWIVEL CLAMPING POWER GRIP PLIER

- Swivel pads for a self levelling grip when clamping
- Non pinch one hand operation for easier use
- Self locking with release lever
- With locking nut on adjustment knob for pre-setting, ideal for repeated use
- Chrome vanadium with nickel plating

ITEM ID:	L mm	L AF	Capacity mm	Weight g
409P	300	12"	0-65	580



# INSULATED TOOLS

## Protect yourself from electric shock

All 1000-volt tools from TengTools conform to or exceed all specifications that the relevant authorities have established. Each tool is individually tested before it is marked with a special standard tag and a marking that indicates the year of manufacture.



### INSULATED SCREWDRIVERS

The bi-material handle is designed for increased comfort and smooth action preventing blisters after continuous use. It gives better support and increased power transfer.

Size and tip marked at the bottom of each handle for easy identification

Integrated protective insulation with two colours to clearly indicate if there is any damage to the insulation

RBD shafts are ultra slim allowing for recessed screws to be accessed easily



TT-MV PLUS steel alloy for greater strength and material flexibility



### INSULATED RATCHET

Twist reverse mechanism for quickly changing between tightening and loosening

Insulation made in two parts, yellow insulating core and a red outer layer. Any damage to the insulation can be detected quickly with the visibility of the yellow core layer

72 Teeth ratchet give a working arc of just 5° making it ideal for working in confined spaces

Insulation properties have been tested in resistance to cold and fire as well as in pressurised environments

Ergonomically designed handle for increased comfort and smooth action



Get Organised™

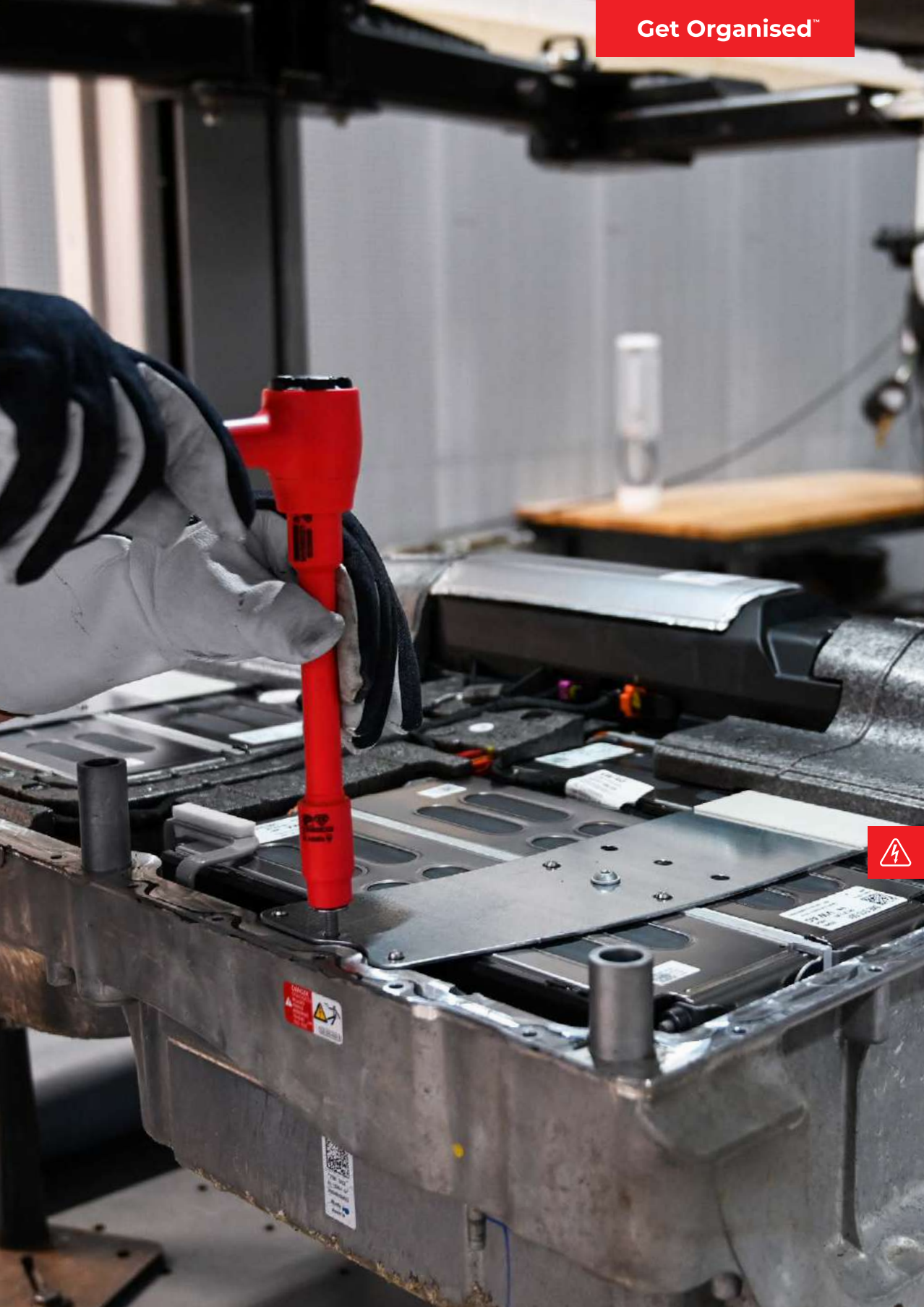

CAUTION  
High Voltage  
Electrical  
Shock Hazard  
Always use  
proper safety  
procedures.



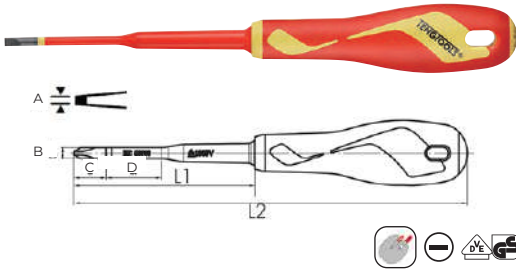

**FLAT SLIM INSULATED SCREWDRIVER**

- Reduced blade diameter giving an ultra slim blade for easier access
- Approved for live working up to 1,000 volts
- Integrated protective insulation with two colours to clearly indicate if there is any damage to the insulation
- For use with slotted screws
- TT-MV PLUS steel alloy for greater strength and material flexibility
- Ergonomically designed bi-material handle for easy use with higher torque
- Designed and manufactured to DIN 2380 and IEC 60900

ITEM ID:	a mm	b mm	c mm	d mm	Shaft	L1 mm	L2 mm	Weight g	HDL
MDV724N	0.8	4	15	31.5	RBD	100	208	51	M
MDV726N	1	5.5	15	31.5	RBD	125	233	66	M

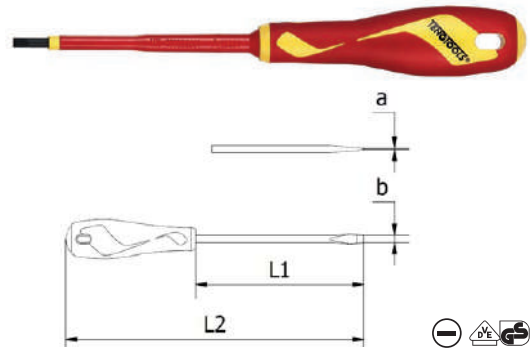

**FLAT INSULATED SCREWDRIVER**

- Approved for live working up to 1,000 volts
- Integrated protective insulation with two colours to clearly indicate if there is any damage to the insulation
- For use with slotted screws
- TT-MV PLUS steel alloy for greater strength and material flexibility
- Ergonomically designed bi-material handle for easy use with higher torque
- Designed and manufactured to DIN 2380 and IEC 60900

ITEM ID:	a mm	b mm	Shaft	L1 mm	L2 mm	Weight g	HDL
MDV820N	0.4	2.5	Straight	75	171	49	S
MDV822N	0.5	3	Straight	100	196	56	S
MDV823N	0.6	3.5	Straight	100	196	58	S
MDV824N	0.8	4	Straight	100	208	60	M
MDV826N	1	5.5	Straight	125	233	89	M
MDV828N	1.2	6.5	Straight	150	266	135	L



Insulated according to IEC 60900, usable up to 1000 V  
 VDE tested, also in conformance to GPSG (Equipment and Product Safety Act)  
 Reduced blade diameter (RBD)



**TT SERIES** Insulated Sets available  
**MODULAR TOOL CONTROL SYSTEM**  
**PAGE 85**

**FOAM SERIES** Insulated Sets available  
**MODULAR TOOL CONTROL SYSTEM**  
**PAGE 146**

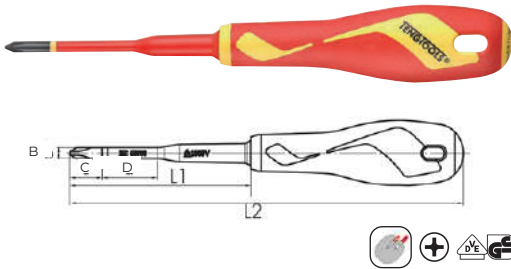
**PH SLIM INSULATED SCREWDRIVER**

- Reduced blade diameter giving an ultra slim blade for easier access
- Approved for live working up to 1,000 volts
- Integrated protective insulation with two colours to clearly indicate if there is any damage to the insulation
- For use with Phillips type screws
- TT-MV PLUS steel alloy for greater strength and material flexibility
- Ergonomically designed bi-material handle for easy use with higher torque
- Designed and manufactured to DIN 2380 and IEC 60900

ITEM ID:	⊕	b	c	d	Shaft	L1	L2	Weight	HDL
		mm	mm	mm		mm	mm	g	
MDV742N	PH1	4.5	18	30	RBD	80	188	51	M
MDV744N	PH2	6	18	30.5	RBD	100	216	95	L

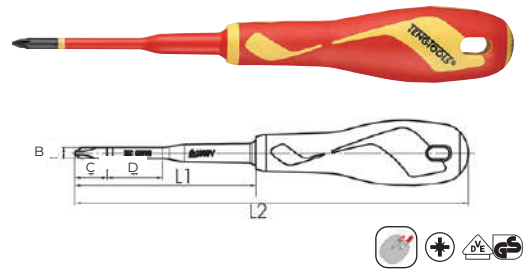
**PZ SLIM INSULATED SCREWDRIVER**

- Reduced blade diameter giving an ultra slim blade for easier access
- Approved for live working up to 1,000 volts
- Integrated protective insulation with two colours to clearly indicate if there is any damage to the insulation
- For use with Pozidriv type screws
- TT-MV PLUS steel alloy for greater strength and material flexibility
- Ergonomically designed bi-material handle for easy use with higher torque
- Designed and manufactured to DIN 2380 and IEC 60900

ITEM ID:	⊕	b	c	d	Shaft	L1	L2	Weight	HDL
		mm	mm	mm		mm	mm	g	
MDV762N	PZ1	4.5	18	30	RBD	80	188	51	M
MDV764N	PZ2	6	18	30.5	RBD	100	216	95	L

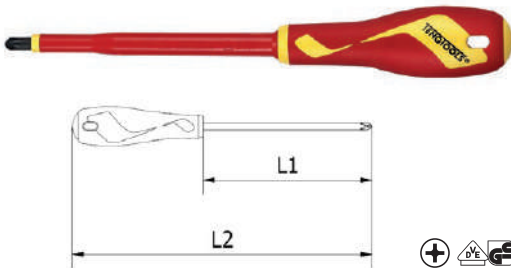
**PH INSULATED SCREWDRIVER**

- Approved for live working up to 1,000 volts
- Integrated protective insulation with two colours to clearly indicate if there is any damage to the insulation
- For use with Phillips type screws
- TT-MV PLUS steel alloy for greater strength and material flexibility
- Ergonomically designed bi-material handle for easy use with higher torque
- Designed and manufactured to DIN 2380 and IEC 60900

ITEM ID:	⊕	Shaft	L1	L2	Weight	HDL
			mm	mm	g	
MDV840N	PH0	Straight	60	156	49	S
MDV842N	PH1	Straight	80	188	54	M
MDV844N	PH2	Straight	100	216	118	L
MDV846N	PH3	Straight	150	275	177	XL

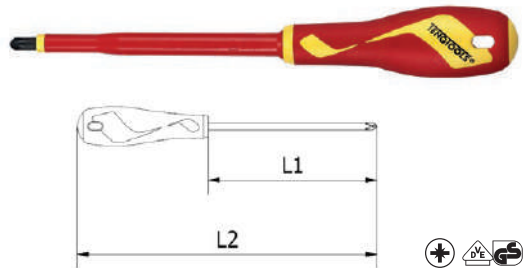
**PZ INSULATED SCREWDRIVER**

- Approved for live working up to 1,000 volts
- Integrated protective insulation with two colours to clearly indicate if there is any damage to the insulation
- For use with Pozidriv type screws
- TT-MV PLUS steel alloy for greater strength and material flexibility
- Ergonomically designed bi-material handle for easy use with higher torque
- Designed and manufactured to DIN 2380 and IEC 60900

ITEM ID:	⊕	Shaft	L1	L2	Weight	HDL
			mm	mm	g	
MDV860N	PZ0	Straight	60	156	49	S
MDV862N	PZ1	Straight	80	188	54	M
MDV864N	PZ2	Straight	100	216	118	L
MDV866N	PZ3	Straight	150	275	177	XL



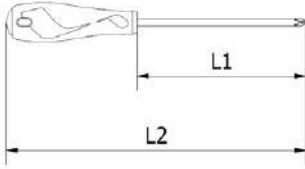

**FLAT/PH INSULATED SCREWDRIVER**

- Approved for live working up to 1,000 volts
- Integrated protective insulation with two colours to clearly indicate if there is any damage to the insulation
- TT-MV PLUS steel alloy for greater strength and material flexibility
- Ergonomically designed bi-material handle for easy use with higher torque
- Designed and manufactured to IEC 60900

ITEM ID:		Shaft	L1 mm	L2 mm	Weight g	HDL
MDV844NF	Slotted/PH2	Straight	100	216	118	L
MDV864NF	Slotted/PZ2	Straight	100	216	118	L

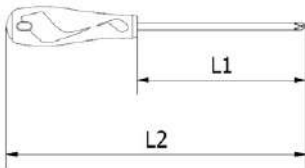

**ROB INSULATED SCREWDRIVER**

- Approved for live working up to 1,000 volts
- Integrated protective insulation with two colours to clearly indicate if there is any damage to the insulation
- For use with ROB type screws with a square hole
- TT-MV PLUS steel alloy for greater strength and material flexibility
- Ergonomically designed bi-material handle for easy use with higher torque
- Designed and manufactured to IEC 60900

ITEM ID:		Shaft	L1 mm	L2 mm	Weight g	HDL
MDV802N	ROB2	Straight	100	216	118	L

Insulated according to IEC 60900, usable up to 1000 V  
VDE tested, also in conformance to GPSPG (Equipment and Product Safety Act)

Reduced blade diameter (RBD)

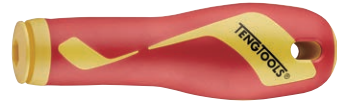

**LARGE INSULATED HANDLE FOR INTERCHANGEABLE BLADES**

- Approved for live working up to 1,000 volts
- Integrated protective insulation with two colours to clearly indicate if there is any damage to the insulation
- For use 1000V interchangeable blades
- Ergonomically designed bi-material handle for easy use with higher torque
- Designed and manufactured to IEC 60900

ITEM ID:	Length mm	Height mm	Width mm	Weight g	HDL
MDV700	122	36.7	37	66 g	L



**SMALL INSULATED HANDLE FOR INTERCHANGEABLE BLADES**

- Approved for live working up to 1,000 volts
- Integrated protective insulation with two colours to clearly indicate if there is any damage to the insulation
- For use 1000V interchangeable blades
- Ergonomically designed bi-material handle for easy use with higher torque
- Designed and manufactured to IEC 60900

ITEM ID:	Length mm	Height mm	Width mm	Weight g	HDL
MDV710	100	23	23	26g	S



### INSULATED INTERCHANGE- ABLE SCREWDRIVERS BLADES

- Approved for live working up to 1,000 volts
- For use with 1000V handles
- Designed and manufactured to IEC 60900

ITEM ID:	Tip	Shaft	Length mm	Weight g	
MDV731	⊖	3	Straight	111	9 g
MDV732	⊖	4	RBD	151	15 g
MDV733	⊖	5.5	RBD	131	21 g
MDV734	⊖	6.5	RBD	151	28 g
MDV751	⊕	PH1	RBD	131	15 g
MDV752	⊕	PH2	RBD	151	26 g
MDV771	⊕	PZ1	RBD	131	15 g
MDV772	⊕	PZ2	RBD	151	26 g



### INSULATED SCREWDRIVER SET FLAT & PH

- Approved for live working up to 1,000 volts
- Integrated protective insulation with two colours to clearly indicate if there is any damage to the insulation
- Designed and manufactured to DIN ISO 2380, DIN ISO 8764 and IEC60900

1000V Insulated Screwdrivers:

⊖	mm:	2.5 x 75	3 x 100	4 x 100	5.5 x 125
⊕	mm:	PH1 x 80	PH2 x 100		

Item ID: **MDV906N**



## What are our insulated tools tested for?

- Insulation properties, i.e. resistance up to 1000 volts in dry or humid environments.
- Resistance to the cold, i.e. how well the tool withstands the cold
- Durability, i.e. that the insulating handles do not come loose
- Resistance to fire, i.e. how well the tool withstands fire
- Insulating properties under pressure, i.e. how well the tool maintains its insulating properties when subjected to pressure



**TT  
SERIES** Insulated Sets available

**MODULAR TOOL CONTROL SYSTEM**



**PAGE 85**

**FOAM  
SERIES** Insulated Sets available

**MODULAR TOOL CONTROL SYSTEM**



**PAGE 146**





**1/4" INSULATED TORQUE SCREWDRIVER 1-5NM**

- Approved for live working up to 1,000 volts
- Torque screwdriver covering 1-5Nm for our VDE interchangeable blades
- Slipper mechanism ensures that no torque is applied beyond the set torque
- Simple to adjust and easy to read window Nm scale
- Push locking facility to ensure the set torque is maintained
- Accurate to +/- 6% and conforms to ISO6789 for assured reliability and accuracy
- Individually tested and certified at the time of manufacture
- Each torque wrench has it's own individual certification number for easier quality control management
- Design and manufactured to IEC 60900

ITEM ID:	Range Nm
1492TVSD	1-5



**INSULATED SIDE CUTTING PLIER**

- Approved for live working up to 1,000 volts
- Chrome molybdenum steel
- 80° cutting edge angle
- Electricians style function
- TPR grip for a more secure and comfortable grip
- Designed and manufactured to DIN5749 and IEC60900

ITEM ID:	Length			Cutting Capacity mm			Weight
	AF	mm	GRIP	●	◐	◑	g
MBV441-6	6"	150	TPR	1.6	2.0	2.5	206



**HEAVY DUTY INSULATED SIDE CUTTING PLIER**

- Approved for live working up to 1,000 volts
- Chrome molybdenum steel
- 80° cutting edge angle
- Electricians style function
- TPR grip for a more secure and comfortable grip
- Designed and manufactured to DIN5749 and IEC60900

ITEM ID:	Length			Cutting Capacity mm			Weight
	AF	mm	GRIP	●	◐	◑	g
MBV442-8	8"	200	TPR	2.5	3.0	4.0	305



**TT SERIES** Insulated Sets available

**MODULAR TOOL CONTROL SYSTEM**



**PAGE 85**

**FOAM SERIES** Insulated Sets available

**MODULAR TOOL CONTROL SYSTEM**



**PAGE 146**



### INSULATED COMBINATION PLIER

- Approved for live working up to 1,000 volts
- Features a pipe grip with serrated jaw for a more secure grip
- Chrome molybdenum alloy steel for durability and strength
- 80° cutting edge angle
- TPR grip for a more secure and comfortable grip
- Designed and manufactured to DIN5746 and IEC60900

ITEM ID:	Length			Cutting Capacity mm			Weight g
	AF	mm	GRIP	●	◐	◑	
MBV451-7	7"	175	TPR	1.8	2.0	3.8	225
MBV451-8	8"	200	TPR	2.0	2.2	4.0	283



### INSULATED WIRE STRIPPING PLIER

- 7" 1,000 volt insulated wire stripping pliers
- Approved for live working up to 1,000 volts
- Medium carbon alloy steel construction
- With adjuster screw to suit wire diameters from 0.2 to 4.5mm
- Return spring for easier operation
- TPR grip for a more secure and comfortable grip
- Designed and manufactured to IEC 60900

ITEM ID:	Length			Stripping Capacity mm	Weight g
	AF	mm	GRIP		
MBV499-7	6"	155	TPR	0.2 - 4.5	175



### INSULATED LONG NOSE PLIER

- Approved for live working up to 1,000 volts
- Long straight jaws for easier access
- Jaws with a serrated grip for increased gripping power
- Chrome molybdenum alloy steel for durability and strength
- 80° cutting edge angle
- TPR grip for a more secure and comfortable grip
- Designed and manufactured to DIN5745 and IEC60900

ITEM ID:	Length			Cutting Capacity mm			Weight g
	AF	mm	GRIP	●	◐	◑	
MBV461-8	8"	200	TPR	1.5	1.8	2.8	199



### INSULATED PLIER SET WALL RACK 4 PIECES

- Approved for live working up to 1,000 volts
- TPR grip for a more secure and comfortable grip
- Supplied with a wall rack for fixing to the wall or a workbench
- Designed and manufactured to DIN5745, DIN5746, DIN5749 and IEC60900

1000V Insulated Pliers:	
SIDE CUTTER	6" / 150 mm
HEAVY DUTY SIDE CUTTERS	8" / 200 mm
LONG NOSE	8" / 200 mm
COMBINATION PLIERS	7" / 175 mm

Item ID: **WRMBV04**



Insulated according to IEC 60900, usable up to 1000 V

VDE tested, also in conformance to GPSG (Equipment and Product Safety Act)

- Piano Wire
- Hard Wire
- Medium Hard Wire

MECCA PRO™



**MECCA PRO INSULATED SCREWDRIVER & PLIER SET 18 PIECES**

- Approved for live working up to 1,000 volts
- Screwdrivers with Integrated protective insulation with two colours to clearly indicate if there is any damage to the insulation
- TPR grip on the pliers and bi-material handles on the screwdrivers for a more secure and comfortable grip
- Hard wearing case with tools laid out to easily identify where tools belong
- Secure lock system to ensure that the lid is closed correctly
- Designed and manufactured to IEC 60900

1000V Screwdrivers:

	mm:	2.5 x 75	3 x 100	4 x 100	5.5 x 125	6.5 x 150
	mm:	PH0 x 60	PH1 x 80	PH2 x 100	PH3 x 150	
	mm:	PZ0 x 60	PZ1 x 80	PZ2 x 100	PZ3 x 150	

1000V Pliers:

6" side cutters, 8" heavy duty side cutters, 8" combination, 8" long nose, 7" wire strippers

Item ID: **TV18N**



**TT SERIES** Insulated Sets available

**MODULAR TOOL CONTROL SYSTEM**



**PAGE 85**



**3/8" DRIVE INSULATED RATCHET**

- Approved for live working up to 1,000 volts
- 72 teeth giving 5 degree increments between clicks
- Twist reverse for quickly and easily changing between tightening and loosening
- Design and manufactured to DIN3122D and IEC60900

ITEM ID:	Drive	Reverse	No. of Teeth	Length mm	Weight g
MV3800	3/8"	Twist	72	200	343



**3/8" DRIVE INSULATED EXTENSION BAR**

- Approved for live working up to 1,000 volts
- Integrated protective insulation with two colours to clearly indicate if there is any damage
- Ball recess on the female end to grip the ratchet
- Ball socket retainer on the male end to securely grip the socket
- Chrome vanadium
- Design and manufactured to DIN3123B and IEC60900

ITEM ID:	Drive	Length mm	Weight g
MV380020	3/8"	75	77
MV380021	3/8"	150	135

**FOAM SERIES** Insulated Sets available

**MODULAR TOOL CONTROL SYSTEM**



**PAGE 146**

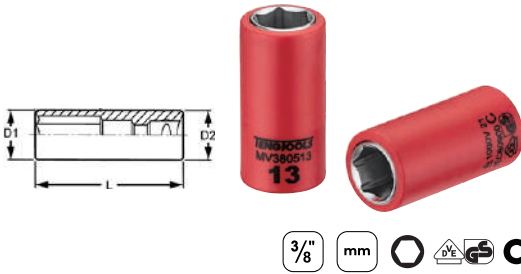

### 3/8" DRIVE INSULATED SOCKETS

- Approved for live working up to 1,000 volts
- Integrated protective insulation with two colours to clearly indicate if there is any damage
- 6 point single hexagon socket for a better grip
- Chrome vanadium
- Ball recess on the female end to grip the ratchet
- Design and manufactured to DIN3120/3124, ISO2725 and IEC 60900

ITEM ID:	Size mm	L mm	D1 mm	D2 mm	Weight g
MV380506	6	46	14.8	23	29
MV380507	7	46	15.7	23	29
MV380508	8	46	17	23	30
MV380509	9	46	18.2	23	31
MV380510	10	46	19.4	23	31
MV380511	11	46	20.7	23	32
MV380512	12	46	23	23	33
MV380513	13	46	23	23	37
MV380514	14	46	24.7	23	39
MV380515	15	46	26	23	40
MV380516	16	46	26.8	23	42
MV380517	17	46	29	23	47
MV380518	18	46	29.6	23	49
MV380519	19	46	30.7	23	53
MV380520	20	46	32.2	23	55



**Manufactured to the highest standard**

IEC 60 900 is an international standard for testing tools designed for electrical work on the production line

DIN EN 60900 is a European standard drawn up in 1995 and which states that each individual tool must be tested with regard to insulation for 1000 volts

VDE is an independent authority that tests and checks tools with regard to construction, production and packaging



# CUTTING TOOLS

## Built to last

TengTools tool boxes and tool cabinets have been designed to meet the high demands made by professionals from all over the world. No details are left to chance when our tool boxes and roller cabinets are manufactured.

A full range of storage accessories, side tables, side drawers and tool panels are available and can be placed on both sides of all TengTools roller cabinets.





**STRAIGHT CUT TIN SNIPS**

- Chrome molybdenum alloy steel drop forged cutting blades
- Cuts up to 1.5mm steel or 0.9mm stainless steel
- Spring loaded high leverage handles for increased cutting capacity
- Safety lock for safe storage
- Bi-material grip for more comfortable use

ITEM ID:	Length	Type	Handle	Steel mm	Stainless Steel mm
490	10"	Straight	Yellow	1.5	0.9



**STRAIGHT/LEFT CUT TIN SNIPS**

- Chrome molybdenum alloy steel drop forged cutting blades
- Cuts up to 1.5mm steel or 0.9mm stainless steel
- Spring loaded high leverage handles for increased cutting capacity
- Safety lock for safe storage
- Bi-material grip for more comfortable use

ITEM ID:	Length	Type	Handle	Steel mm	Stainless Steel mm
492	10"	Straight/Left	Red	1.5	0.9



**STRAIGHT/RIGHT CUT TIN SNIPS**

- Chrome molybdenum alloy steel drop forged cutting blades
- Cuts up to 1.5mm steel or 0.9mm stainless steel
- Spring loaded high leverage handles for increased cutting capacity
- Safety lock for safe storage
- Bi-material grip for more comfortable use

ITEM ID:	Length	Type	Handle	Steel mm	Stainless Steel mm
491	10"	Straight/Right	Grey	1.5	0.9



**OFF SET STRAIGHT/RIGHT TIN SNIPS**

- Cuts up to 1.5mm steel or 0.9mm stainless steel
- Blade angle designed to cut towards the left/right depending on model when cutting curves
- Also cuts in a straight line
- Bi-material grip for more comfortable use

ITEM ID:	Length	Type	Steel mm	Stainless Steel mm
493	10"	Off set/Right	1.5	0.9





**OFF SET STRAIGHT/LEFT TIN SNIPS**

- Cuts up to 1.5mm steel or 0.9mm stainless steel
- Blade angle designed to cut towards the left/right depending on model when cutting curves
- Also cuts in a straight line
- Bi-material grip for more comfortable use

ITEM ID:	Length	Type	Steel mm	Stainless Steel mm
494	10"	Off set/Left	1.5	0.9



**LONG BLADE STRAIGHT CUT TIN SNIPS**

- Chrome molybdenum alloy steel drop forged cutting blades
- Cuts up to 0.9mm cold rolled steel or 0.53mm stainless steel
- Spring loaded high leverage handles for increased cutting capacity
- Safety lock for safe storage
- Bi-material grip for more comfortable use

ITEM ID:	Length	Type	Steel mm	Stainless Steel mm
495	11"	Straight/Long cut	0.9	0.53



**HIGH LEVERAGE STRAIGHT CUT TIN SNIPS**

- Chrome molybdenum alloy steel drop forged cutting blades
- Cuts up to 1.5mm cold rolled steel or 0.9mm stainless steel
- Spring loaded high leverage handles for increased cutting capacity
- Double spring with high torsional strength for frequent use
- Safety lock for safe storage
- Ergonomically designed handle for more comfortable use

ITEM ID:	Length	Type	Copper mm	Steel mm	Hard Steel mm	Stainless Steel mm
490W	10"	Straight	1.8	1.5	1	0.9



**HIGH LEVERAGE RIGHT/STRAIGHT CUT TIN SNIPS**

- Chrome molybdenum alloy steel drop forged cutting blades
- Cuts up to 1.5mm cold rolled steel or 0.9mm stainless steel
- Spring loaded high leverage handles for increased cutting capacity
- Double spring with high torsional strength for frequent use
- Safety lock for safe storage
- Ergonomically designed handle for more comfortable use

ITEM ID:	Length	Type	Copper mm	Steel mm	Hard Steel mm	Stainless Steel mm
491W	10"	Straight/Right	1.8	1.5	1	0.9



**HIGH LEVERAGE LEFT/STRAIGHT CUT TIN SNIPS**

- Chrome molybdenum alloy steel drop forged cutting blades
- Cuts up to 1.5mm cold rolled steel or 0.9mm stainless steel
- Spring loaded high leverage handles for increased cutting capacity
- Double spring with high torsional strength for frequent use
- Safety lock for safe storage
- Ergonomically designed handle for more comfortable use

ITEM ID:	Length	Type	Copper mm	Steel mm	Hard Steel mm	Stainless Steel mm
492W	10"	Straight/Left	1.8	1.5	1	0.9



**SCISSOR**

- High carbon stainless steel blades for accurate cutting
- Cutting capacity of 22mm in soft materials
- Bi-material grip for added comfort

ITEM ID:	Length mm	Blade Length mm	Capacity mm
497	138	42	22



**INTRICATE CUTTING SCISSOR**

- Straight cutting jaws
- Sharp cutting edge
- Special grade stainless steel
- Hot drop forged for strength
- Matt finish

ITEM ID:	Length mm	Blade Type	Weight g
SR1160	160	straight, sharp	61
SR1180	180	straight, sharp	77
SR2180	180	straight, blunt	69
SR3160	160	curved, sharp	61



**HACKSAW BLADE HOLDER**

- Plastic with a non slip handle
- Suitable for use with any standard 12" hacksaw blades
- Supplied with a TengTools 12" hacksaw blade
- Ideal for use as a key hole saw

Item ID: **704**



**HACKSAW**

- Ergonomically designed aluminium handle
- Soft rubber grip area on the handle and frame for a better grip
- 12" Swedish steel M2 HSS 24 TPI blade for consistent quality
- Includes facility for presetting at a 45° or 90° cutting angles

ITEM ID:	Description
701N1	Hacksaw frame
702	2 spare 24 teeth blades



**HACKSAW**

- Ergonomically designed aluminium handle
- Soft rubber grip area on the handle and frame for a better grip
- 12" Swedish steel M2 HSS 24 TPI blade for consistent quality
- Includes facility for presetting at a 45° or 90° cutting angles

ITEM ID:	Description
701N	Hacksaw frame
702	2 spare 24 teeth blades

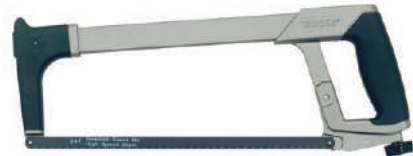

**HACKSAW**

- Ergonomically designed aluminium handle
- Soft rubber grip area on the handle and frame for a better grip
- 12" Swedish steel M2 HSS 24 TPI blade for consistent quality
- Includes facility for presetting at a 45° or 90° cutting angles

ITEM ID:	Description
701	Hacksaw frame
702	2 spare 24 teeth blades





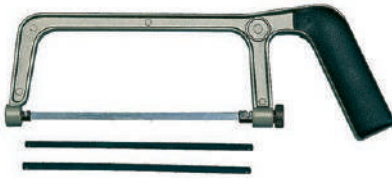

**MINI HACKSAW**

- Mini hacksaw fram with blades for both metal and wood/ plastic.

ITEM ID:	Description
705	Mini hacksaw frame
705-5	5 spare blades



**MINI HACKSAW**

- Mini hacksaw fram with blades for both metal and wood/ plastic.

ITEM ID:	Description
705A	Mini hacksaw frame
705A-5	16 teeth blade for wood
705-5	5 spare blades



3 Pieces

**HACKSAW AND KNIFE SET**

- Professional quality hacksaws for technicians and engineers

Contents:
12" Hacksaw
Junior Hacksaw
Utility Knife

Item ID: **700-PRO5**

**NEW**



**FOLDING UTILITY SAW**

- Quick change blade function.
- The blade can be adjusted in 3 positions (135°, 180°, 225°)
- Hole in the handle for hanging or securing.
- Ergonomic handle with soft material.
- Accepts all reciprocating saw blades for increased versatility

ITEM ID:	Description
703A	Folding Utility Saw
703A-10	Spare Blade For 703A Wood/Plastic 10 TPI
703A-24	Spare Blade For 703A Metal 24 TPI



**TT SERIES** Cutting Sets available

**MODULAR TOOL CONTROL SYSTEM**



**PAGE 87**



## Do's and Don'ts of Hacksaws

### DO'S

- **Use the right blade:** Choose the right blade for the material you are cutting. A fine-toothed blade for thin metal, and a coarse-toothed blade for thicker materials.
- **Wear protective gear:** Wear safety glasses and gloves to protect yourself from flying debris.
- **Use the correct technique:** Hold the saw with both hands and use long, smooth strokes. Avoid twisting or bending the blade.
- **Keep the saw blade lubricated:** Lubricate the saw blade with a light oil to reduce friction.
- **Store the saw properly:** Store the saw in a dry place with the blade covered.

### DONT'S

- **Force the saw:** Do not apply excessive pressure on the saw, as this can damage the blade or cause it to break.
- **Use a dull blade:** Do not use a dull blade, as this can cause the saw to become stuck or make rough cuts.
- **Twist or bend the blade:** Do not twist or bend the blade while cutting, as this can cause it to break or become damaged.
- **Use the wrong blade:** Do not use the wrong blade for the material you are cutting, as this can cause the blade to wear down quickly or break.
- **Ignore safety gear:** Do not forget to wear protective gear such as safety glasses and gloves, as this can increase your risk of injury.



### SNAP OFF KNIFE 9 MM

- Metal casing with a break off tool for removing blunt blade sections
- Sliding blade holder to retract blade when not in use
- Handy pocket clip

ITEM ID:	Description
710A	Snap Off Knife
710A-10	10 spare 9mm blades



### SNAP OFF KNIFE WITH 9MM BLADE

- Metal casing with a break off tool for removing blunt blade sections
- Sliding blade holder to retract blade when not in use
- Handy pocket clip

ITEM ID:	Description
710H	Snap Off Knife
710A-10	10 spare 9mm blades



### SNAP OFF KNIFE WITH 9MM BLADE

- Metal casing with a break off tool for removing blunt blade sections
- Sliding blade holder to retract blade when not in use
- Handy pocket clip

ITEM ID:	Description
710F	Snap Off Knife
710A-10	10 spare 9mm blades





**SNAP OFF KNIFE 18 MM**

- Plastic casing with a break off tool for removing blunt blade sections
- Slide locking mechanism to lock the blade in place at any position, in or out
- Sliding metal blade holder to retract blade when not in use
- Handy pocket clip

ITEM ID:	Description
710C	Snap Off Knife
710F-10	10 spare 18mm blades



**SNAP OFF KNIFE WITH 18MM BLADE**

- Plastic casing with a break off tool for removing blunt blade sections
- Slide locking mechanism to lock the blade in place at any position, in or out
- Sliding metal blade holder to retract blade when not in use
- Handy pocket clip

ITEM ID:	Description
710G	Snap Off Knife
710F-10	10 spare 18mm blades

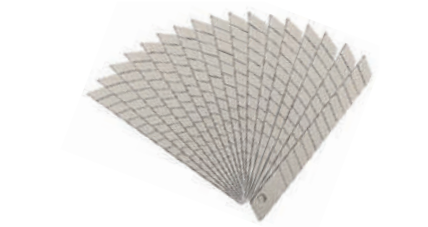

**SPARE BLADES**

- Spare 9mm break off blades for TengTools craft knives

Item ID: **710A-100**

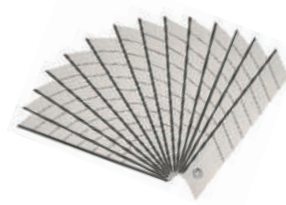

**SPARE BLADES**

- Spare 18mm break off blades for TengTools craft knives

Item ID: **710F-100**



4 Pieces

**SNAP OFF KNIFE SET 4 PIECES**

- 2 Knives with 9mm snap off blades and 2 with 18mm snap off blades

Contents:
9mm blade with metal body
9mm blade with plastic body
18mm blade with plastic body
18mm blade with plastic body and position lock

Item ID: **710S**





### MINI FOLDING UTILITY KNIFE

- Knife folds away in to a pocket knife
- Locking mechanism prevents accidental opening of the knife
- Retractable blade with simple slide action for changing blades

ITEM ID:	Description
P-UKF	Utility knife
710U-10	10 spare blades



### QUICK ACTION UTILITY KNIFE

- Ergonomically designed handle with soft non slip grip area
- Retractable 3 step blade for safer use and storage
- Storage for spare blades with quick opening and closing action
- Supplied with 2 spare TengTools blades

ITEM ID:	Description
710N	Utility knife
710-10	10 spare blades



### FOLDING UTILITY KNIFE

- Knife folds away in to a pocket knife
- Locking mechanism prevents accidental opening of the knife
- Retractable blade with simple slide action for changing blades
- Supplied with 3 TengTools utility knife blades

ITEM ID:	Description
712	Utility knife
710-10	10 spare blades



### SAFETY UTILITY KNIFE

- Bi-material plastic handle for a more comfortable grip
- Non slip grip area for a more secure grip
- Features an automatic blade return mechanism
- Handy release button for quickly and easily ejecting used blades
- Replacement blade automatically inserted from the internal storage section
- Supplied with 6 blades stored in the handle

ITEM ID:	Description
711	Utility knife
710-10	10 spare blades



### UTILITY KNIFE

- Retractable blade for safer use and storage
- Storage for spare blades with screw lock access
- Supplied with 2 spare TengTools blades

ITEM ID:	Description
710	Utility knife
710-10	10 spare blades



### SPARE BLADES

- Spare blades for TengTools utility knives

Item ID: **710-100**





**SPARE BLADES**

- Spare hook type blades for TengTools utility knives

Item ID: **710-10H**



**REPLACEMENT HOOK BLADES UTILITY KNIFE**

- Spare hook type blades for TengTools utility knives

Item ID: **710-100H**



**DRILL BITS FULLY GROUND**

- Fully ground drill bit
- Standard drill bits for use in steel and cast iron, etc
- Spiral angle of 28° to expel swarf etc
- Point angle of 118° and a split point for better positional accuracy
- Designed and manufactured to DIN338

ITEM ID:	Size mm	Flute Length mm	Overall Length mm	Pack Qty
DBX010	1	12	34	10
DBX015	1.5	18	40	10
DBX020	2	24	49	10
DBX025	2.5	30	57	10
DBX030	3	33	61	10
DBX033	3.3	36	65	10
DBX035	3.5	39	70	10
DBX040	4	43	75	10
DBX042	4.2	43	75	10
DBX045	4.5	47	80	10
DBX050	5	52	86	10
DBX055	5.5	57	93	10
DBX060	6	57	93	10
DBX065	6.5	63	101	10
DBX068	6.8	69	109	10
DBX070	7	69	109	10
DBX075	7.5	69	109	10
DBX080	8	75	117	5
DBX085	8.5	75	117	5
DBX090	9	81	125	5
DBX095	9.5	81	125	5
DBX100	10	87	133	5
DBX105	10.5	87	133	5
DBX110	11	94	142	5
DBX115	11.5	94	142	5
DBX120	12	101	151	5
DBX125	12.5	101	151	5
DBX130	13	101	151	5



**TT**  
SERIES

Cutting Sets available

**MODULAR TOOL CONTROL SYSTEM**



**PAGE 87**



28  
Pieces



### DRILL BIT SET 1.0-10.0 MM 28 PIECES

- Standard drill bits for use in steel and cast iron, etc
- Spiral angle of 28° to expel swarf etc
- Point angle of 118° and a split point for better positional accuracy
- Designed and manufactured to DIN338

Fully Ground Drill Bits:

1.0(x4), 1.5(x3), 2.0(x2), 2.5, 3.0, 3.3, 3.5, 4.0, 4.2, 4.5, 5.0, 5.5, 6.0, 6.5, 6.8, 7.0, 7.5, 8.0, 8.5, 9.0, 9.5, 10.0

Item ID: **DB028**



34  
Pieces



### DRILL BIT SET 1.0-13.0 MM 34 PIECES

- Standard drill bits for use in steel and cast iron, etc
- Spiral angle of 28° to expel swarf etc
- Point angle of 118° and a split point for better positional accuracy
- Designed and manufactured to DIN338

Fully Ground Drill Bits:

1.0(x4), 1.5(x3), 2.0(x2), 2.5, 3.0, 3.3, 3.5, 4.0, 4.2, 4.5, 5.0, 5.5, 6.0, 6.5, 6.8, 7.0, 7.5, 8.0, 8.5, 9.0, 9.5, 10.0, 10.5, 11.0, 11.5, 12.0, 12.5, 13.0

Item ID: **DB034**



### TAPS

- Suitable for repairing damaged threads
- Made from SK5 carbon steel
- Hardness 58 ±5

ITEM ID:	Size	Description
TDT03050	M3 x 0.5	Spare Tap
TDT04070	M4 x 0.7	Spare Tap
TDT05080	M5 x 0.8	Spare Tap
TDT06100	M6 x 1.0	Spare Tap
TDT08125	M8 x 1.25	Spare Tap
TDT10150	M10 x 1.5	Spare Tap
TDT12175	M12 x 1.75	Spare Tap



### TAP HANDLE

- Individual tap handle for use with TengTools rethreading taps
- Also suitable for use with TengTools screw extractors
- Suitable for M3 to M12 tap sizes

Item ID: **TAP-HNDL**





**1/4" TAP CHUCK**

- Suitable for use with TengTools taps
- Use with a 1/4" drive ratchet
- Satin finish with a knurled grip for a better grip when handling

ITEM ID:	Drive	For Taps	Chuck Diameter
M140071	1/4"	3-8	20
M140072	1/4"	5-12	25

**REPAIR KIT ADJUSTABLE TAP CHUCK**

- Service kit for repairing tap chucks

ITEM ID:	Suitable For
M140071RK	M140071
M140072RK	M140072



**DIES**

- Suitable for repairing damaged threads
- Made from SK5 carbon steel
- Hardness 58 ±5

ITEM ID:	Size	Diameter mm	Description
TDD03050	M3 x 0.5	25	Spare Die
TDD04070	M4 x 0.7	25	Spare Die
TDD05080	M5 x 0.8	25	Spare Die
TDD06100	M6 x 1.0	25	Spare Die
TDD08125	M8 x 1.25	25	Spare Die
TDD10150	M10 x 1.5	25	Spare Die
TDD12175	M12 x 1.75	25	Spare Die



**DIE HANDLE**

- Individual die handle for use with TengTools rethreading dies
- Suitable for M3 to M12 die sizes, diameter 25mm

Item ID: **DIE-HNDL**



**1/4" DIE CHUCK**

- Suitable for use with TengTools M3 to M12 dies, diameter 25mm
- Use with a 1/4" drive ratchet
- Satin finish for a better grip when handling

Item ID: **M140070**



5 Pieces

**SCREW EXTRACTOR SET 5 PIECES**

- Tapered design for removing damage screws
- Suitable for both clockwise and anti-clockwise threads
- Square shank and manufactured in CR-V 6150 steel hardened to HRC50-52
- Use with drill sizes 3, 4, 5, 7 and 9mm
- Use with the TengTools tap handle (TAP-HDL)
- Supplied in the unique TengTools TJ module
- Clear fold up lid to see which set you need to use
- Sliding catch to secure the set when not in use
- Box equipped with a belt clip to keep tools in easy reach

Item ID: **TJSE05S**

**NEEDLE FILE HAND**

- 160mm long with a plastic handle for use with more detailed work
- Smooth cut
- Hand file type

Item ID: **TTNF12-01****NEEDLE FILE KNIFE TYPE**

- 160mm long with a plastic handle for use with more detailed work
- Smooth cut
- Hand file type

Item ID: **TTNF12-07****NEEDLE FILE HALF ROUND**

- 160mm long with a plastic handle for use with more detailed work
- Smooth cut
- Hand file type

Item ID: **TTNF12-02****NEEDLE FILE BARRETTE**

- 160mm long with a plastic handle for use with more detailed work
- Smooth cut
- Hand file type

Item ID: **TTNF12-08****NEEDLE FILE THREE SQUARE**

- 160mm long with a plastic handle for use with more detailed work
- Smooth cut
- Hand file type

Item ID: **TTNF12-03****NEEDLE FILE CROSSING**

- 160mm long with a plastic handle for use with more detailed work
- Smooth cut
- Hand file type

Item ID: **TTNF12-09****NEEDLE FILE SQUARE**

- 160mm long with a plastic handle for use with more detailed work
- Smooth cut
- Hand file type

Item ID: **TTNF12-04****NEEDLE FILE OVAL**

- 160mm long with a plastic handle for use with more detailed work
- Smooth cut
- Hand file type

Item ID: **TTNF12-10****NEEDLE FILE ROUND**

- 160mm long with a plastic handle for use with more detailed work
- Smooth cut
- Hand file type

Item ID: **TTNF12-05****NEEDLE FILE FEATHER EDGE**

- 160mm long with a plastic handle for use with more detailed work
- Smooth cut
- Hand file type

Item ID: **TTNF12-11****NEEDLE FILE FLAT POINT**

- 160mm long with a plastic handle for use with more detailed work
- Smooth cut
- Hand file type

Item ID: **TTNF12-06****NEEDLE FILE ROUND EDGE**

- 160mm long with a plastic handle for use with more detailed work
- Smooth cut
- Hand file type

Item ID: **TTNF12-12**





### HAND FILE - FLAT

- 10" hand file
- High carbon steel for durability and strength
- Bi-material handle for a more comfortable grip
- 2nd cut to create a diamond pattern cutting surface for smoother filing
- Cut on both edges for filing grooves, etc

Item ID: **FLFT10**



### HAND FILE - HALF ROUND

- 10" hand file
- High carbon steel for durability and strength
- Bi-material handle for a more comfortable grip
- 2nd cut to create a diamond pattern cutting surface for smoother filing
- Cut on both edges for filing grooves, etc

Item ID: **FLHR10**



### HAND FILE - FLAT

- 10" hand file
- High carbon steel for durability and strength
- Bi-material handle for a more comfortable grip
- 2nd cut to create a diamond pattern cutting surface for smoother filing
- Cut on both edges for filing grooves, etc

Item ID: **FLHF10**



### HAND FILE - ROUND

- 10" hand file
- High carbon steel for durability and strength
- Bi-material handle for a more comfortable grip
- 2nd cut to create a diamond pattern cutting surface for smoother filing
- Cut on both edges for filing grooves, etc

Item ID: **FLRD10**



### HAND FILE - SQUARE

- 10" hand file
- High carbon steel for durability and strength
- Bi-material handle for a more comfortable grip
- 2nd cut to create a diamond pattern cutting surface for smoother filing
- Cut on both edges for filing grooves, etc

Item ID: **FLSQ10**



### HAND FILE - TRIANGULAR

- 10" hand file
- High carbon steel for durability and strength
- Bi-material handle for a more comfortable grip
- 2nd cut to create a diamond pattern cutting surface for smoother filing
- Cut on both edges for filing grooves, etc

Item ID: **FLTR10**



# MEASURING TOOLS

## Accuracy is key

Our range of Measuring Tools have been developed by focusing on TengTools users requirements across the automotive & industrial sectors. All tools are available individually but are also available in the unique TengTools TT trays so you can add them to your existing tool kit or include them when you are building your ultimate tool kit.

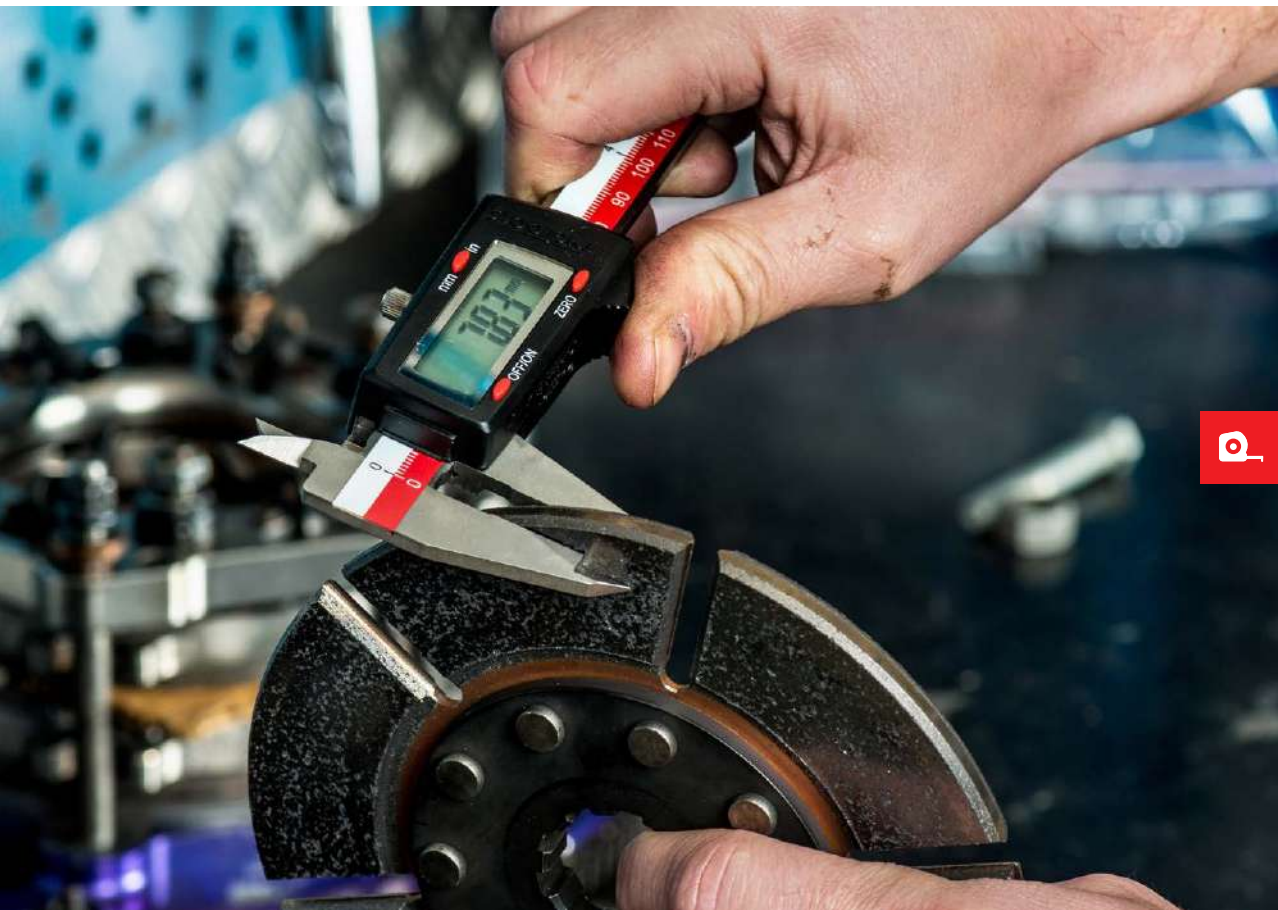



**MICROMETER**

- Friction thimble and locking nut for easy operation
- Forged frame with hardened steel and polished measuring surfaces
- Matt chrome plated scale for easy reading
- Supplied with a plastic storage case
- Designed and manufactured to DIN863

Specifications:		
Measuring range	mm	0-25
Reading	mm	0.01
Precision	mm	0.004

Item ID: **MIR25**



**DIGITAL CALIPER**

- 4 function caliper to measure height, width, depth and step
- Adjustable between mm and inches
- Reset button and zero set in any position
- Automatic switch off to conserve batteries
- 0.01mm reading scale with 8mm high figures
- Uses CR2032 batteries (supplied)
- Supplied with a plastic storage case
- Designed and manufactured to DIN862

Specifications:		
Length of measurement	mm	150
Jaw length	mm	40
Height of figures	mm	8
Resolution	mm	0.01
Accuracy	mm	±0.02

Item ID: **CALD150**



**VERNIER CALIPER**

- 4 function caliper to measure height, width, depth and step
- Metric and inch scales with 0.05mm and 1/128" scales
- Frosted chrome plated scale for easier reading
- Stainless steel construction with lapped edges
- Supplied with a plastic storage case
- Designed and manufactured to DIN862

Specifications:		
Length of measurement	mm	150
Jaw length	mm	40

Item ID: **CALV150**



**FEELER GAUGE**

- Blades for measuring from 0.05mm to 1.0mm
- Hardened rolled steel for durability and accuracy
- Fold up case with tightening screw for easy storage
- Manufactured according to Din 2275/T2 standard

ITEM ID:	No. of Blades	Blade Length	
		mm	
FG13100	13	100	
FG20100	20	100	
FG20200	20	200	



**THREAD GAUGE MM/UNC 54 BLADES**

- 54 blades in a handy holder with tightening screws
- Thread gauge 60°
- Suitable for measuring metric and UNC threads
- Manufactured from #45 steel for a long lasting gauge

Metric thread gauges:

0.25, 0.3, 0.35, 0.4, 0.45, 0.5, 0.6, 0.7, 0.75, 0.8, 0.9, 1.0, 1.25, 1.5, 1.75, 2.0, 2.5, 3.0, 3.5, 4.0, 4.5, 5.0, 5.5, 6.0

UNC thread gauges:

4, 4 ½, 5, 5 ½, 6, 7, 8, 9, 10, 11, 11 ½, 12, 13, 14, 15, 16, 18, 20, 22, 24, 26, 27, 28, 30, 32, 34, 36, 38, 40, 42

Item ID: **TGMMUNC**



**STEEL RULES**

- Stainless steel to avoid corrosion
- Hanging hole for easy storage

ITEM ID:	Length mm	Width x Thickness mm	Scale
STMM1150	150	20 x 0.8	mm / AF
ST200	200	20 x 0.8	mm / AF



**TT**  
SERIES Measuring Sets available

**MODULAR TOOL CONTROL SYSTEM**



**PAGE 89**



**DIAL GAUGE WITH MAGNETIC STAND**

- Aluminium dial indicator
- 57mm diameter dial with a turnable scale and two tolerance indexes
- An extra pointer indicates whole millimetres to make measurements simple
- The stand has central locking
- A strong magnet in the base to hold the stand in place when in use

Specifications:

Dial Indicator	10mm/0.01mm
Magnetic Force	Kg 80
Measuring range	mm 0-10
Reading	mm 0.01
Maximum height	mm 330
Base plate length	mm 55
Base plate width	mm 50
Base plate height	mm 60
Weight	kg 1.625

Item ID: **DGMM**

**FOAM**  
SERIES Measuring Sets available

**MODULAR TOOL CONTROL SYSTEM**



**PAGE 150**





**SQUARE BASE**

- Zinc plated for corrosion resistance
- Base square design enables the square to be sat on a work surface

ITEM ID:	Length mm	Blade Length mm
SQAB10070	100	70
SQAB150100	150	100
SQAB200130	200	130
SQAB300175	300	175

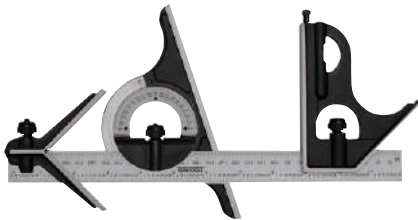

**COMBINATION SQUARE**

- For measuring and checking angles
- Graduated in mm and inches for universal use
- 300mm steel rule with a reversible protractor, adjustable angle ledge and centre head
- Angle ledge and protractor both include a spirit level

Specifications:

Protractor reading		0-180°
Steel rule length	mm	300
Square head length	mm	110
Centre head length	mm	63

Item ID: **SQAC300**



**ALUMINIUM STOCK TRY SQUARES**

- Stainless steel blade with an anodised aluminium stock
- Blade measures 1.5 x 45mm with the stock being 18mm wide
- Milled working surface with deep etched markings
- Highly resistant to wear

ITEM ID:	Blade Length mm	Accuracy	Weight g
SQAA200	200	±0.03	240
SQAA250	250	±0.03	275
SQAA300	100	±0.03	300



**SLIDING BEVEL**

- Check edges for consistency by sliding the edge over the material
- Duplicate angles for marking by setting the adjustable blade
- Straight and true stainless steel blade for accuracy
- Plastic stock for reduced weight and a better grip

ITEM ID:	Blade Length mm	Width mm	Accuracy	Weight g
AB200	200	25	25	100



### MEASURING TAPE METRIC/INCH

- mm and inches for international use
- ABS case for durability
- Rubberised grip for a more secure grip especially when wet or oily
- Tape lock and belt clip for secure storage when being used
- Power return tape for automatic rewinding
- Aligning hook for internal/external measurements
- Designed and manufactured to Cat II

ITEM ID:	Length m	Length ft	Width mm
MT03	3	10	13
MT05	5	16	19
MT08	8	26	25

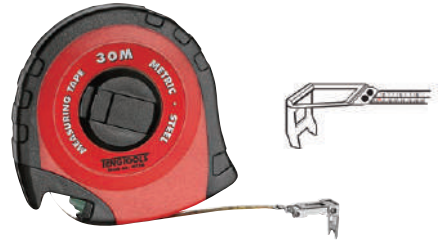

### MEASURING TAPE CLOSED CASE

- mm and inches for international use
- High impact plastic case for durability
- Rubberised grip for a more secure grip especially when wet or oily
- Tape lock and belt clip for secure storage when being used
- Steel roller cage prevents damage to the case
- Aligning hook for internal/external measurements
- Designed and manufactured to Cat II

ITEM ID:	Length m	Width mm
MT10	10	10
MT15	15	10



### MEASURING TAPE METRIC

- Graduated in mm only
- ABS case for durability
- Rubberised grip for a more secure grip especially when wet or oily
- Tape lock and belt clip for secure storage when being used
- Power return tape for automatic rewinding
- Aligning hook for internal/external measurements
- Designed and manufactured to Cat II

ITEM ID:	Length m	Width mm
MT03MM	3	13
MT05MM	5	19
MT08MM	8	25





**TORPEDO SPIRIT LEVEL**

- Magnetic aluminium "torpedo" spirit level
- 3 magnets on the underside help fix the level to ferrous work pieces
- One horizontal, one vertical and one 45° angled vials
- Crush proof, durable vials with high transparency for easy reading
- Highly resistant to ultra violet light and fluctuations in temperature
- Shock absorbent end protectors to reduce the risk of damage
- Temperature proof vial mountings to reduce the risk of distortion

ITEM ID:	Material	Length mm	Width mm	Height mm	Tolerance Normal	Weight g
SLT01	Aluminium	230	16	38	±1.0mm/m	190
SLT02	ABS Plastic	230	16	40	±1.5mm/m	160



**MAGNETIC ALUMINIUM SPIRIT LEVEL**

- Magnets on the underside help fix the level to ferrous work pieces
- Crush proof, durable vials with high transparency for easy reading
- Highly resistant to ultra violet light and fluctuations in temperature
- Shock absorbent end protectors to reduce the risk of damage
- Temperature proof vial mountings to reduce the risk of distortion

ITEM ID:	Length mm	Width mm	Height mm	Tolerance Normal	Tolerance Inverted	Weight g
SLM0300	300	24	50	±0.75mm/m	±0.75mm/m	240
SLM0400	400	24	50	±0.75mm/m	±0.75mm/m	310
SLM0600	600	24	50	±0.75mm/m	±0.75mm/m	450
SLM1000	1000	24	50	±0.75mm/m	±0.75mm/m	750
SLM1200	1200	24	50	±0.75mm/m	±0.75mm/m	900



The truck racing team TSport Bernau competes in the FIA European Truck Racing Championship, the highest level of European truck racing, requiring the highest level of quality on the tools.

# AUTO TOOLS

## Essentials for any garage

When working on motors and general servicing it is vital that you have the right tools ready when you are. Whether it is a spark plug socket or hose clamps you need tools that are great to work with and bring better results.







**90° HOOK TOOL**

- Ideal for retrieving lost or dropped items
- Ergonomically designed bi-material handle for easy use
- Hole in the handle for hanging or for use with a fall protection wire

Item ID: **MDH-S**



**GASKET SCRAPER**

- 22mm blade for the easy removal of gasket residue
- Ergonomically designed bi-material handle for easy use
- Hole in the handle for hanging or for use with a fall protection wire

Item ID: **MD-SCR**



**HOOK TOOL**

- Ideal for retrieving lost or dropped items
- Ergonomically designed bi-material handle for easy use
- Hole in the handle for hanging or for use with a fall protection wire

Item ID: **MDH-L**



**AWL STRAIGHT BI-MATERIAL GRIP**

- Straight awl with a round tip
- Ideal for piercing materials or for creating a start hole for screws
- Ergonomically designed bi-material handle for easy use
- Hole in the handle for hanging or for use with a fall protection wire
- Length: 164mm

Item ID: **MDA180**



**AWL ROUND TIP**

- Straight awl with a round tip
- Ideal for piercing materials or for creating a start hole for screws
- Ergonomically designed bi-material handle for easy use
- Hole in the handle for hanging or for use with a fall protection wire

Item ID: **MDA-R**



**90° HOOK TOOL BI-MATERIAL GRIP**

- Hook tool with a bent hook
- Ideal for retrieving lost or dropped items
- Ergonomically designed bi-material handle for easy use
- Hole in the handle for hanging or for use with a fall protection wire
- Length: 164mm

Item ID: **MDP90**



**TT**  
SERIES Auto Tool Sets available

**MODULAR TOOL CONTROL SYSTEM**



**PAGE 89**

**FOAM**  
SERIES Auto Tool Sets available

**MODULAR TOOL CONTROL SYSTEM**



**PAGE 150**



### 35° HOOK TOOL BI-MATERIAL GRIP

- Hook tool with a bent hook
- Ideal for retrieving lost or dropped items
- Ergonomically designed bi-material handle for easy use
- Hole in the handle for hanging or for use with a fall protection wire
- Length: 164mm

Item ID: **MDP35**



### 125° HOOK TOOL BI-MATERIAL GRIP

- Hook tool with a bent hook
- Ideal for retrieving lost or dropped items
- Ergonomically designed bi-material handle for easy use
- Hole in the handle for hanging or for use with a fall protection wire
- Length: 164mm

Item ID: **MDP125**



**TT**  
SERIES

Store x4 of these sets in a TCI Tray

**4**  
PIECES

### HOOK AND PICK SET 4 PIECE

- Interchangeable hooks and picks with a aluminium handle
- The handle has a built in magnet for retrieving lost ferrous parts
- Includes an awl as well as 3 different hooks with 45° and 90° tips
- Supplied in the unique TengTools TJ module
- Clear fold up lid to see which set you need to use
- Sliding catch to secure the set when not in use

Item ID: **TJ149**



### HOSE CLIP DRIVER 6MM/7MM

- Fits most commonly used worm drive hose clips such as Jubilee® hose clips
- Flexible shaft for easier access in confined spaces

ITEM ID:	Description
MD503N	Hose clip driver
MD503RK	Replacement 6/7mm socket



### HOSE CLIP DRIVER 7MM

- Fits most commonly used worm drive hose clips such as Jubilee® hose clips
- Flexible shaft for easier access in confined spaces

Item ID: **MD503NA**



### HOSE CLIP DRIVER 8MM

- Fits most commonly used worm drive hose clips such as Jubilee® hose clips
- Flexible shaft for easier access in confined spaces

Item ID: **MD503ND**





**HOSE CLAMP**

- Specially designed jaws prevent internal hoses from damage when clamping
- Light weight
- Easy to use
- Non conductive

ITEM ID:	Capacity mm	Capacity AF
AT080	6 to 19	¼" to ¾"
AT085	6 to 32	¼" to 1-¼"
AT090	19 to 57	¾" to 2-¼"



**SPARK PLUG BOOT PLIER**

- Designed to pull the spark plug boot from the spark plug without disturbing the HT lead
- Spring action for easier use particularly in confined spaces
- Plastic grip on the handle and the gripping area

ITEM ID:	Length mm	Weight g
SPBP20	250	297



**SPARK PLUG SOCKETS**

- Chrome vanadium
- Rubber insert holds the spark plug in place to prevent it dropping
- Satin finish for a better grip when handling the socket
- 6 point single hexagon socket for a better grip
- Ball bearing recess on the female end to grip the ratchet
- Supplied with a metal socket clip for use with a socket rail

ITEM ID:	Drive	Size	Width mm	Length mm	Thread Size	Weight g
M380039-C	3/8"	14mm	20	64	8	73
M380040-C	3/8"	16mm	21.4	64	10	100
M380041-C	3/8"	16mm Flexible	22	85	10	117
M380042-C	3/8"	18mm	23.5	70	12	130
M380046-C	3/8"	21mm	28	70	14	160
M380047-C	3/8"	21mm Flexible	28	91	14	169
M120040-C	1/2"	16mm	21.4	70	10	165
M120042-C	1/2"	18mm	24.2	70	12	165
M120046-C	1/2"	21mm	28	70	14	165



**TT SERIES** Auto Tool Sets available

**MODULAR TOOL CONTROL SYSTEM**



**PAGE 89**

**FOAM SERIES** Auto Tool Sets available

**MODULAR TOOL CONTROL SYSTEM**



**PAGE 150**

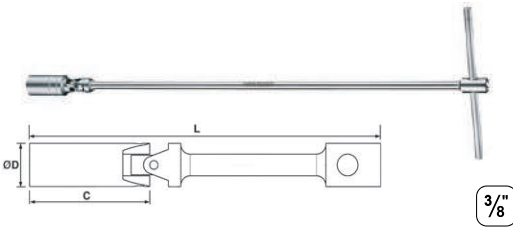

### 3/8" T-BAR SPARK PLUG SOCKET

- Extra long swivelling spark plug socket
- Long reach bar ideal for use in hard to reach places
- Universal joint and magnet at the socket
- Includes a T bar for fast pre-tightening and additional torque

ITEM ID:	Drive	Size mm	D mm	C mm	L mm	Weight g
TBUSP14	3/8"	14	18.8	60	520	380
TBUSP16	3/8"	16	21.8	60	520	400
TBUSP21	3/8"	21	27.8	60	520	440
T-HD01	200mm x 8mm spare bar for use with T-bar spark plug sockets					



### OIL FILTER REMOVAL TOOL STRAP TYPE

- Fully adjustable heavy duty strap
- Suitable for workshop tasks where round items need to be gripped
- Strong, drop forged steel handle for high leverage
- Reinforced, rubberised non stretch strap for a good grip
- Grips oil filters, etc up to 160mm diameter
- Overall length 230mm

ITEM ID:	Description
9123	Oil filter wrench
9123RK	Replacement Strap



### SPARK PLUG THREAD CLEANER

- Cleaning tool for spark plug threads in engine blocks

ITEM ID:	For Threads mm
TRC1012	10 x 1 & 12 x 1.25
TRC1418	14 x 1.25 & 18 x 1.5

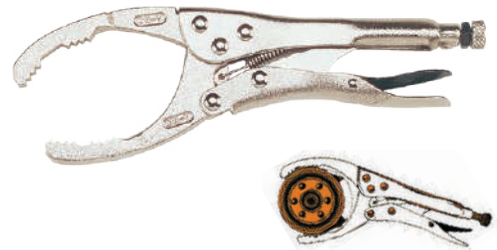

### OIL FILTER REMOVAL PLIER

- 53-118mm capacity to suit most oil filters
- Two stage grip areas on the jaws for added versatility
- Ideal for removing and installing objects of many shapes when a tight grip is required
- Chrome vanadium with drop forged jaws, heat treated and nickel plated

Item ID: **409**





1/2"

**1/2" OIL FILTER REMOVAL TOOL STRAP TYPE**

- Nylon webbing strap for gripping oil filters without causing damage
- 1/2" drive carbon steel adaptor for use with a ratchet or flex handle
- Grips oil filters up to 130mm diameter

ITEM ID:	Description	Drive	Capacity mm
9110	Oil filter wrench	1/2"	130
9110RK-1	Replacement Strap		



1/2"

**1/2" OIL FILTER REMOVAL TOOL CHAIN TYPE**

- Chain for gripping oil filters even when oily or damaged
- 1/2" drive carbon steel adaptor for use with a ratchet or flex handle
- Grips oil filters up to 120mm diameter

ITEM ID:	Description	Drive	Capacity mm
9120	Oil filter wrench	1/2"	120
9120RK-1	Replacement Chain		



1/2"

**1/2" HEAVY DUTY OIL FILTER REMOVAL TOOL**

- Maximum tensile strength of 1,850 kgf for the most stubborn of oil filters
- Chain for gripping oil filters even when oily or damaged
- 1/2" drive adaptor for use with a ratchet or 24mm spanner
- Grips oil filters up to 150mm diameter

Item ID: **9120HD**



**DRAIN PLUG**

- Double ended design to give 2 tools in 1
- For drain plugs on engines and gear boxes
- Use with a T bar or a 21mm socket or wrench

ITEM ID:	Size
DP0810	8mm hex x 10mm hex
DP0812	8mm square x 3/8" square
DP1012	5/16" hex x 3/8" hex
DP1112	11mm square x 12mm hex
DP1314	13mm square x 14mm hex
DP1716	17mm hex x 1/2" hex



**PISTON RING COMPRESSOR**

- Designed for holding piston rings in place when removing or replacing pistons
- 4 tightening bands suitable for cylinder diameters from 90 to 175mm
- Self locking ratchet pawl prevents premature release and allows a positive locking action
- Friction proof band edge gives a smooth and accurate action

Item ID: **AT020**





### ADJUSTABLE ENGINE CYLINDER HONING TOOL

- Adjustable to enable use on cylinders between 50 and 180mm diameter
- Spring tension adjustment to give a positive cutting action
- Suitable for use with air tools
- Supplied with 280 grit stones 100x10x8mm

ITEM ID:	Description
AT040	Engine cylinder honing tool
AT040-SM	Replacement 280 grit stones (3 Pieces) 100x10x8mm

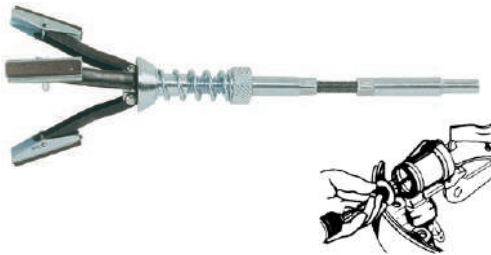

### ADJUSTABLE BRAKE CYLINDER HONING TOOL

- Adjustable to enable use on cylinders between 20 and 68mm diameter
- Spring tension adjustment to give a positive cutting action
- Suitable for use with air tools
- Supplied with 220 grit stones 28.5x5x2mm

ITEM ID:	Description
AT180	Brake cylinder honing tool
AT180-S	Replacement 220 grit stones (3 Pieces) 28.5x5x2mm



### BRAKE PIN PUNCH

- 5.5mm parallel pin punch for removing pins from brake disc pads
- Overall length 165mm to clear most pin holes

Item ID: **AT170**

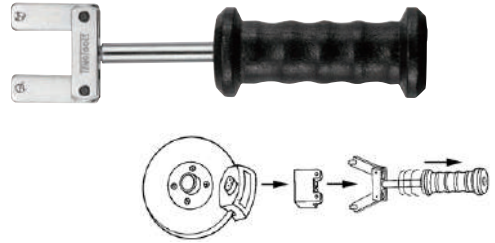

### BRAKE DISC PAD PULLER

- Sliding hammer function to help release brake pads from callipers
- Simply hook on to the disc pad with 5mm pins

Item ID: **AT330**



### BALL JOINT SEPERATOR

- Simple to use tool for separating ball joints

ITEM ID:	Opening mm	Adjustable Height mm
AT191	29	60
AT192	40	80
AT194	46	100





**SPECIALIST AUTOMOTIVE SOCKETS**

ITEM ID:	Drive	Size	Length mm	Application
920242	1/2"	1-5/16"	78	Wheel nuts
920248	1/2"	1-1/2"	78	Ball Joints
920624N	1/2"	24mm	78	Oil pressure switch
920627N	1/2"	27mm	78	Injectors
920628N	1/2"	28mm	78	Diesel Injectors
920629N	1/2"	29mm	78	Thermostat switch
920630N	1/2"	30mm	78	Hub nuts
920632N	1/2"	32mm	78	Hub nuts/drive shafts
920635N	1/2"	35mm	78	Hub nuts
920636N	1/2"	36mm	78	Hub nuts
940641-C	3/4"	41mm	58	Hub nuts
940258	3/4"	1-13/16"	58	Deep ball joint socket
120955-C	1/2"	TX55	100	Cylinder head bolts
AT350	1/2"	29mm	90	Oxygen sensor socket
AT355	3/8"	22mm	90	Oxygen sensor socket
AT360	1/2"	27mm	85	Injector socket
AT365	3/8"	7/8"	80	Vacuum switch socket
AT370	3/8"	11/16"	74	Oil sender socket
AT375	1/2"	7/8"	50	Heated oxygen sensor socket
AT380	3/8"	7/8"	30	Offset Oxygen sensor socket



**MAGNETIC RACK FOR TYRE TOOLS**

- Magnetic shelf for storing tyre tools
- Designed to take 4 sockets, torque wrench and an air wrench
- Can be easily fitted to any flat ferrous material surface
- Powerful magnets for secure fixing
- Ideal for using on the side of a tool cabinet

Item ID: **BDIS-TYR**



**TT**  
SERIES Auto Tool Sets available

**MODULAR TOOL CONTROL SYSTEM**



**PAGE 89**

**FOAM**  
SERIES Auto Tool Sets available

**MODULAR TOOL CONTROL SYSTEM**



**PAGE 150**



1/2"

### 1/2" WHEEL WRENCH

- 1/2" drive telescopic wheel wrench
- Extends from 14" (35cm) to 21" (55cm) making it ideal for keeping in the car
- Chrome vanadium steel for added strength and higher torque
- Supplied with a double ended impact sockets

ITEM ID:	Drive	Size mm	Weight g
1202	1/2"	17 x 19	900
1202A	1/2"	21 x 22	905

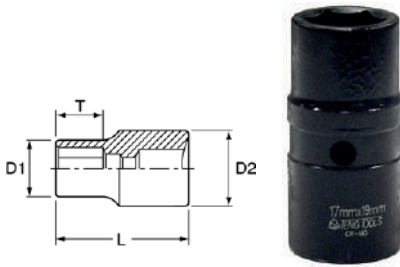

1/2" mm

### 1/2" DOUBLE ENDED IMPACT SOCKET METRIC

- Double ended 1/2" drive socket to give two sizes in one socket
- Chrome molybdenum for use with power tools
- Black phosphate finish for easy identification as an impact socket accessory

ITEM ID:	Size mm	L mm	D1 mm	D2 mm
9291719	17 / 19	58	26	28
9292122	21 / 22	58	30	32



3 Pieces 1/2" mm

### 1/2" DOUBLE ENDED IMPACT SOCKET SET

- Includes the most commonly used wheel nut socket sizes
- Chrome molybdenum for use with power tools
- Black phosphate finish for easy identification as an impact socket

3" Extension bar
Double Ended Wheel Nut Sockets:
17 x 19mm, 21 x 22mm

Item ID: **9203N1**

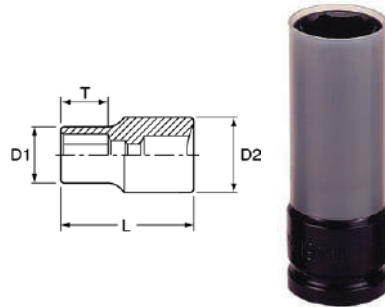

1/2" mm

### 1/2" IMPACT SOCKET WHEEL NUT

- Thin wall design for reaching in to recesses
- Protective sleeve for use on alloy wheels
- DIN standard design for use with a retaining pin and ring
- Chrome molybdenum for use with power tools
- Ring and pin fixing hole on the female end to secure the socket to the air gun

ITEM ID:	Size mm	L mm	T mm	D1 mm	D2 mm	Weight g
920517N	17	85	27	26	32	260
920519N	19	85	27	29	32	270
920521N	21	85	27	29	32	380





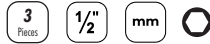

**1/2" IMPACT SOCKET WHEEL NUT SET**

- Thin wall design for reaching in to recesses
- Protective sleeve for use on alloy wheels
- DIN standard design for use with a retaining pin and ring
- Chrome molybdenum for use with power tools
- Ring and pin fixing hole on the female end to secure the socket to the air gun

Item ID: **9203N**



**TYRE LEVER**

- Traditional flat design for easy use
- Manufactured in medium carbon steel (HRC40 +/-2%) for high leverage

ITEM ID:	Size mm	Size AF
AT20512	304	12
AT20516	406	16
AT20520	508	20
AT20524	609	24



**BICYCLE KEY SET 11 PIECES**

- Designed for cyclists to carry easily
- Includes hexagon, TX and screwdriver keys together with a tyre lever and chain repair tool
- Chrome nickel finish
- Supplied in a handy fold up aluminium case

Ergonomically Designed Aluminium Holder, Tyre lever, Chain tool

Individual Keys:

	mm: 1 x 5.5
	PH2
	TX25 TX30
	mm: 4 5 6

Item ID: **1473**



**WING COVER**

- Full length magnetic strip to hold the cover in place on the vehicle bodywork
- Protects the paintwork from scratching when working on the vehicle
- Heavy duty red PVC with a cloth backing
- Includes the TengTools eyes logo in full colour
- Measures 40 x 107cm to provide a good area of protection

Item ID: **FC01**





**SUCTION LIFTER SINGLE**

- Handles open or close to engage or release the suction cups
- Ideal for lifting of items with flat, smooth surfaces such as glass
- Can also be used to pull out dents in bodywork panels

ITEM ID:	Suction Cups	Max Load Kg	Cup Diameter mm	Weight g
SL01	1	30	118	310



**SUCTION LIFTER TRIPLE**

- Handles open or close to engage or release the suction cups
- Ideal for lifting of items with flat, smooth surfaces such as glass
- Can also be used to pull out dents in bodywork panels

ITEM ID:	Suction Cups	Max Load Kg	Cup Diameter mm	Weight g
SL03	3	120	118	900



**SUCTION LIFTER DOUBLE**

- Handles open or close to engage or release the suction cups
- Ideal for lifting of items with flat, smooth surfaces such as glass
- Can also be used to pull out dents in bodywork panels

ITEM ID:	Suction Cups	Max Load Kg	Cup Diameter mm	Weight g
SL02	2	60	118	600



**DOLLY**

- For panel beating of sheet metal
- Use together with TengTools body working hammers

ITEM ID:	Shape	Length mm	Width mm	Height mm	Weight g
AT415	Curved	128	58	40	1100
AT420	Heel	80	60	30	900





**HAMMER BODY CROWN FACE STRAIGHT PEIN**

- Forged alloy steel head for durability
- Mirror polished face for a better contact with the metal
- Hickory handle for a traditional finish

ITEM ID:	Face Diameter mm	Weight g
HMBH01	32.5	400



**HAMMER BODY CROWN FACE POINT PICK**

- Forged alloy steel head for durability
- Mirror polished face for a better contact with the metal
- Hickory handle for a traditional finish

ITEM ID:	Face Diameter mm	Weight g
HMBH02	32.5	350



**HAMMER BODY CROWN FACE SQUARE MILLED**

- Forged alloy steel head for durability
- Mirror polished face for a better contact with the metal
- Hickory handle for a traditional finish

ITEM ID:	Face Diameter mm	Weight g
HMBH03	32.5	400



**DEAD BLOW HAMMER**

- Dead blow hammer
- Head filled with steel balls to prevent the hammer from bouncing
- Dead blow action particularly useful to reduce marking on the surface being hit

ITEM ID:	Face Diameter mm	Weight g
HMDH35	35	300
HMDH45	45	490
HMDH55	55	980
HMDH65	65	1365



**TT**  
SERIES

4

5  
PIECES

**BODYWORK HAMMER SET TT4 5 PIECES**

- A selection of hammers for use in the automotive body shop or metal working area
- Organised in a tool tray module size 4 (TT4)

Hammers:

Dead blow hammers with 35 and 55mm diameter heads, crown face hammers with straight pein, pick heads and square milled face

Item ID: **TTPSAD**



# SERVICE TOOLS

Designed to help you get the job done

This range of service tools have been developed for you to do what you do best everyday. Here you will find tools that will help you perform most general service tasks more efficiently. All TengTools service tools have been manufactured to exceed the demands of professional users.





**GREASE GUN**

- Lever style grease gun for use with 400g cartridges or up to 500cc bulk grease
- Grease is fed to the high pressure mechanism by fully opening the lever
- Supplied with pipe and hydraulic coupling (thread G(R) 1/8")

Item ID: **AT500**



**TWO/THREE ARM PULLER**

- Simple to use three legged puller for the fast removal of pulleys, wheels and bearings
- Designed for internal or external pulling with easily reversible legs
- The special yoke can also be used to convert from three legged to two legged pulling

ITEM ID:	Clamping Depth mm	Span Width mm	Weight g
SPA11	100	50-100	1080
SPA22	170	60-150	2600



**4" TWO/THREE ARM GEAR PULLER**

- Simple to use three legged puller for the fast removal of pulleys, wheels and bearings
- The special yoke can also be used to convert from three legged to two legged pulling

Item ID: **SP11**



**7" TWO/THREE ARM GEAR PULLER**

- Simple to use three legged puller for the fast removal of pulleys, wheels and bearings
- The special yoke can also be used to convert from three legged to two legged pulling

Item ID: **SP22**



**TT**  
SERIES Service Tool Sets available

**MODULAR TOOL CONTROL SYSTEM**



**PAGE 91**

**FOAM**  
SERIES Service Tool Sets available

**MODULAR TOOL CONTROL SYSTEM**



**PAGE 147**

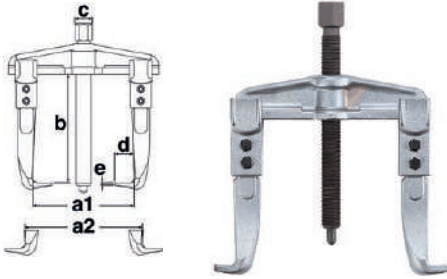

### TWO ARM UNIVERSAL PULLER

- Simple to use two legged puller for the fast removal of pulleys, wheels and bearings
- Designed for internal or external pulling with easily reversible legs
- Strong drop forged construction for strength and durability

ITEM ID:	a1 mm	a2 mm	b mm	Spindle Thread	Spindle			e mm	Weight g
					Length mm	c mm	d mm		
SP1410	90	130	100	M14 x 1.5	140	17	12	3.4	1100
SP1810	130	170	100	M14 x 1.5	140	17	12	3.4	1300
SP2215	160	220	150	M20 x 2.0	210	22	20	3.8	3200
SP2615	200	256	150	M20 x 2.0	210	22	20	3.8	3600
SP3320	250	325	200	M26 x 2.0	280	27	27	6.2	7800

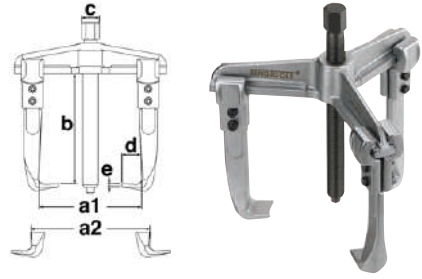

### THREE ARM UNIVERSAL PULLER

- Simple to use three legged puller for the fast removal of pulleys, wheels and bearings
- Designed for internal or external pulling with easily reversible legs
- Strong drop forged construction for strength and durability

ITEM ID:	a1 mm	a2 mm	b mm	Spindle Thread	Spindle			e mm	Weight g
					Length mm	c mm	d mm		
SP31410	90	140	100	M14 x 1.5	140	17	12	3.4	1400
SP31810	130	180	100	M14 x 1.5	140	17	12	3.4	1600
SP32215	160	220	150	M20 x 2.0	210	22	20	3.8	3500
SP32615	205	260	150	M20 x 2.0	210	22	20	3.8	4200
SP33320	252	330	200	M26 x 2.0	280	27	27	6.2	8800

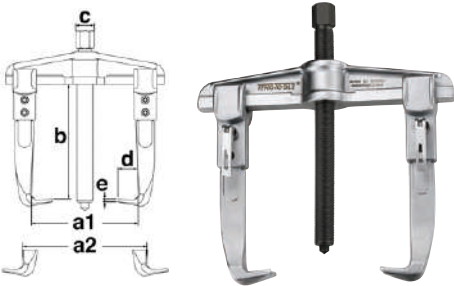

### TWO ARM QUICK ACTION PULLER

- Simple to use two legged puller for the fast removal of pulleys, wheels and bearings
- Quick lock action on the legs for fast adjustment
- Designed for internal or external pulling with easily reversible legs
- Strong drop forged construction for strength and durability

ITEM ID:	a1 mm	a2 mm	b mm	Spindle Thread	Spindle			e mm	Weight g
					Length mm	c mm	d mm		
SP1410Q	90	130	100	M14 x 1.5	140	17	12	3.4	1100
SP1810Q	130	170	100	M14 x 1.5	140	17	12	3.4	1200
SP2215Q	160	220	150	M20 x 2.0	210	22	20	3.8	3000
SP2615Q	200	256	150	M20 x 2.0	210	22	20	3.8	3400
SP3320Q	250	325	205	M26 x 2.0	280	27	27	6.2	7000

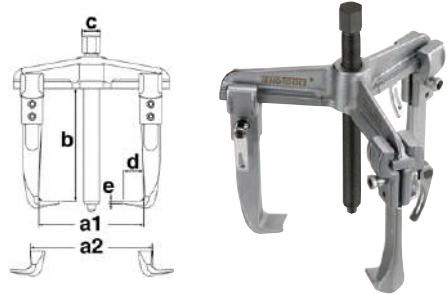

### THREE ARM QUICK ACTION PULLER

- Simple to use three legged puller for the fast removal of pulleys, wheels and bearings
- Quick lock action on the legs for fast adjustment
- Designed for internal or external pulling with easily reversible legs
- Strong drop forged construction for strength and durability

ITEM ID:	a1 mm	a2 mm	b mm	Spindle Thread	Spindle			e mm	Weight g
					Length mm	c mm	d mm		
SP31410Q	90	140	100	M14 x 1.5	140	17	12	3.4	1500
SP31810Q	130	180	100	M14 x 1.5	140	17	12	3.4	1600
SP32215Q	160	220	150	M20 x 2.0	210	22	20	3.8	3900
SP32615Q	205	260	150	M20 x 2.0	210	22	20	3.8	4200
SP33320Q	252	330	205	M26 x 2.0	280	27	27	6.2	8600





5  
Pieces

### PULLER SET WITH STAND

- A set of 5 two arm pullers complete with stand
- Strong, drop forged design for fast removal of pulleys, wheels and bearings
- Use as a set in a workshop giving a range of spreads from 90 to 250mm internal or 133 to 325mm external pullers
- Easily interchangeable between internal or external

2 Arm Pullers:

90/130mm spread, 130/170mm spread, 160/220mm spread,  
200/256mm spread, 250/325mm spread

Item ID: **DIS-SP05**



5  
Pieces

### PULLER SET QUICK TYPE WITH STAND

- A set of 5 two arm pullers complete with stand
- Strong, drop forged design for fast removal of pulleys, wheels and bearings
- Quick lock action on the legs for fast adjustment
- Use as a set in a workshop giving a range of spreads from 90 to 250mm internal or 133 to 325mm external pullers
- Easily interchangeable between internal or external

2 Arm Pullers:

90/133mm spread, 130/170mm spread, 158/209mm spread,  
200/256mm spread, 250/325mm spread

Item ID: **DIS-SP05Q**





### 1/4" SCREW EXTRACTOR

- For use with a 1/4" drive impact driver
- Spiral design for removing damaged screws
- A quick and easy way to remove broken screws, pipes, bolts and studs

ITEM ID:	Size	Length mm	Weight g
SE141	1	50	12
SE142	2	50	12
SE143	3	50	12



### SCREW EXTRACTOR

- Screw extractor
- Tapered designed for removing damaged screws
- Suitable for both clockwise and anti-clockwise threads
- Square shank and manufactured in CR-V 6150 steel hardened to HRC50-52

ITEM ID:	For Drill Hole mm	Weight g
SELO1S	3mm (1/8")	13
SELO2S	4mm (3/16")	22
SELO3S	5mm (15/64")	36
SELO4S	7mm (5/16")	52
SELO5S	9mm (3/8")	148



**TT**  
SERIES Service Tool Sets available

**MODULAR TOOL CONTROL SYSTEM**



**PAGE 91**



**5**  
Pieces

### SCREW EXTRACTOR SET 5 PIECES

- Tapered design for removing damage screws
- Suitable for both clockwise and anti-clockwise threads
- Square shank and manufactured in CR-V 6150 steel hardened to HRC50-52
- Use with drill sizes 3, 4, 5, 7 and 9mm
- Use with the TengTools tap handle (TAP-HDL)
- Supplied in the unique TengTools TJ module
- Clear fold up lid to see which set you need to use
- Sliding catch to secure the set when not in use
- Box equipped with a belt clip to keep tools in easy reach

Item ID: **TJSE05S**

**FOAM**  
SERIES Service Tool Sets available

**MODULAR TOOL CONTROL SYSTEM**



**PAGE 147**





5  
Pieces

**SCREW EXTRACTOR SET SPIRAL 5 PIECES**

- Spiral design for removing damaged screws
- A quick and easy way to remove broken screws, pipes, bolts and studs
- Use with drill sizes 7/64", 9/64", 5/32", 1/4" and 19/64"
- Use with the TengTools tap handle (TAP-HNDL)
- Supplied in a handy storage case

Item ID: **SE05**



2  
Pieces

**NUT SPLITTER SET**

- Simply tighten the thread to engage the blade and split stubborn nuts
- Capacities 5 to 20mm and 14 to 27mm

Item ID: **NS02**

**REPAIR KIT NUT SPLITTER NS02**

ITEM ID:	Description
NS02RKS	Small
NS02RKL	Large



**TT**  
SERIES Service Tool Sets available

**MODULAR TOOL CONTROL SYSTEM**



**PAGE 91**

**FOAM**  
SERIES Service Tool Sets available

**MODULAR TOOL CONTROL SYSTEM**



**PAGE 147**



1/2"

**1/2" STUD EXTRACTOR SOCKET**

- Designed for removing rounded or damaged bolts and studs
- Reversible enabling use on clockwise and anti-clockwise threads
- Use together with a 1/2" drive ratchet and accessories
- Chrome vanadium, satin finish

ITEM ID:	Drive	Size mm
ST12506-C	1/2"	6
ST12508-C	1/2"	8
ST12510-C	1/2"	10
ST12512-C	1/2"	12

**REPAIR KIT STUD EXTRACTORS ST12506 - ST12512**

ITEM ID:	For use with:
ST12506RK-1	ST12506-C
ST12508RK-1	ST12508-C
ST12510RK-1	ST12510-C
ST12512RK-1	ST12512-C



1/2"

**1/2" STUD EXTRACTOR ECCENTRIC**

- For inserting and extracting stud bolts
- One eccentric knurled contact wheel grips the stud against an internal fluting
- Suitable for use with stud bolts from 5.5 to 19mm diameter thread

Item ID: **2300**



3/8"

1/2"

**STUD EXTRACTORS**

- Designed for removing rounded or damaged bolt heads, nuts and studs
- Use together with a ratchet and accessories
- Chrome vanadium, satin finish

ITEM ID:	Drive	Size mm	Size AF	L mm	T mm	D1 mm	D2 mm	Weight g
ST38306	3/8"	6	1/4"	27	11	15.9	9.9	21
ST38308	3/8"	8	5/16"	27	11	15.9	12	23
ST38112	3/8"	-	3/8"	27	11	15.9	14.2	22
ST38310	3/8"	10	-	27	11	19	15.3	33
ST38311	3/8"	11	7/16"	27	11	19	15.6	33
ST38312	3/8"	12	-	27	11	19	17.4	33
ST38116	3/8"	-	1/2"	27	11	19	17.7	34
ST38313	3/8"	13	-	27	11	19	18.7	35
ST38314	3/8"	14	9/16"	27	11	22.2	20.7	50
ST38316	3/8"	16	5/8"	27	11	22.2	22.1	50
ST38317	3/8"	17	-	27	11	25.4	24.8	74
ST38122	3/8"	-	11/16"	27	11	25.4	24.8	74
ST12319	1/2"	19	3/4"	44.5	11	27	26.6	167
ST12321	1/2"	21	13/16"	44.5	12.5	32	28	199
ST12322	1/2"	22	7/8"	44.5	12.5	35	30.7	210
ST12324	1/2"	24	15/16"	44.5	12.5	36	32.4	210
ST12325	1/2"	25	1"	44.5	12.5	36	33.4	214





**PRY BAR ROLL HEEL TYPE**

- Roll or heel type design for opening and separating
- Tapered podger style handle for aligning holes prior to fixing
- Designed for use in construction such as scaffolding, pallet racking, shelving systems and metal panel erection

ITEM ID:	Size AF	Size mm
PB12	12"	300
PB16	16"	400
PB20	20"	500



**PRY BAR**

- Heavy duty with a power thru handle for use with a hammer
- Straight handle with a forked tip also suitable for use on nails, etc

ITEM ID:	Size AF	Size mm
PB12A	12"	300
PB18A	18"	450
PB22A	22"	550



**WRECKING BAR**

- Three functions in one handy tool
- Use as a lever for removing nails, etc.
- Ideal for use in confined spaces
- Sturdy steel construction (1045 medium carbon steel)

ITEM ID:	Overall Length
PF380	380mm (15")



**RATCHETING CRIMPING PLIER WITH 3 HEADS**

- Interchangeable ratchet crimping tool
- Automatic locking mechanism to ensure a consistent and correct crimping action
- Use on insulated, non insulated terminals and connectors
- Release function

Item ID: **CP52**

**REPLACEMENT DIES FOR CP52**

ITEM ID:	Insulated Terminals mm <sup>2</sup>	Non-Insulated Terminals mm <sup>2</sup>
CP04RK1	0.324 – 5.261	
CP04RK2		0.324 – 3.31
CP04RK3	0.3 – 8.0	



**RATCHETING CRIMPING PLIER**

- Compound ratchet action giving 30% extra strength
- Suitable for use with red, blue and yellow insulated terminals and connectors
- Automatic locking mechanism to ensure a consistent and correct crimping action
- Release function

Item ID: **CP58**

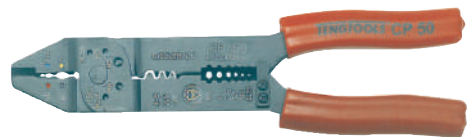

**CRIMPING PLIER**

- Use on insulated, non insulated terminals and connectors
- Wire stripping capacity from 0.75 to 6mm<sup>2</sup>
- Cutting function for M2.5 to M5 bolt sizes
- Plastic grips for more comfortable use

Item ID: **CP50**





**CRIMPING PLIER**

- Use on insulated, non insulated terminals and connectors
- Wire stripping capacity from 0.75 to 6mm<sup>2</sup>
- Cutting function for M2.5 to M5 bolt sizes
- Plastic grips for more comfortable use

Item ID: **CP51**



**WIRE STRIPPING PLIER GUN TYPE**

- Easy to use pistol grip action
- Hardened SK5 steel blade for fast accurate wire stripping
- Wire stripping capacity 24-10 AWG or 0.2 to 6mm<sup>2</sup>
- Built in wire cutter cuts up to 2mm diameter electrical wire

Item ID: **CP55**



**CRIMPING AND WIRE STRIPPING PLIER**

- Use on insulated, non insulated terminals and connectors
- Wire stripping capacity from 0.8 to 3.2mm<sup>2</sup>
- Cutting capacity 1.0mm copper cable
- Return spring for repeated use
- Locking action for easier storage

Item ID: **CP53**



**WIRE TWISTING PLIER**

- Normally used for wire locking nuts particularly in safety critical areas
- Slim nose design for optimum manoeuvrability
- Heavy duty locking jaws and return spring for durability and easier use
- Forged high carbon steel with polished jaws
- 1.0mm cutting capacity for stainless steel and inconel wire

ITEM ID:	Length		Weight
	AF	mm	g
AT605	6	150	250



**RATCHETING WIRE STRIPPING PLIER**

- Includes wire cutting and crimping functions
- Easily strips cable between 0.2 and 8.0mm<sup>2</sup>
- Suitable for crimping insulated and non insulated terminals and connectors
- Return spring action for easier repeated use

Item ID: **CP60**





### CABLE TIE GUN

- Ideal for repeated actions
- Works with plastic cable ties from 2.2 to 4.8mm width
- Adjustable tensile strength to avoid over tightening

Item ID: **CTG01**



### CIRCUIT TESTER

- Brass with steel probe and screw on cover
- Suitable for use between 6 and 24 volts
- 850mm cable with simple alligator grip
- Replacement bulb widely available (24 volt, 5 watt festoon type bulb)
- Simple to use to check if circuits are live and intact

Item ID: **9850**



### VOLTAGE TESTER

- Insulated voltage tester for use from 100 to 250 volts
- Overall length 145mm, blade length 70mm

Item ID: **MDV9855**



### DIGITAL MULTIMETER

- Ideal for automotive or industrial maintenance
- Extra large digital display with 16mm digits
- Fold out stand for easier use
- Use to measure voltage in DC or AC and DC current
- Includes a diode and continuity tester
- Measure temperature with the temperature probe
- Supplied with test leads
- Uses 2 AAA batteries (supplied)
- CAT I 600 volts, CAT II 300 volts, IEC61010

#### Specifications:

DC Voltage	Volts	250V
AC voltage	Volts	250V
Resistance	Ohms	200Ω - 2-20-200 KΩ -20MΩ
Temperature	°Celsius	-40 to +1,000

Item ID: **DM550**



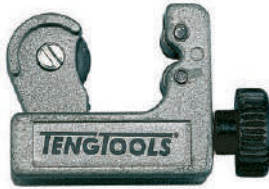

### PIPE CUTTER 3-22MM

- Designed for cutting copper and brass pipes
- Capacity 3 to 22mm (1/8" to 7/8")
- One cutting wheel and two rollers to give a consistent and straight cutting edge
- Ideal for use in confined spaces

Item ID: **TF22**



### PIPE CUTTER 6-76MM

- Heavy duty cutter with a light weight aluminium frame
- A retractable reamer is built in to the frame to debur rough edges
- Capacity 6 to 76mm (1/4" to 3") in thin and thick walled copper, brass and aluminium pipe
- Also suitable for cutting plastic pipes with a diameter of 16 to 76mm (5/8" to 3")
- One cutting wheel and two rollers to give a consistent and straight cutting edge

Item ID: **TF76**



### PIPE CUTTER 3-32MM

- Heavy duty cutter complete with a spare blade
- A retractable reamer is built in to the frame to debur rough edges
- Capacity 3 to 32mm (1/8" to 1-1/4")
- One cutting wheel and two rollers to give a consistent and straight cutting edge

Item ID: **TF30**

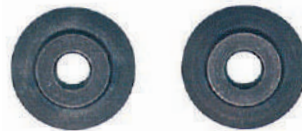

### SPARE PIPE CUTTER BLADES FOR TF76

- Spare pipe cutter cutting wheels

Item ID: **TF76RK**



### REPLACEMENT BLADES ROTATING PIPE CUTTER

- Spare pipe cutter cutting wheels

Item ID: **TF2230RK**



### PIPE CUTTER 42MM CAPACITY PE TUBING

- Cuts PEX or XLPE polythene tubing and other similar soft plastic piping up to 42mm diameter
- Gives a right angled and burr free cut
- A pistol grip style handle for more comfortable use
- A simple ratchet mechanism engages the cutter step by step to give more control over the cutting action

Item ID: **TFP01**





**REPLACEMENT BLADES PIPE CUTTER TFP01**

- Replacement cutting blade for the TengTools pipe cutter

Item ID: **TFP01RK**



**PIPE CUTTER 42MM CAPACITY PLASTIC**

- Cuts PEX or XLPE polythene tubing and other similar soft plastic piping up to 42mm diameter
- Gives a right angled and burr free cut
- Designed to give a more comfortable grip
- A simple ratchet mechanism engages the cutter step by step to give more control over the cutting action

Item ID: **TFP02**



**REPLACEMENT BLADES PIPE CUTTER TFP02**

- Replacement cutting blade for the TengTools pipe cutter

Item ID: **TFP02RK**



**ROTATING PIPE CUTTER**

- Rotating pipe cutter
- Ideal for cutting plastic, brass and copper pipes
- Simply rotate around the pipe to create a clean and straight cut

ITEM ID:	Pipe Diameter mm
TFA10	10
TFA12	12
TFA15	15
TFA22	22
TFA0252RK	5 spare wheels



**PIPE CUTTER CHAIN TYPE**

- For cutting thin walled pipes in stainless steel, copper, & pvc up to a thickness of 1.5mm
- Self locking with a non-pinch, one hand operation for easy use
- A locking nut on the adjustment knob can be used to preset the capacity
- 15 cutting wheels on the chain for an easy cutting action

Item ID: **TF300**



**REPLACEMENT PIPE CUTTER CHAIN**

- Replacement chain for the TengTools TF300 pipe cutter
- Fittings included

Item ID: **TF300RK**





### PIPE REAMER

- For deburring copper, aluminium and brass pipes
- Suitable for pipe diameters from 3 to 41mm
- Cutters at both ends for internal and external deburring

Item ID: **DBT41**



### ALUMINIUM PIPE REAMER

- For deburring pipes of all types
- Cutters at both ends for internal and external deburring

ITEM ID:	Pipe Diameter mm
DBT35	8 to 35mm
DBT54	10 to 54mm



### DEBURRING TOOL

- Suitable for deburring operations on pipes, holes, edges, etc
- HSS blade knives are swivel mounted to automatically adapt to the shape of the piece
- Supplied with 2 HSS knife blades

ITEM ID:	Description
DET01	Deburring tool
DET01RK	2 spare blades



### DEBURRING TOOL POCKET CLIP

- Suitable for deburring operations on pipes, holes, edges, etc
- HSS blade knives are swivel mounted to automatically adapt to the shape of the piece
- Handy pocket clip for added convenience

Item ID: **DET02**



### TELESCOPIC BASIN TAP WRENCH

- For reaching taps behind the bath or basin
- Spring loaded serrated jaw quickly grips on nuts and pipes
- Capacity 32 to 48mm
- Telescopic handle for even easier access in difficult to reach places
- Extends from 275 to 400mm

Item ID: **BWT406**



### CHAIN PIPE WRENCH

- Fully adjustable heavy duty chain
- Designed for mounting and unmounting pipes, etc.
- Suitable for tasks where round items need to be gripped
- Strong, drop forged steel handle for high leverage
- Grips pipes, etc up to 100mm diameter

Item ID: **9124**







**HAND RIVET GUN**

- For professional use in metal work, industry and construction
- Comfortable PVC grip

ITEM ID:	Aluminium	Steel	Stainless	Length	Weight
	mm	mm	mm		
HR12	2.4/3.2/4.0/4.8	2.4/3.2/4.0/4.8	2.4/3.2/4.0	250	560
HR12RK	Spare parts set				



**HAND RIVET GUN**

- For professional use in metal work, industry and construction
- Comfortable PVC grip

ITEM ID:	Aluminium	Steel	Stainless	Length	Weight
	mm	mm	mm		
HR30R	2.4/3.0/3.2/4.0/4.8	2.4/3.0/3.2/4.0/4.8	2.4/3.0/3.2/4.0/4.8	270	560
HR30RRK-1	Service Kit - Replacement nose pieces				
HR30RRK-2	Service Kit - Jaw pusher assembly				



**HAND RIVET GUN**

- For professional use in metal work, industry and construction
- Comfortable PVC grip

ITEM ID:	Aluminium	Steel	Length	Weight
	mm	mm	mm	g
HR14	2.4/3.0/3.2	2.4/3.0/3.2	270	627
HR14RK	Spare parts set			



**HAND RIVET GUN**

- For professional use in metal work, industry and construction
- Comfortable PVC grip

ITEM ID:	Aluminium	Steel	Length	Weight
	mm	mm	mm	g
HR01	2.4/3.2/4.0/4.8	2.4/3.2/4.0/4.8	250	560
HR01RK	Spare parts set			



**TT**  
SERIES Service Tool Sets available

**MODULAR TOOL CONTROL SYSTEM**



**PAGE 91**

**FOAM**  
SERIES Service Tool Sets available

**MODULAR TOOL CONTROL SYSTEM**



**PAGE 151**



### HAND RIVET GUN WITH SWIVEL HEAD

- Swivel head function to enable use at an angle or in confined spaces
- For professional use in metal work, industry and construction
- Comfortable PVC grip

ITEM ID:	Aluminium		Steel		Stainless	
	mm	mm	mm	mm	mm	mm
HR360R	2.4/3.0/3.2/ 4.0/4.8/5.0	2.4/3.0/ 3.2/4.0	2.4/3.0/3.2	2.4/3.0/3.2	295	712
HR12RK	Spare parts set					



### LONG HANDLED RIVET GUN

- For professional use in construction and industrial applications
- Two handed grips gives a much higher capacity
- 3 jaw sizes included
- Plastic container collects the spent mandrels
- Nose bushes for rivet diameter 3.2, 4.0, 4.8, 6.0 and 6.4mm

ITEM ID:	Description
HRLR01	Rivet Gun
HRLR01RK-2	Service Kit - Replacement nose pieces
HRLR01RK-3	Service Kit - Jaw pusher assembly



### LAZY TONGUE RIVET GUN

- For professional use in construction and industrial applications
- Lazy tongue design and function gives an increased riveting force
- Suitable for use in confined spaces
- 3 jaw sizes included
- Nose bushes for rivet diameter 3.2, 4.0, 4.8, 6.0 and 6.4mm

ITEM ID:	Description
HRLT01	Rivet Gun
HRLT01RK	Spare parts set

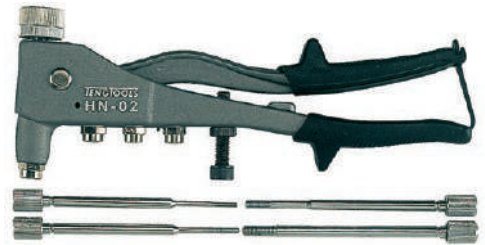

### NUTSERT GUN

- Aluminium alloy, forged steel upper handle with heat treated jaws
- Quick change, lockable threaded mandrels
- Mandrels for M3, M4, M5 and M6 included
- Comfortable PVC grip

ITEM ID:	Aluminium		Length mm	Weight g
	mm	mm		
HN02	M3 x 0.5, M4 x 0.7, M5 x 0.8, M6 x 1.0		250	800
HN02RK	Spare parts set			





**LONG HANDLED NUTSERT GUN**

- For professional use in construction and industrial applications
- Two handed grips gives a much higher capacity
- Draw rod compound action for quick loading and unloading
- Mandrels for M5, M6, M8 and M10 included
- Supplied in a metal case for storage and safe keeping

ITEM ID:	Aluminium mm	Length mm	Weight g
HRLN65N	M5, M6, M8, M10	530	1800
HRLN65NRK-1	Spare parts set		



**SCRIBER**

- Knurled handle to give a better grip when scribing or marking materials
- Handy pocket clip for storing while being used

ITEM ID:	Length mm	Diameter mm
SCR01	135	7



**SCRIBER WITH CARBIDE TIP**

- Hard tungsten carbide tip (K20 grade) for durability and clear marks when scribing
- Handy pocket clip for storing while being used

ITEM ID:	Length mm	Diameter mm
SCR02	150	6



**CLAW PICK UP TOOL**

- Excellent for reaching small items lost in hidden areas
- Flexible wire with non magnetic claws for minimal interference
- Press action to expand and contract the jaws to easily grip items
- Overall length 600mm

Item ID: **AT135**

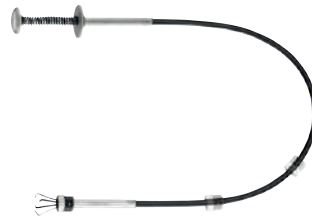

**MAGNETIC CLAW PICK UP TOOL**

- Excellent for reaching small items lost in hidden areas
- Flexible wire for minimal interference
- Magnetic collar to retrieve ferrous material items
- Press action to expand and contract the jaws to easily grip items
- Overall length 600mm

Item ID: **AT135M**





**TELESCOPIC MAGNIFYING GLASS**

- Adjustable head to help find items
- Ideal for finding lost nuts and bolts
- Extends to 960mm
- Glass diameter: 60mm
- Includes a pocket clip

Item ID: **581TMG**



**TELESCOPIC INSPECTION TOOL 3 IN 1**

- Combines a magnet with a mirror and a scribe
- Telescopic with a strong magnet extending to 57cm
- Fully adjustable polished mirror to help locate dropped items
- Screw cap to reveal a handy etching scribe
- Complete with pocket clip for easy storage while working

Item ID: **582MI**



**TELESCOPIC INSPECTION MIRROR**

- Adjustable head to help find items
- Ideal for finding lost nuts and bolts
- Extends to 960mm
- Mirror diameter 57mm
- Includes a pocket clip

Item ID: **581TMI**



**TELESCOPIC MAGNETIC PICK UP TOOL AND PEN**

- Combines a magnet with a pen for making notes
- Telescopic with a very strong magnet extending to 63cm
- Screw cap to reveal a handy pen
- Complete with pocket clip for easy storage while working

Item ID: **585MP**



**TELESCOPIC PICK UP TOOL 760MM**

- Extra strong magnet with a 4,500g lifting force
- Ideal for retrieving lost nuts and bolts
- Extends to 760mm
- Includes a pocket clip

Item ID: **581TMP**



**TELESCOPIC PICK UP TOOL 550MM**

- Strong magnet with a 200g lifting force
- Ideal for retrieving lost nuts and bolts
- Extends to 55cm

Item ID: **SD501**





**LED TORCH WITH POCKET CLIP**

- Satin, chrome plated brass body for a better grip
- Pocket clip for easy storage when working
- 25-30 lumen gives a bright light
- 45 degree light distribution illuminates a wider area
- Requires 2 AAA batteries (not included) typically giving 5.5 hours average usage

Item ID: **585**



**TORCH POCKET CLIP**

- LED light with a 200 lumens long lasting light
- Slide focus to adjust the beam width
- Beam illuminates up to 105 meters
- Shockproof body and IP 66 protection
- Pocket clip and pocket sized (132 mm length) for easy storage
- Requires 2 x AAA batteries (not included) for up to 13,5 hours usage

Item ID: **581N1**



**TORCH 147MM LENGTH**

- LED light with a 750 lumens long lasting light
- Slide focus to adjust the beam width
- Beam illuminates up to 178 meters
- Shockproof body and IP 66 protection
- Low battery indicator when battery strength falls below 15%
- Pocket sized (147 mm length) for easy storage
- Requires 3 x AAA batteries (not included) for up to 22 hours usage

Item ID: **582N1**



**TORCH 205MM LENGTH**

- LED light with a 1100 lumens long lasting light
- Slide focus to adjust the beam width
- Beam illuminates up to 239 meters
- Shockproof body and IP 66 protection
- Low battery indicator when battery strength falls below 15%
- Compact sized (205 mm length) for easy storage
- Requires 6 x AAA batteries (not included) for up to 38 hours usage

Item ID: **583N1**



**LED HEAD LAMP**

- Adjustable head band for a comfortable fit
- CREE technology to create a brighter, long lasting LED light
- Choice of two modes
- Requires 3 AA batteries (not included)
- Ideal for illuminating the work area while keeping the hands free

Specification:

Width	mm	50
Height	mm	50
Length	mm	55
Luminous flux	lumen	250
Weight	g	110

Item ID: **586A**





**LED HEAD LAMP**

- Adjustable head band for a comfortable fit
- CREE technology to create a brighter, long lasting LED light
- Choice of two modes
- Requires 3 AA batteries (not included)
- Ideal for illuminating the work area while keeping the hands free

Specification:		
Width	mm	50
Height	mm	50
Length	mm	55
Luminous flux	lumen	250
Weight	g	110

Item ID: **586C**



**MAGNETIC FLEXIBLE LED LIGHT**

- 3 LED diodes give a good strong light
- Fully flexible neck to give a wide range of adjustment
- Magnetic attachment for fixing quickly and simply with no drilling required
- Can be easily fitted to any flat ferrous material surface
- Requires 3 LR44 batteries (included)

ITEM ID:	Length mm	Diameter mm	Light Lumen	Power W	Weight g
587M	370	25	76.5	0.0009	67



**FLEXIBLE LIGHT WITH MAGNET**

- Flexible and adjustable to illuminate work areas
- Magnet on the end makes it ideal for seeing and then retrieving items from confined spaces
- Requires 2 AA batteries (not included)

Specification:		
Total length	mm	595
Flexible length	mm	400
Outside diameter	mm	10
Maximum magnetic force	g	750

Item ID: **586**



**MAGNIFYING GLASS WITH LED**

- Hand held magnifying glass
- 14 LED bulbs in a ring around the glass to illuminate the subject being viewed
- Requires 2 AAA batteries (not included)
- Mains adaptors available

ITEM ID:	Magnification	Diameter mm	LED Output	
			W	Lumens
587H	3	100	1.3	72

**ADAPTOR FOR MAGNIFYING GLASS WITH LED**

- Mains adaptor for 587H hand held magnifying glass

ITEM ID:	Plug Adaptor Region
587AE	Europe
587AU	UK
587AA	Aus & NZ





**KNEELING PAD 450X210MM**

- Handy kneeling pad made from hard wearing foam
- 30.5mm thick foam provides a good cushion area for the knees
- Ideal for use when working on a hard floor surface

Item ID: **KP01**



**KNEELING PAD 880X300MM**

- Handy kneeling pad made from hard wearing foam
- 30.5mm thick foam provides a good cushion area for the knees
- Ideal for use when working on a hard floor surface

Item ID: **KP02**



**KNEELING STORAGE PAD 480X320MM**

- Handy kneeling pad made from hard wearing foam
- 30.5mm thick foam provides a good cushion area for the knees
- Ideal for use when working on a hard floor surface

Item ID: **KP03**



**MECHANICS WORK CHAIR**

- Adjustable height to ensure a comfortable working position
- Padded seat with the TengTools logo
- Swivel castors to move around easily
- Handy storage shelf in the bottom of the stool keeping components close to hand

Specification:		
Seat cushion diameter	mm	360
Storage area	mm	310x310
Adjustable height	mm	420-500
Weight	kg	6.3

ITEM ID:	Description
TCA06	Mechanics Work Chair
TCA06RK	Spare Parts for TCA06



**MECHANICS CREEPER**

- Six sturdy wheels and a strong construction
- Padded cushion with the TengTools logo
- Recesses in the frame for the elbows make the creeper more comfortable to use

Specification:		
Width	mm	500
Height	mm	155
Length	mm	1,050
Weight	kg	8.5

Item ID: **TCA07**





**MAGNETIC BRACELET**

- An adjustable 340mm length bracelet
- Magnetic disc for holding metal items while working
- Ideal for use with nails, screws, nuts and bolts
- Holds items within easy reach while working

Item ID: **583M**



**MAGNETIC BITS TRAY**

- Stainless steel for longer life
- Plastic enclosed magnet to avoid damage to paintwork, etc
- Use for screws, nuts, washers, etc when disassembling
- Can be secured on it's side as well as upside down

Item ID: **580**



**LARGE MAGNETIC BITS TRAY**

- Stainless steel for longer life
- Plastic enclosed magnet to avoid damage to paintwork, etc
- Use for screws, nuts, washers, etc when disassembling
- Can be secured on it's side as well as upside down

Item ID: **580S**



**LARGE MAGNETIC BITS TRAY**

- Stainless steel for longer life
- Plastic enclosed magnet to avoid damage to paintwork, etc
- Use for screws, nuts, washers, etc when disassembling
- Can be secured on it's side as well as upside down

Item ID: **580A**



**PLASTIC MAGNETIC BOWL**

- Creates storage for small parts quickly and easily with no drilling required
- Can be easily fitted to any flat ferrous material surface
- Powerful magnet for secure fixing
- Ideal for using on the side of a roller cabinet

ITEM ID:	Diameter mm	Weight g
580Q	112	191
580R	150	400







**WELDING MAGNET**

- Ideal for holding sheet metal, pipes and tubes when welding
- Use to hold the pieces prior to and during welding
- Holds the material at 45° or 90° to ensure an exact angle
- Can be used on flat or round surfaces of ferrous materials

ITEM ID:	Holding Area mm	Max Width mm	Height mm	Magnetic Force kg
MH75	75	120	82	30
MH90	90	160	100	30



**QUICK CLAMP TOP LEVER**

- For internal or external clamping
- Fast action lever clamp with a unique design
- Powerful lever bar makes it easy to apply the correct clamping force
- Bottom mounted lever makes the clamp quick and comfortable to use
- Easy release button makes it equally quick and easy to unclamp
- Protective caps on the pressure plates to prevent damage
- Bi-material grip on the handle for a better grip

ITEM ID:	Clamping Force N	Span Width mm	Clamping Capacity mm	Weight g
CMQ150	1580	85	150	580
CMQ300	1580	85	300	680
CMQ450	1580	85	450	790
CMQ600	1580	85	600	890



**SCREW CLAMP**

- Reinforced malleable cast iron arms for increased strength
- High quality profiled rail with serrations for stability
- Protective caps on the pressure plates to prevent damage to the item being clamped
- Bi-material grip on the handle for a better grip

ITEM ID:	Clamping				
	Force N	Span Width mm	Throat Depth mm	Bar Dimension mm	Weight g
CMD12	1961	120	60	20.0 x 5.0	430
CMD16	2648	160	80	25.0 x 6.0	750
CMD20	3922	200	100	27.0 x 7.0	1120
CMD25	4903	250	120	29.0 x 9.0	1500
CMD30	4903	300	120	29.0 x 9.0	1590
CMD30A	5393	300	140	32.0 x 10.0	2050
CMD40	5393	400	140	32.0 x 10.0	2260
CMD40A	5393	400	175	32.0 x 10.0	2330
CMD50	4903	500	120	29.0 x 9.0	1940
CMD80	4903	800	120	29.0 x 9.0	2480



**QUICK CLAMP BOTTOM LEVER**

- For internal or external clamping
- Fast action lever clamp with a unique design
- Powerful lever bar makes it easy to apply the correct clamping force
- Top mounted lever makes the clamp quick and comfortable to use
- Easy release button makes it equally quick and easy to unclamp
- Protective caps on the pressure plates to prevent damage to the item being clamped
- Bi-material grip on the handle for a better grip

ITEM ID:	Clamping Force N	Span Width mm	Clamping Capacity mm	Weight g
CMQL150	1780	80	150	670
CMQL300	1780	80	300	780
CMQL450	1780	80	450	900





### F-TYPE CLAMP SWIVEL HANDLE

- 180° swivel handle for extra torque and fast action
- Swivelling pressure plate to grip even when tilted
- High quality construction for increased clamping strength
- Bi-material grip on the handle for a better grip

ITEM ID:	Clamping Force N	Span Width mm	Throat Depth mm	Weight g
CMF16T	160	80	16.5x7.5	570
CMF20T	200	100	19.5x9.5	1010
CMF25T	250	120	22x10.5	1330
CMF30T	300	140	25x12	1960
CMF35T	300	100	25x12	1140



### F-TYPE CLAMP FIXED HANDLE

- Fixed handle for fast action tightening and loosening
- Swivelling pressure plate to grip even when tilted
- High quality construction for increased clamping strength

ITEM ID:	Clamping Force N	Span Width mm	Throat Depth mm	Weight g
CMF16	160	80	16.5x7.5	480
CMF20	200	100	19.5x9.5	900
CMF25	250	120	22x10.5	1210
CMF30	300	140	25x12	1800
CMF35	300	120	25x12	1720



### RATCHET CLAMP

- Ratchet lever mechanism for high pressure, fast action clamping
- The ratchet action prevents over tightening and resists vibration
- Ergonomic design lever handle with non slip release lever

ITEM ID:	Clamping Force N	Span Width mm	Throat Depth mm	Bar Dimension mm	Weight g
CMFQ20	3432	200	100	19.5 x 9.5	1130
CMFQ25	3922	250	120	22.0 x 10.5	1500
CMFQ30	4903	300	140	25.0 x 12.0	2260
CMFQ40	5393	400	120	25.0 x 12.0	2400



### HINGE ADJUSTMENT WRENCH

- Specifically designed for adjusting exterior door and window hinges

ITEM ID:	Length mm	Diameter mm	Weight g
DHW1300	220	13	170
DHW1417	290	14 x 17	310
DHW1922	300	19 x 22	440





**BALL PEIN HAMMER**

- Double headed with a round pein and ball head
- Fibre glass shafted handle for reduced weight and durability
- A comfortable rubber type handle for a more secure grip

ITEM ID:	Head Weight oz	Overall Weight g	Head Diameter mm	Overall Length mm
HMBP12	12	550	28	280
HMBP16	16	600	30	320
HMBP24	24	1040	35	380
HMBP32	32	1280	39	380



**SOFT FACE HAMMER**

- Double headed with a nylon and a softer rubber type head
- Tubular steel shaft for extra strength
- Soft face heads to reduce marking on the surface being hit

ITEM ID:	Weight g	Length mm
HMSF	670	320
HMSFRK	Replacement Head	



**ENGINEERS HAMMER**

- Double headed with a square pein and a pointed head
- Fibre glass shaft with a comfortable, rubber type handle

ITEM ID:	Head Weight g	Overall Weight g	Head Diameter mm
HMEG300	300	420	300
HMEG500	500	650	320
HMEG800	800	1000	350



**LUMP HAMMER**

- Club style lump hammer
- 1.6 kilo (3-1/2lb) overall weight for heavy duty striking
- Ideal for use with cold chisels and other striking tools when extra force is needed
- Hanging hole which can be used together with a safety wire for added security when working at heights
- Steel handle for extra strength
- A comfortable, perforated rubber type handle for a more secure grip

ITEM ID:	Head Weight g	Overall Weight g	Head Diameter mm	Overall Length mm
HMS1250	1250	1609	43	296





### CARPENTERS CLAW HAMMER

- Double headed with a round pein
- Claw for removing nails, etc
- Hanging hole which can be used together with a safety wire
- Steel handle for extra strength when levering with the claw
- A comfortable, perforated rubber type handle

ITEM ID:	Head Weight oz	Overall Weight g	Head Diameter mm	Overall Length mm
HMCH08A	8	394	21.6	290
HMCH13A	13	552	27	335
HMCH16A	16	700	27	312
HMCH20A	20	765	30	340



### CARPENTERS MAGNETIC CLAW HAMMER

- Double headed with a round pein and a claw for removing nails, etc
- Magnetic nail holder in the head for positioning nails on the first strike
- Hanging hole which can be used together with a safety wire
- Steel handle for extra strength when levering with the claw
- A comfortable, perforated rubber type handle

ITEM ID:	Head Weight oz	Overall Weight g	Head Diameter mm	Overall Length mm
HMCH16M	16	678	27.5	341



### CARPENTERS SHOCK ABSORBENT CLAW HAMMER

- Double headed with a round pein and a claw for removing nails, etc
- Hanging hole which can be used together with a safety wire
- One piece forged steel handle for extra strength
- Shock absorbent grip to reduce impact vibration when striking

ITEM ID:	Head Weight oz	Overall Weight g	Head Diameter mm	Overall Length mm
HMCHM16	16	723	29	333





**PARALLEL PIN PUNCH**

- Special tempered steel construction with hardened point for longer life
- Overall length 150mm with hexagon grip and rounded shaft area

ITEM ID:	Size mm	Length mm
PP03	3	150
PP04	4	150
PP05	5	150
PP06	6	150
PP07	7	150
PP08	8	150



**CENTRE PUNCH**

- Special tempered steel construction with hardened point for longer life
- Strike with a hammer for marking hard materials such as metal, etc.

ITEM ID:	Size mm	Length mm
CP04	4	150
CP05	5	150
CP08	8	150



**AUTOMATIC CENTRE PUNCH**

- Spring is compressed and then released when the tip is pushed down
- Use to create an indentation in the material to be marked
- 1mm diameter tip
- Handy pocket clip for storing while being used

Item ID: **SCP01**



**FLAT COLD CHISEL**

- Special tempered steel construction with hardened cutting edge for longer life
- For shaping, cutting and chipping hard materials such as metal, stone and concrete

ITEM ID:	Size mm	Length mm
CC150F	18	150
CC200F	25	200
CC250F	25	250
CC240F	26	240



**CHISEL HAND PROTECTION GRIP**

- Heavy moulded impact absorbing hand grip
- For protection when striking with a hammer
- Protective plate improves safety against accidental impact
- Ergonomic design to help avoid injuries to the hand
- For use with TengTools 200, 240 and 250mm cold chisels

ITEM ID:	Length mm	Width mm	Weight g
PCCAP	120	56	45

**TT SERIES** Service Tool Sets available

**MODULAR TOOL CONTROL SYSTEM**

**PAGE 91**



**FOAM SERIES** Service Tool Sets available

**MODULAR TOOL CONTROL SYSTEM**

**PAGE 151**





10  
Pieces

### PUNCH & CHISEL SET WALL RACK 10 PIECES

- Flat cold chisel made from chrome molybdenum
- Pin punches made from chrome molybdenum
- Supplied with a wall rack for fixing to the wall or a workbench

Punches:		
Centre	Length: 150 mm	5 mm
Parallel	Length: 150 mm	3, 4, 5, 6, 7, 8 mm
Flat cold chisels::		
150 mm		Width: 19 mm
200 mm		Width: 25 mm
250 mm		Width: 25 mm

Item ID: **WRPC10**



6  
Pieces

### PARALLEL PIN PUNCH SET 6 PIECES

- Special tempered steel construction with hardened point for longer life
- Overall length 150mm with hexagon grip and rounded shaft area
- Supplied with a handy storage holder

Punches:		
Parallel	Length: 150 mm	3, 4, 5, 6, 7, 8 mm

Item ID: **PPS06**



5  
Pieces

### PUNSCH & CHISEL SET 5 PIECES

- Includes a cold chisel, centre punch and 3 parallel pin punches
- Special tempered steel construction with hardened cutting edges and points for longer life
- Supplied in a handy storage holder

Punches:		
Centre	Length: 150 mm	5 mm
Parallel	Length: 150 mm	3, 4, 5 mm
Flat cold chisels:		
150 mm		Width: 19 mm

Item ID: **PCX05**



### SPRIAL WIRE PLASTIC COATED

- For securing tools when working at a height
- Locking wire with a spring clip hook at each end plus a fixing wire
- Plastic covered (3mm diameter) stainless steel spiral wire (1mm diameter) with a maximum load of 3 kilos
- Stretches from 430mm to 1.6 meters

Item ID: **SSH01**





**ELASTIC STRAP**

- For securing tools when working at a height

Item ID: SSH02



**ELASTIC STRAP**

- For securing tools when working at a height

Item ID: SSH03



**ELASTIC STRAP**

- For securing tools when working at a height

Item ID: SSH04

Lens Colour	CE scale No.	Visible Light 380-780nm	General Features
Clear	2-1.2 2C-1.2	90% (UV385)	<ul style="list-style-type: none"> <li>◇ General purpose that provides maximum visibility.</li> <li>◇ Indoor lens, good for mechanical work, or dusk, dawn and night time activities.</li> <li>◇ For shooting indoors when no contrast is needed. An excellent safety lens while hand loading.</li> </ul>
Amber	2-1.2	80% (UV385)	<ul style="list-style-type: none"> <li>◇ Maximum enhancement of contrast in low light environments i.e. warehouse.</li> <li>◇ Blocks out 87% of blue light with unparalleled level of detail definition &amp; colour recognition.</li> <li>◇ Offers brighter view in early morning or late evening, on cloudy, foggy, or hazy days.</li> <li>◇ Suitable for night shift workers, surface inspection and mechanical work.</li> <li>◇ Recommended for shooting and indoor racquet sports.</li> </ul>
Smoke	5-2.5	18% (UV385)	<ul style="list-style-type: none"> <li>◇ Transmits all colours at the same level.</li> <li>◇ Protects eyes from excessive glare and high levels of hazardous visible light and ultraviolet radiation without distorting colour perception.</li> <li>◇ Ideal for outdoors, for use on bright days &amp; bright sunlight, but does not enhance target.</li> <li>◇ General purpose safety lens / the most popular tinted lens.</li> </ul>



**SAFETY GLASSES**

- Optically neutral lenses with anti-fog and anti-scratch resistance (HC/AF)
- Shaped to give a large panorama view and integrated side protection
- Suitable for work wear or for visitor protection wear
- In accordance with EN166 class 1FT

ITEM ID:	Lens	Scratch Resistant	Anti Fog
SG960	Clear	Y	Y

Item ID: SG960





Smoke

**SAFETY GLASSES**

- Optically neutral lenses with anti-fog and anti-scratch resistance (HC/AF)
- Shaped to give a large panorama view and integrated side protection
- Suitable for work wear or for visitor protection wear
- In accordance with EN166 class 1FT

ITEM ID:	Lens	Scratch Resistant	Anti Fog
SG960G	Grey/Smoke	Y	Y

Item ID: **SG960G**



Clear

**SAFETY GLASSES**

- Optically neutral lenses with anti-fog and anti-scratch resistance (HC/AF)
- Shaped to give a large panorama view and integrated side protection
- Suitable for work wear or for visitor protection wear
- In accordance with EN166 class 1FT

ITEM ID:	Lens	Scratch Resistant	Anti Fog
SG960A	Clear	Y	-

Item ID: **SG960A**



Amber

**SAFETY GLASSES**

- Optically neutral lenses with anti-fog and anti-scratch resistance (HC/AF)
- Shaped to give a large panorama view and integrated side protection
- Suitable for work wear or for visitor protection wear
- In accordance with EN166 class 1FT

ITEM ID:	Lens	Scratch Resistant	Anti Fog
SG960Y	Amber	Y	Y

Item ID: **SG960Y**



Clear

**SAFETY GLASSES SPORT STYLE**

- Sports inspired design for a more stylish pair of protective glasses
- Optically neutral lenses with anti-fog and anti-scratch resistance (HC/AF)
- Soft bridge nose and side pieces for a more comfortable fit
- Clear polycarbonate lenses
- Shaped to give a large panorama view and integrated side protection
- Suitable for work wear or for visitor protection wear
- In accordance with EN166 class 1FT

ITEM ID:	Lens	Scratch Resistant	Anti Fog
SG713	Clear	Y	Y

Item ID: **SG713**







**SAFETY GLASSES SPORT STYLE**

- Sports inspired design for a more stylish pair of protective glasses
- Optically neutral lenses with anti-fog and anti-scratch resistance (HC/AF)
- Soft bridge nose and side pieces for a more comfortable fit
- Clear polycarbonate lenses
- Shaped to give a large panorama view and integrated side protection
- Suitable for work wear or for visitor protection wear
- In accordance with EN166 class 1FT

ITEM ID:	Lens	Scratch Resistant	Anti Fog
SG713G	Grey/Smoke	Y	Y

Item ID: **SG713G**



**SUN GLASSES**

- Straight arms
- Tinted glasses to protect against sunlight and bright lights
- Light and comfortable work wear glasses that give stylish protection
- Impact resistant with high optical clarity
- Conform to EN166, AS/NZS1067

ITEM ID:	Style	Arm Type
P-SG01	Red Frames	Straight

Item ID: **P-SG01**



**SUN GLASSES**

- Straight arms
- Tinted glasses to protect against sunlight and bright lights
- Light and comfortable work wear glasses that give stylish protection
- Impact resistant with high optical clarity
- Conform to EN166, AS/NZS1067

ITEM ID:	Style	Arm Type
P-SG02	Black/Grey Frames	Straight

Item ID: **P-SG02**



**SUN GLASSES**

- Straight arms
- Tinted glasses to protect against sunlight and bright lights
- Light and comfortable work wear glasses that give stylish protection
- Impact resistant with high optical clarity
- Conform to EN166, AS/NZS1067

ITEM ID:	Style	Arm Type
P-SG03	Black Frames	Curved

Item ID: **P-SG03**

# AIR TOOLS

## Essential for any workshop

Air is a powerful and versatile resource that can help you get the job done quickly! If you need to cut through steel or machine-tighten a bolt, you will need a certain amount of torque. Choosing a tool for its convenience or cost really won't do any good if it isn't strong enough to get the job done. This range of air tools pack a real punch and have been developed to exceed the demands of a professional auto workshop.

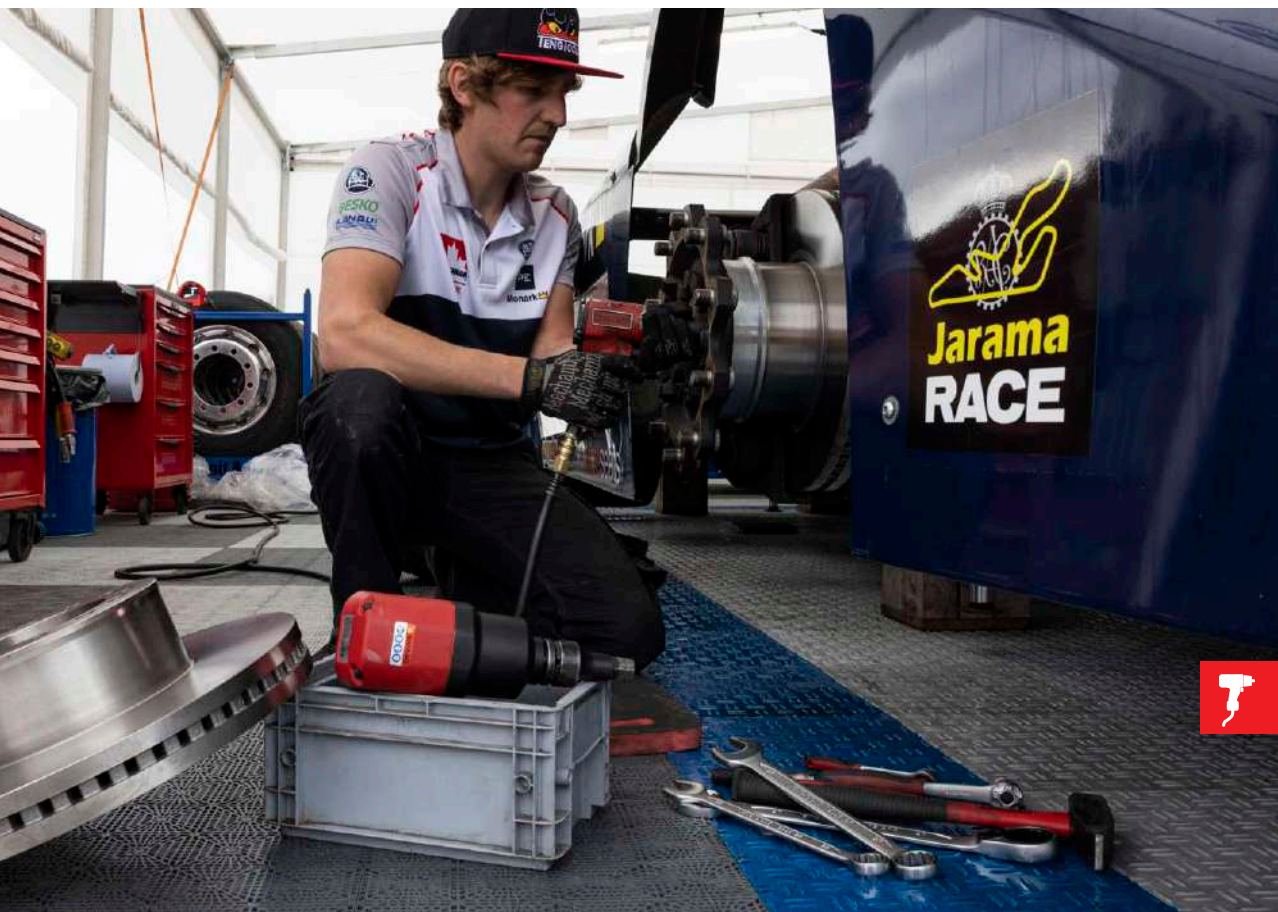



3/8"

**3/8" AIR RATCHET**

- Reversible for tightening or loosening
- Designed for working in confined areas
- High torque forward and reverse action
- Simple single clutch operation for greater control
- Metal "squeeze action" trigger for easier use
- Handle design insulates against cold air and vibration

SPECIFICATION:		
Square drive	inch	3/8"
Bolt capacity	mm	M10
Free speed	rpm	220
Forward/reverse torque	Nm	41
Forward/reverse torque	ft-lb	30
Sound level *	dB	88
Vibration **	m/s <sup>2</sup>	10
Minimum hose size	inch	3/8"
Air inlet	inch	1/4"
Air consumption at 100% int.	l/min	90.6
Air consumption at 100% int.	cfm	3.2
Air consumption at 15% int.	l/min	14
Air consumption at 15% int.	cfm	0.5
Length	mm	173.9
Weight	kg	0.6

\* A weighted sound pressure level at work station in accordance with EN ISO 15744

\*\* Vibration value according to EN ISO 28927-2

Item ID: **ARRM38**



**TT**  
SERIES

Air Tool Sets available

**MODULAR TOOL CONTROL SYSTEM**



**PAGE 95**



1/2"

**MINI AIR IMPACT WRENCH**

- Three forward steps up to 680Nm
- Compact and lightweight for use in confined spaces
- Extra high torque capacity for the size and weight
- Jumbo clutch mechanism
- Reversible for tightening or loosening
- Forward/reverse button for one handed operation
- Extra lightweight composite housing
- Sound absorbent housing for noise reduction

SPECIFICATION:		
Square drive	inch	1/2"
Bolt capacity	mm	M16
Free speed	rpm	8,000
Max torque (3 steps)	Nm	285/380/680
Max torque (3 steps)	ft-lb	210/280/501
Max reverse torque	Nm	770
Max reverse torque	ft-lb	568
Hammer mechanism	type	Jumbo hammer
Sound level *	dB	102
Vibration **	m/s <sup>2</sup>	7.5
Minimum hose size	inch	3/8"
Air inlet	inch	1/4"
Air consumption at 100% int.	l/min	121
Air consumption at 100% int.	cfm	4.23
Air consumption at 15% int.	l/min	18
Air consumption at 15% int.	cfm	0.6
Length	mm	113
Weight	kg	1.3

\* A weighted sound pressure level at work station in accordance with EN ISO 15744

\*\* Vibration value according to EN ISO 28927-2

Item ID: **ARWM12M**



3/8"

**3/8" DRIVE AIR IMPACT WRENCH**

- Three forward steps up to 465Nm
- Reversible for tightening or loosening
- Forward/reverse button for one handed operation
- High torque action
- Hard wearing, lightweight aluminium housing
- Twin hammer mechanism for increased torque and reduced vibration
- Handle design insulates against cold air and vibration

SPECIFICATION:		
Square drive	inch	3/8"
Bolt capacity	mm	M13
Free speed	rpm	9,000
Max torque (3 steps)	Nm	115/285/465
Max torque (3 steps)	ft-lb	85/210/342
Max reverse torque	Nm	490
Max reverse torque	ft-lb	361
Hammer mechanism	type	Twin hammer
Sound level *	dB	95.4
Vibration **	m/s <sup>2</sup>	4.96
Minimum hose size	inch	3/8"
Air inlet	inch	1/4"
Air consumption at 100% int.	l/min	105
Air consumption at 100% int.	cfm	3.7
Air consumption at 15% int.	l/min	16
Air consumption at 15% int.	cfm	0.6
Length	mm	159.4
Weight	kg	1.5

\* A weighted sound pressure level at work station in accordance with EN ISO 15744

\*\* Vibration value according to EN ISO 28927-2

Item ID: **ARWM38**



1/2"

**1/2" DRIVE AIR IMPACT WRENCH**

- Three forward steps up to 465Nm
- Reversible for tightening or loosening
- Forward/reverse button for one handed operation
- High torque action
- Hard wearing, lightweight aluminium housing
- Twin hammer mechanism for increased torque and reduced vibration
- Handle design insulates against cold air and vibration

SPECIFICATION:		
Square drive	inch	1/2"
Bolt capacity	mm	M16
Free speed	rpm	6,800
Max torque (3 steps)	Nm	385/530/930
Max torque (3 steps)	ft-lb	285/390/685
Max reverse torque	Nm	950
Max reverse torque	ft-lb	700
Hammer mechanism	type	Twin hammer
Sound level *	dB	92.5
Vibration **	m/s <sup>2</sup>	22.45
Minimum hose size	inch	3/8"
Air inlet	inch	1/4"
Air consumption at 100% int.	l/min	162
Air consumption at 100% int.	cfm	5.3
Air consumption at 15% int.	l/min	24.3
Air consumption at 15% int.	cfm	0.8
Length	mm	183.1
Weight	kg	2.5

\* A weighted sound pressure level at work station in accordance with EN ISO 15744

\*\* Vibration value according to EN ISO 28927-2

Item ID: **ARWM12**





3/4"

**3/4" AIR IMPACT WRENCH**

- Three forward steps up to 465Nm
- Reversible for tightening or loosening
- Forward/reverse button for one handed operation
- High torque action
- Hard wearing, lightweight aluminium housing
- Twin hammer mechanism for increased torque and reduced vibration
- Handle design insulates against cold air and vibration

SPECIFICATION:		
Square drive	inch	3/4"
Bolt capacity	mm	M32
Free speed	rpm	5,000
Max torque (3 steps)	Nm	1,084/1,300/1,790
Max torque (3 steps)	ft-lb	800/960/1,320
Max reverse torque	Nm	1,830
Max reverse torque	ft-lb	1,349
Hammer mechanism	type	Twin hammer
Sound level *	dB	95.1
Vibration **	m/s <sup>2</sup>	11.88
Minimum hose size	inch	1/2"
Air inlet	inch	3/8"
Air consumption at 100% int.	l/min	181
Air consumption at 100% int.	cfm	6.4
Air consumption at 15% int.	l/min	27.2
Air consumption at 15% int.	cfm	1
Length	mm	218.8
Weight	kg	3.9

\* A weighted sound pressure level at work station in accordance with EN ISO 15744

\*\* Vibration value according to EN ISO 28927-2

Item ID: **ARWM34**



3/8"

**3/8" DRIVE COMPOSITE AIR IMPACT WRENCH**

- Three forward steps up to 450Nm
- Reversible for tightening or loosening
- Forward/reverse button for one handed operation
- High torque action
- Extra lightweight composite housing
- Sound absorbent housing for noise reduction
- Twin hammer mechanism for increased torque and reduced vibration
- Handle design insulates against cold air and vibration

SPECIFICATION:		
Square drive	inch	3/8"
Bolt capacity	mm	M13
Free speed	rpm	9,000
Max torque (3 steps)	Nm	163/244/450
Max torque (3 steps)	ft-lb	120/180/331
Max reverse torque	Nm	470
Max reverse torque	ft-lb	346
Hammer mechanism	type	Twin hammer
Sound level *	dB	94
Vibration **	m/s <sup>2</sup>	3.8
Minimum hose size	inch	3/8"
Air inlet	inch	1/4"
Air consumption at 100% int.	l/min	128
Air consumption at 100% int.	cfm	4.5
Air consumption at 15% int.	l/min	19
Air consumption at 15% int.	cfm	0.7
Length	mm	161
Weight	kg	1.3

\* A weighted sound pressure level at work station in accordance with EN ISO 15744

\*\* Vibration value according to EN ISO 28927-2

Item ID: **ARWC38**





1/2"

**1/2" DRIVE COMPOSITE AIR IMPACT WRENCH**

- Three forward steps up to 450Nm
- Reversible for tightening or loosening
- Forward/reverse button for one handed operation
- High torque action
- Extra lightweight composite housing
- Sound absorbent housing for noise reduction
- Twin hammer mechanism for increased torque and reduced vibration
- Handle design insulates against cold air and vibration

## SPECIFICATION:

Square drive	inch	1/2"
Bolt capacity	mm	M16
Free speed	rpm	6,800
Max torque (3 steps)	Nm	258/461/930
Max torque (3 steps)	ft-lb	190/340/685
Max reverse torque	Nm	960
Max reverse torque	ft-lb	708
Hammer mechanism	type	Twin hammer
Sound level *	dB	96
Vibration **	m/s <sup>2</sup>	3.6
Minimum hose size	inch	3/8"
Air inlet	inch	1/4"
Air consumption at 100% int.	l/min	144
Air consumption at 100% int.	cfm	5.1
Air consumption at 15% int.	l/min	22
Air consumption at 15% int.	cfm	0.8
Length	mm	186
Weight	kg	2

\* A weighted sound pressure level at work station in accordance with EN ISO 15744

\*\* Vibration value according to EN ISO 28927-2

Item ID: **ARWC12**

3/4"

**3/4" DRIVE COMPOSITE AIR IMPACT WRENCH**

- Three forward steps up to 450Nm
- Reversible for tightening or loosening
- Forward/reverse button for one handed operation
- High torque action
- Extra lightweight composite housing
- Sound absorbent housing for noise reduction
- Twin hammer mechanism for increased torque and reduced vibration
- Handle design insulates against cold air and vibration

## SPECIFICATION:

Square drive	inch	3/4"
Bolt capacity	mm	M32
Free speed	rpm	6,000
Max torque (3 steps)	Nm	1,084/1,300/1,790
Max torque (3 steps)	ft-lb	800/960/1,320
Max reverse torque	Nm	1,830
Max reverse torque	ft-lb	1,349
Hammer mechanism	type	Twin hammer
Sound level *	dB	100
Vibration **	m/s <sup>2</sup>	19
Minimum hose size	inch	1/2"
Air inlet	inch	3/8"
Air consumption at 100% int.	l/min	195
Air consumption at 100% int.	cfm	6.9
Air consumption at 15% int.	l/min	29
Air consumption at 15% int.	cfm	1
Length	mm	218.8
Weight	kg	3.5

\* A weighted sound pressure level at work station in accordance with EN ISO 15744

\*\* Vibration value according to EN ISO 28927-2

Item ID: **ARWC34**

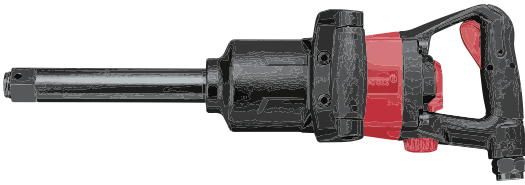

1"

**STRAIGHT AIR IMPACT WRENCH**

- Four forward steps up to 2,712Nm
- Extra lightweight composite housing
- Straight design with long anvil
- Reversible for tightening or loosening
- Forward/reverse button for one handed operation
- High torque action
- Sound absorbent housing for noise reduction
- Twin hammer mechanism for increased torque and reduced vibration
- Handle design insulates against cold air and vibration

SPECIFICATION:		
Square drive	inch	1"
Bolt capacity	mm	M36
Free speed	rpm	5,500
Max torque (4 steps)	Nm	976/1,300/1,735/2,712
Max torque (4 steps)	ft-lb	720/960/1,280/2,000
Max reverse torque	Nm	2,730
Max reverse torque	ft-lb	2,013
Hammer mechanism	type	Twin hammer
Sound level *	dB	105
Vibration **	m/s <sup>2</sup>	12.88
Minimum hose size	inch	3/4"
Air inlet	inch	1/2"
Air consumption at 100% int.	l/min	271
Air consumption at 100% int.	cfm	9.6
Air consumption at 15% int.	l/min	41
Air consumption at 15% int.	cfm	1.4
Length	mm	504.5
Weight	kg	8.1

\* A weighted sound pressure level at work station in accordance with EN ISO 15744

\*\* Vibration value according to EN ISO 28927-2

Item ID: **ARWM11S**



**AIR DRILL 10MM CHUCK**

- Air drill with 10mm chuck
- Pistol style for easier use
- Suitable for left or right handed use
- Simple to use thumb switch lever for switching between forward and reverse
- Quick chuck mechanism for fast and easy changing of drill bits
- Composite grip protects against cold air

SPECIFICATION:		
Chuck size	mm	10
Free speed	rpm	1,800
Minimum hose size	inch	3/8"
Air inlet	inch	1/4"
Sound level *	dB	88
Vibration **	m/s <sup>2</sup>	3
Air consumption at 100% int.	l/min	121
Air consumption at 100% int.	cfm	4
Air consumption at 15% int.	l/min	18
Air consumption at 15% int.	cfm	0.7
Length	mm	206.2
Weight	kg	1.2

\* A weighted sound pressure level at work station in accordance with EN ISO 15744

\*\* Vibration value according to EN ISO 28927-2

Item ID: **ARD10**





### AIR DRILL 13MM CHUCK

- Air drill with 10mm chuck
- Pistol style for easier use
- Suitable for left or right handed use
- Simple to use thumb switch lever for switching between forward and reverse
- Quick chuck mechanism for fast and easy changing of drill bits
- Composite grip protects against cold air

SPECIFICATION:		
Chuck size	mm	13
Free speed	rpm	450
Minimum hose size	inch	3/8"
Air inlet	inch	1/4"
Sound level *	dB	89
Vibration **	m/s <sup>2</sup>	2
Air consumption at 100% int.	l/min	140
Air consumption at 100% int.	cfm	5
Air consumption at 15% int.	l/min	21
Air consumption at 15% int.	cfm	0.8
Length	mm	249.5
Weight	kg	1.9

\* A weighted sound pressure level at work station in accordance with EN ISO 15744

\*\* Vibration value according to EN ISO 28927-2

Item ID: **ARD13**



### 245MM AIR SAW

- Air Saw with key hole saw function
- Small and easy to operate with low vibration and high cutting capacity
- Suitable for cutting steel plate, aluminium, copper, plastic, wood, etc.
- Compatible with standard saw blades
- Straight design with lever arm throttle for easier use
- Handle design insulates against cold air and vibration

SPECIFICATION:		
Stroke length	mm	10
Strokes per minute	bpm	9,000
Cutting capacity – steel	mm	3
Cutting capacity – aluminium	mm	3
Cutting capacity – wood	mm	4
Sound level *	dB	84
Vibration **	m/s <sup>2</sup>	<2.4
Minimum hose size	inch	3/8"
Air inlet	inch	1/4"
Air consumption at 100% int.	l/min	31
Air consumption at 100% int.	cfm	1.08
Air consumption at 15% int.	l/min	4.7
Air consumption at 15% int.	cfm	0.2
Length	mm	245.1
Weight	kg	0.7

\* A weighted sound pressure level at work station in accordance with EN ISO 15744

\*\* Vibration value according to EN ISO 28927-2

Item ID: **ARS01**







**170MM AIR SAW**

- Air Saw with key hole saw function
- Small and easy to operate with low vibration and high cutting capacity
- Suitable for cutting steel plate, aluminium, copper, plastic, wood, etc.
- Compatible with standard saw blades
- Straight design with lever arm throttle for easier use
- Handle design insulates against cold air and vibration

SPECIFICATION:		
Stroke length	mm	10
Strokes per minute	bpm	9,000
Cutting capacity – steel	mm	3
Cutting capacity – aluminium	mm	3.4
Cutting capacity – wood	mm	4
Sound level *	dB	84.4
Vibration **	m/s <sup>2</sup>	5.26
Minimum hose size	inch	3/8"
Air inlet	inch	1/4"
Air consumption at 100% int.	l/min	22.94
Air consumption at 100% int.	cfm	0.81
Air consumption at 40% int.	l/min	9.18
Air consumption at 40% int.	cfm	0.32
Length	mm	170
Weight	kg	0.45

\* A weighted sound pressure level at work station in accordance with EN ISO 15744

\*\* Vibration value according to EN ISO 28927-2

Item ID: **ARS02**



**AIR CUT OFF TOOL**

- For use with 3" / 76mm cut off discs
- Hole size is 3/8" / 10mm
- Reversible direction for better control of spark direction
- Suitable for left or right handed users
- Ergonomically designed trigger with safety throttle and speed control
- Handle design insulates against cold air and vibration
- Air exhaust in the handle to protect against cold air
- Safety guard above the cut off disc

SPECIFICATION:		
For cutting discs	mm	76x10mm, 3"x3/8"
Speed	rpm	18,000
Sound Level *	dB	98
Vibration **	m/s <sup>2</sup>	2.3
Minimum hose size	inch	3/8"
Connection thread	inch	1/4"
Air consumption at 100% int.	l/min	113
Air consumption at 100% int.	cfm	4
Air consumption at 40% int.	l/min	45
Air consumption at 40% int.	cfm	1.6
Weight	kg	0.9

\* A weighted sound pressure level at work station in accordance with EN ISO 15744

\*\* Vibration value according to EN ISO 28927-2

Item ID: **ARC80**





### STRAIGHT AIR DIE GRINDER

- Composite grip for added comfort
- Air exhaust in the handle to protect against cold air
- Silencer for noise reduction and quieter operation
- Safety throttle lever to avoid accidental operation

#### SPECIFICATION:

Angle		Straight
Collet	mm	6
Free speed	rpm	25,000
Sound level *	dB(A)	82
Vibration **	m/s <sup>2</sup>	5
Minimum hose size	inch	3/8
Air inlet	inch	1/4
Air consumption at 100% int.	l/min	113
Air consumption at 15% int.	l/min	17
Air consumption at 100% int.	cfm	4
Air consumption at 15% int.	cfm	0.6
Length	mm	161
Weight	g	400

\* A weighted sound pressure level at work station in accordance with EN ISO 15744

\*\* Vibration value according to EN ISO 28927-2

Item ID: **ARG01**



### AIR BELT SANDER

- For use with 6 and 10mm wide abrasive belts
- Fully adjustable grinding arm with 360° rotation
- Suitable for grinding metal, plastic or wood
- Ergonomically designed trigger with safety throttle and speed control
- Handle design insulates against cold air and vibration
- Supplied with grinding arms for 6mm and 10mm wide 330mm length belts
- 4 belts included

#### SPECIFICATION:

For sanding belt	mm	6 x 330, 10 x 330
Free speed	rpm	20,000
Sound pressure level *	dB	86
Sound power level	dB	97
Vibration **	m/s <sup>2</sup>	1
Measurement uncertainty (Standard)	m/s <sup>2</sup>	1
Min. hose size	inch	3/8"
Air inlet	inch	1/4"
Air consumption at 100% int.	l/min	119
Air consumption at 50% int.	l/min	59.5
Air consumption at 100% int.	cfm	4.2
Air consumption at 50% int.	cfm	2.1
Length	mm	331
Weight	kg	0.85

\* A weighted sound pressure level at work station in accordance with EN ISO 15744

\*\* Vibration value according to EN ISO 28927-2

Item ID: **ARBS10**





**AIR NEEDLE SCALER**

- For cleaning and descaling work
- Straight design with lever arm throttle
- Air exhaust in the handle to protect against cold air
- Supplied complete with needle equipment
- For use with 3mm diameter, 126mm length needles

SPECIFICATION:		
Stroke speed	bpm	4,000
No. of needles	pcs	12
Needle stroke	mm	24
Needle diameter x length (AXB)	mm	3 x 126
Sound pressure level *	dB	88.7
Vibration **	m/s <sup>2</sup>	3.8
Min. hose size	inch	3/8"
Air inlet	inch	1/4"
Air consumption at 100% int.	l/min	170
Air consumption at 20% int.	l/min	34
Air consumption at 100% int.	cfm	6
Air consumption at 20% int.	cfm	1.2
Total length	mm	310
Weight	kg	1.14

\* A weighted sound pressure level at work station in accordance with EN ISO 15744

\*\* Vibration value according to EN ISO 28927-2

Item ID: **ARN12**



**AIR RIVET GUN**

- For use with 2.4, 3.0, 3.2, 4.0, 4.8 or 5.0mm rivets
- For use with aluminium, copper, steel and stainless steel blind rivets
- Ergonomically designed to reduce fatigue from vibration
- Patented rivet size hole gauge to ensure the correct size rivet and nose piece are selected
- Spent mandrel container automatically collects spent mandrels
- Complete with hanging bracket for easier storage

SPECIFICATION:		
Traction force	N	9,000
Compressed air pressure stroke	mm	16
Sound pressure level *	dB	86
Sound power level	dB	97
Vibration **	m/s <sup>2</sup>	3
Air inlet	inch	1/4" PT-19
Min. hose size	inch	3/8"
Working Temperature	°C	0-40
Air consumption at 100% int.	l/rivet	2.1
Weight	g	1710

\* A weighted sound pressure level at work station in accordance with EN ISO 15744

\*\* Vibration value according to EN ISO 28927-2

Item ID: **ARRG80**

**SERVICE KITS FOR AIR RIVET GUN**

ITEM ID:	Description
ARRG80-1RK	Nosepieces (4 Pieces)
ARRG80-3RK	Jaw Case Assembly





### AIR ENGRAVING PEN

- With hardened metal stylus
- Suitable for use on plastic as well as metals including hardened steel
- Steel body with knurled grip and on/off control
- Supplied with 1.5 meter connection cable with 360° swivelling air inlet

SPECIFICATION:		
Working pressure	bar	6
Stroke speed	bpm	13,000
Sound Level *	dB	78
Sound power level	dB	90
Vibration **	m/s <sup>2</sup>	3
Air inlet	inch	1/4"
Air consumption at 100% int.	l/min	30
Air consumption at 50% int.	l/min	15
Air consumption at 100% int.	cfm	1.1
Air consumption at 50% int.	cfm	0.6
Weight	kg	0.22

\* A weighted sound pressure level at work station in accordance with EN ISO 15744

\*\* Vibration value according to EN ISO 28927-2

Item ID: **AREP25**



### AIR BLOW GUN

- Pistol grip with 1/4" air inlet
- Suitable for left or right handed use
- Low effort trigger mechanism for easier operation
- Metal thread insert for reliability
- Hole in the handle for use with fall protection wire

SPECIFICATION:		
Nozzle length	mm	100
Air inlet	inch	1/4"
Length	mm	212
Weight	g	106

Item ID: **ARB01**



### AIR BLOW GUN

- Pistol grip with 1/4" air inlet
- Suitable for left or right handed use
- Low effort trigger mechanism for easier operation
- Metal thread insert for reliability
- Hole in the handle for use with fall protection wire

SPECIFICATION:		
Nozzle length	mm	270
Air inlet	inch	1/4"
Length	mm	360
Weight	g	130

Item ID: **ARB02**



### AIR BLOW GUN

- Pistol grip with 1/4" air inlet
- Suitable for left or right handed use
- Low effort trigger mechanism for easier operation
- Metal thread insert for reliability
- Hole in the handle for use with fall protection wire

SPECIFICATION:		
Nozzle length	mm	100
Air inlet	inch	1/4"
Length	mm	212
Weight	g	160

Item ID: **ARB03**



# TENGTTOOLS COLLECTION

## Stand out from the crowd

Here you'll find an exciting range of high-quality products that represent the TengTools brand. We take pride in offering only the best quality products that are durable, reliable, and are sure to make a lasting impression.





### TENGTTOOLS TRAVEL BAG

- TengTools travel bag
- Handy travel bag with an adjustable shoulder strap and carrying handles
- Zip up pockets at each end for additional storage
- Internal base support to keep the shape of the bag
- Discreet TengTools logo
- Hardwearing and stylish
- 430 x 255 x 290mm

Item ID: **P-BM**



### TENGTTOOLS COMPUTER BAG

- TengTools computer bag
- Suitable for a tablet or compact lap top measuring up to 320 x 280mm
- Internal pockets give handy storage for cables, mobile phone, accessories, etc.
- Back pack style straps and a discreet TengTools eyes logo

Item ID: **P-CB**



### TENGTTOOLS BACK PACK

- TengTools back pack
- A versatile back pack with several compartments and pockets for storing things
- Fully adjustable padded back straps and a carrying handle
- Discreet TengTools logo and black trim for a stylish finish
- 310 x 120 x 470mm

Item ID: **P-BP2**



### TENGTTOOLS DRAWSTRING BAG

- TengTools bag
- A handy TengTools branded polyester bag
- Drawstrings double up as shoulder straps as well as closing the bag
- Ideal as a gym bag or as a light back pack
- 370 x 440mm

Item ID: **P-EZP**





### TENGTTOOLS LUGGAGE BELT

- A fully adjustable luggage strap for extra security on suitcases
- Suitcase not included

Item ID: **P-LB**

---



### TENGTTOOLS BASEBALL CAP BLACK

- TengTools baseball cap
- A stylish black baseball cap with an adjustable strap with a metal buckle
- Features the TengTools eyes logo embroidered on the front of the cap

Item ID: **P-CAP7**

---



### TENGTTOOLS BASEBALL CAP RED

- TengTools baseball cap
- A stylish red baseball cap with an adjustable strap with a metal buckle
- Features the TengTools eyes logo embroidered on the front of the cap

Item ID: **P-CAP8**

---



### TENGTTOOLS BANDANA / NECKER

- Can be worn as a snood-style scarf, a headband, a neck warmer or a bandana
- 100% polyester

Item ID: **P-HN11**

---



### TENGTTOOLS UMBRELLA

- A smart golf-style umbrella featuring the TengTools eyes logo

Item ID: **P-UMB16**

---





**TENGTTOOLS TENG TOOLS FLAG**

- A large (180x300cm) TengTools flag for use with 11 to 12-meter tent poles

Item ID: **P-TF01**



**TENGTTOOLS BAR STOOL**

- TengTools bar stool
- 755mm tall stylish bar stool
- Cushioned seat with 36cm diameter includes the TengTools eyes logo
- Distinctive, stylish and comfortable
- Ideal for use with the TengTools bar table (P-BT)

Item ID: **P-BCHR**



**TENGTTOOLS PALLET COVER**

- TengTools branded pallet cover
- size 120x80 cm and covers 4 pallets

Item ID: **PLAC**



**TENGTTOOLS BAR TABLE**

- TengTools bar table
- 600mm diameter bar table with TengTools branding
- Ideal for use with the TengTools bar stools (P-BCHR)

Item ID: **P-BT**







### TENGTTOOLS COASTER

- TengTools branded flexible coaster
- Durable material, ideal for hot and cold drinks
- 10cm diameter

Item ID: **P-COA10**



### TENGTTOOLS CORK SCREW

- TengTools cork screw
- Stainless steel cork screw with a fold up knife for use as a foil/plastic cutter
- Fold out lever for easy cork removal
- Supplied in handy storage wallet

Item ID: **P-CS**



### TENGTTOOLS BOTTLE OPENER

- TengTools bottle opener
- Ideal for opening bottles of beer, etc.
- Bi-material grip and hanging hole

Item ID: **P-COP02**



### TENGTTOOLS PLASTIC BEER GLASS

- Hard-wearing TengTools beer glass
- Ideal for outdoor use
- 500ml capacity

Item ID: **P-CUPBG**



### TENGTTOOLS WATER BOTTLE

- A 70cl water bottle with a sports-style drinking cap
- Distinctive TengTools branding

Item ID: **P-WSB14**



125° Hook Tool	425	Ball Point Tx Key Set	370	Combination Spanner Set	69
2 Arm Quick Action Universal Puller Set	438	Ball Point Tx Key Set	371	Combination Spanner Set	132
2 Arm Quick Action Universal Pullers	437	Ball Point Tx Keys	368	Combination Spanner Set	133
2 Arm Universal Puller Set	438	Ball Point Tx Keys	369	Combination Spanner Set	157,293
2 Arm Universal Pullers	437	Barn Style Tool Box	182	Combination Square	420
2 In 1 Magnetic Pick Up And Pen	451	Base Squares	420	Composite Air Impact Wrench	468
3 Arm Quick Action Universal Pullers	437	Bent Long Nose Pliers	381	Composite Air Impact Wrench	469
3 Arm Universal Pullers	437	Bicycle Tool Kit	373	Construction Impact Bit Set	348
3 In 1 Inspection Tool	451	Bi-Directional Torque Wrenches	280	Coupler Adaptors	236
35° Hook Tool	425	Bi-Directional Torque Wrenches	282	Crimping Plier And Wire Stripper	443
37" Roller Cabinet	177	Bi-Flex Wrench	311	Crimping Plier Set	93
37" Stack Tool Kit	17	Bit Adaptors For Sockets	345	Crimping Plier Set	93
37" Stack Tool Kit	101	Bit Holders	344	Crow Foot Wrench Set	213,252
37" Top Box	169	Bit Set	348	Crow Foot Wrenches	252
4 Piece Divider Set	184	Bit Set	350	Cutting Tool Set	87
4" Gear Puller	436	Bit Socket Set	58	Dead Blow Hammers	434
6mm/7mm Hose Clip Driver	425	Bits Driver	352	Deburring Tool	447
7" Gear Puller	436	Bits Driver	352	Deburring Tool	447
72 Teeth Ratchets	230	Bits Driver Extension	345	Deep 6 Point Impact Sockets	265
7mm Hose Clip Driver	425	Bits Driver Set	353	Deep 6 Point Impact Sockets	268
8mm Hose Clip Driver	425	Bits Set	348	Deep 6 Point Impact Sockets	269
9 Series - Tool Cabinet	176	Blank Key	190	Deep 6 Point Impact Sockets	272
9" Crimping Plier And Wire Stripper	442	Body Working Dollies	433	Deep 6 Point Impact Sockets	273
9" Crimping Plier And Wire Stripper	443	Body Working Hammer	434	Deep 6 Point Impact Sockets	268
90° Hook Tool	424	Bodywork Hammer Set	91,434	Deep 6 Point Impact Sockets	269
Adaptors	236	Bolt Cutter Replacement Jaws	378	Deep 6 Point Impact Sockets	272
Adjustable Tap Chuck	414	Bolt Cutters	378	Deep 6 Point Impact Sockets	273
Adjustable Wrench	316	Brackets For Middle Boxes	184	Deep 6 Point Impact Sockets	274
Adjustable Wrench	316	Brackets For Top Boxes	184	Deep Af Sockets	241
Adjustable Wrench Service Kit	316	Brake Cylinder Honing Tool	429	Deep Af Sockets	246
Adjustable Wrench Service Kit	317	Brake Pin Punch	429	Deep Af Sockets	247
Adjustable Wrench Service Kit	317	C Clamp Power Grip Pliers	391	Deep Impact Socket Set	227
Adjustable Wrench Set	73	C Clamp Power Grip Pliers	392	Deep Impact Socket Set	227
Adjustable Wrench Set	135	Cable Tie Gun	444	Deep Metric 12 Point Sockets	254
AF Combination Spanners	293	Cantilever Tool Box	182	Deep Metric 6 Point Sockets	254
AF Ratcheting Combination Spanners	302	Carpenters Pliers	379	Deep Metric Sockets	240
Air Belt Sander	473	Centre Punches	460	Deep Metric Sockets	245
Air Blow Gun	475	Chain Pipe Cutter	446	Deep Metric Sockets	246
Air Cut Off Tool	472	Chain Pipe Wrench	447	Deep Thinwall Metric Impact Sockets	275
Air Die Grinder Straight	473	Chrome Molybdenum Ball Point Hex Keys	360	Dial Indicator With Measuring Stand	419
Air Drill	470	Chrome Molybdenum Ball Point Hex Keys	360	Die Chuck	414
Air Drill	471	Circlip Plier Set	387	Die Handle	414
Air Engraving Pen	475	Circlip Plier Set	83	Digital Bi-Directional Torque Wrench	279
Air Impact Wrench	467	Circlip Plier Set	83	Digital Bi-Directional Torque Wrench	281
Air Impact Wrench	468	Circlip Plier Set	83	Digital Caliper	418
Air Impact Wrench Set	95	Circlip Plier Set	83	Digital Multimeter	444
Air Needle Scaler	474	Circlip Plier Set	84	Digital Torque Tester	288
Air Rivet Gun	474	Circlip Plier Set	84	Digital Torque Testers	288
Air Saw	471	Circlip Pliers	387	Disc Brake Pad Puller	429
Air Saw	472	Circlip Pliers	388	Double Ended Blades	328
Aluminium Pipe Reamers	447	Circlip Pliers	389	Double Ended Flat (Slotted) Bit	336
Aluminium Try Squares	420	Circuit Tester	444	Double Ended Mini Screwdriver Blades	321
Angled Ratcheting Bits Driver Set	354	Clamping Power Grip Pliers	393	Double Ended Ph Bits	336
Angled Ratcheting Bits Driver Set	79	Claw Hammer With Magnetic Nail Holder	459	Double Ended Pz Bits	338
Angular Gauge	286	Claw Hammers	459	Double Ended Tx Bits	339
Anti Slip Combination Spanner Set	299	Claw Pick Up Tool	450	Double Ended Wheel Nut Sockets	431
Anti Slip Combination Spanner Set	68	Clip Rail Set	52	Double Flex Wrench Set	72
Anti Slip Combination Spanner Set	132	Cold Chisels	460	Double Flex Wrench Set	135
Anti Slip Combination Spanner Set	157,299	Combination Pliers	380	Double Flex Wrench Set	158,311
Anti Slip Combination Spanners	298	Combination Spanner And File Set	134	Double Flex Wrenches	311
Assorted Key Set	372	Combination Spanner Set	133	Double Open Ended Spanner Set	310
Automatic Centre Punch	460	Combination Spanner Set	294	Double Open Ended Spanner Set	72
Automotive Socket Set	90	Combination Spanner Set	294	Double Open Ended Spanners	309
Awl	424	Combination Spanner Set	295	Double Ring Spanner Set	307
Ball Pein Hammers	458	Combination Spanner Set	297	Double Ring Spanner Set	308
Ball Point Hex Key Set	363	Combination Spanner Set	298	Double Ring Spanner Set	71
Ball Point Hex Key Set	365	Combination Spanner Set	298	Double Ring Spanner Set	135
Ball Point Hex Key Set	365	Combination Spanner Set	68	Double Ring Spanners	306
Ball Point Hex Keys	359	Combination Spanner Set	68	Drain Plug Keys	428
Ball Point Hex Keys	360	Combination Spanner Set	69	Drill Bit Set	413
				End Nippers	379

Engine Cylinder Honing Tool	429	Hacksaw & Knife Set	408	Hook On Tool Holder	195
Engineers Style Hammer	458	Hacksaw Blade Holder	407	Hook On Trays	195
Ev - Tool Cabinet	174	Hand File - Flat	416	Hook Wrenches	314
Eva Extra Wide Roller Cabinet Tool Kit	107	Hand File - Half Round	416	Hooks For Side Plates And Panels	187,195
Eva Portable Tool Kit	114	Hand File - Round	416	Hose Clamp Set	90
Eva Portable Tool Kit	114	Hand File - Square	416	Hose Clamps	426
Eva Roller Cabinet Tool Kit	108	Hand File - Triangular	416	Impact Accessories	263
Eva Roller Cabinet Tool Kit	110	Hand File Set	88	Impact Adaptor	344
Eva Roller Cabinet Tool Kit	111	Hand File Set	161	Impact Bit Set	348
Eva Stack System Tool Kit	103	Hand Rivet Gun	448	Impact Bit Set	349
Eva Stack System Tool Kit	104	Hand Rivet Gun With Swivel Head	449	Impact Bit Set	350
Extendable Ratchet	231	Handle For Interchangeable Blades	398	Impact Bit Set	351
Extendable Ratchet Set	62	Handle For Tool Cabinets	188	Impact Bit Set	354
Extension Bars	235	Handles For Top & Middle Boxes	188	Impact Bit Set	80
Extension Bars Set	61	Heavy Duty Cable Cutter	377	Impact Bit Set	140
Extension Bars Set	125	Heavy Duty Cable Cutters	377	Impact Driver Bits	355
Extra Long 6 Point Metric Impact Socket	273	Heavy Duty Cutters	378	Impact Driver Set	354
Extra Long 6 Point Metric Impact Socket	275	Heavy Duty Insulated Side Cutting Plier	400	Impact Driver Set	66
Extra Long Combination Spanner Set	301	Heavy Duty Oil Filter Removal Tool	428	Impact Driver Set	355
Extra Long Combination Spanners	300	Heavy Duty Ratchet	232	Impact Driver Set	66
Extra Long Double Ring Spanner Set	72	Heavy Duty Ratchet Head	232	Impact Magnetic Bits Holder	344
Extra Long Double Ring Spanner Set	135	Heavy Duty Ratchets	232	Impact Nut Setter Set	349
Extra Long Double Ring Spanners	307	Heavy Duty Tool Set	154	Impact Nut Setter Set	351
Extra Long Hex Key Set	363	Heavy Duty Utility Knife	411	Impact Nut Setters	344
Extra Long Hex Keys	359	Hex & Tx Bit Socket Set	61	Impact Screw Extractors	439
Extra Wide Roller Cabinet Tool Kit	33	Hex And Tx Wrench Set	81	Impact Socket Accessory Set	63
Extra Wide Roller Cabinet Tool Kit	35	Hex Bit Impact Sockets	265	Impact Socket Accessory Set	64
Extra Wide Stack System	166	Hex Bit Impact Sockets	269	Impact Socket Set	130
Extra Wide Tool Cabinet	178	Hex Bit Impact Sockets	270	Impact Socket Set	224
Extra Wide Tool Cabinet	179	Hex Bit Impact Sockets	273	Impact Socket Set	225
Extra Wide Top Box	170	Hex Bit Socket Set	211	Impact Socket Set	226
Extractor Set	92	Hex Bit Socket Set	212	Impact Socket Set	63
F Clamps	457	Hex Bit Socket Set	218	Impact Socket Set	64
F Clamps	457	Hex Bit Socket Set	219	Impact Socket Set	64
Fast Action Clamps	457	Hex Bit Socket Set	60	Impact Socket Set	65
Feeler Gauges	418	Hex Bit Socket Set	60	Impact Socket Set	66
Five Lock Set	190	Hex Bit Sockets	212	Impact Socket Set	129
Flare Nut Wrenches	312	Hex Bit Sockets	248	Impact Socket Set	129
Flaring Tool Set	91	Hex Bit Sockets	249	Impact Tx Bit Set	349
Flat (Slotted) Bits	336	Hex Bit Sockets	255	Individual Dies	414
Flat (Slotted) Blade Insulated Screw-drivers	396	Hex Bit Sockets	256	Individual Taps	413
Flat Bit Sockets	242	Hex Bit Sockets	260	Industrial Quality Workbenches	191
Flat Nose Pliers	381	Hex Bits	341	Insert Adaptor Set	236
Flat Screwdriver	324	Hex Bits	342	Insert Adaptors	236
Flat Screwdriver	324	Hex Bits	343	Insert Ratchet Adaptors	284
Flat Screwdriver	326	Hex Impact Bit Socket Set	65	Inspection Set	94
Flex Handle Service Kits	234	Hex Impact Screwdriver Bit	342	Inspection Set	95
Flex Handles	234	Hex Key Set	363	Insulated Combination Pliers	401
Flex Head Adaptor	235	Hex Key Set	365	Insulated Extension Bar	402
Flex Head Ratchets	231	Hex Key Set	367	Insulated Long Nose Pliers	401
Flexible Head Ratchet Spanner Set	70	Hex Key Set	367	Insulated Plier Set	86
Flexible Head Ratchet Spanners	305	Hex Keys	358	Insulated Plier Set	147
Flexible Led Light	453	Hex Keys	358	Insulated Plier Set	160,401
Flexible Light	453	Hex Screwdrivers	327	Insulated Ratchet	402
Flexible Spinner Handle	233	Hex, Tx And Screwdriver Key Set	142	Insulated Screwdriver And Plier Set	402
Flip Reverse Ratchets	231	High Leverage Left/Straight Cut Tin Snips	406	Insulated Screwdriver Set	399
Flush Cut Pliers	379	High Leverage Right/Straight Cut Tin Snips	406	Insulated Screwdriver Set	85
Foam Monster Tool Kit	99	High Leverage Straight Cut Tin Snips	406	Insulated Screwdriver Set	85
Folding Mini Utility Knife	411	Hinge Adjustment Wrench	457	Insulated Screwdriver Set	86
Folding Universal Utility Knife	411	Hinge Adjustment Wrenches	457	Insulated Screwdriver Set	147
Fully Ground Drill Bit	412	Hobby Knife Set	410	Insulated Screwdriver Set	160
Fully Ground Drill Bit Set	87	Hobby Knife With 18Mm Blade	410	Insulated Side Cutting Plier	400
Gasket Scraper	424	Hobby Knife With 9Mm Blade	409	Insulated Socket Set	86
General Tool Set	54	Hook & Pick Set	425	Insulated Socket Set	148
General Tool Set	120	Hook And Pick Set	89	Insulated Sockets	403
General Tool Set	121	Hook And Pin Wrench Set	73	Insulated Torque Screwdriver	278,400
General Tool Set	121	Hook On Bits Set	347	Insulated Torque Screwdriver Set	86
Grease Gun	436	Hook On Can Holder	195	Insulated Torque Screwdriver Set	147
Groove Joint Pliers	382	Hook On Impact Bits Set	347	Insulated Wire Stripping Pliers	401
				Interchangeable Blades	399
				Intricate Cutting Scissors	407

IPR - Tamper Proof Bit Set	346	Mini Screwdrivers - Hex Tip	320	Power Grip Plier Set	145
Kneeling Pad	454	Mini Screwdrivers - Ph Tip	320	Power Grip Plier Set	390
Large Capacity Sv Top Box	169	Mini Screwdrivers - Tx Tip	320	Power Grip Plier Set	84
Large Capacity Top Box	168	Mini Side Cutter	384	Power Grip Plier Set	84
Large Magnetic Bits Tray	455	Mini Starter Kit	156	Power Grip Pliers	389
Large Magnetic Bits Tray	455	Mini T-Handle Screwdrivers - Tx Tip	322	Power Grip Pliers	390
Lazy Tongue Rivet Gun	449	Mini Tool Box	181	Power Through Screwdriver	328
Led Head Lamp	452	Mini Tx Screwdriver Set	321	Power Through Screwdriver Set	75
Led Light Bar	195	Mini Tx T-Handle Screwdriver Set	322	Power Through Screwdriver Set	140
Led Torch	452	Mobile Trolleys	191	Power Through Screwdriver Set	159,329
Long Arm Flexible Ratchet	231	Monster Mega Master Tool Kit	15	Power Through Screwdrivers - Flat Tip	328
Long Arm Ratchet	231	Multi Drive Spanner Repair Kits	312	Power Through Screwdrivers - Ph Tip	328
Long Blade Straight Cut Tin Snips	406	Needle File	415	Professional Quality Hacksaw	407
Long Double Ring Spanner Set	158,307	Needle File Set	88	Professional Quality Hacksaw	407
Long Handled Nutsert Gun	450	Non Slip Mat	183	Professional Quality Hacksaw	407
Long Handled Rivet Gun	449	Nut And T Handle Driver Set	142	Protective Glasses	464
Long Hex Bit Sockets	256	Nut Driver Set	76	Protective Wing Cover	432
Long Nose Pliers	380	Nut Drivers	329	Pry Bar Set	92
Long Reach Combination Spanner Set	69	Nut Setters	343	Pry Bar Set	151
Long Reach Combination Spanner Set	157,301	Nut Splitter Set	440	Pry Bars	442
Long Reach Flexible Bits Driver	352	Nutsert Gun	449	P-Series Insert Torque Wrenches	284
Long Reach Pliers	382	Nutsert Gun Set	94	P-Series Torque Wrench Set	67
Long T-Bar Socket Set	91	Off Set Straight/Left Tin Snips	406	P-Series Torque Wrenches	279
Long Tx Bit Sockets	257	Off Set Straight/Right Tin Snips	405	P-Series Torque Wrenches	281
Lump Hammer	458	Oil Filter Removal Tool	427	P-Series Torque Wrenches	283
Machine Table Clamp Locking Pliers	393	Oil Filter Removal Tool	428	Punch And Chisel Set	461
Magnetic Aluminium Spirit Levels	422	Oil Filter Remover Plier	390	Punch And Chisel Set	95
Magnetic Angle Blocks	456	Oil Service Set	90	Punch And Chisel Set	151
Magnetic Bits Tray	455	Open Ended Insert Spanner	285	Punch And Chisel Set	161,461
Magnetic Bracelet	455	Open Ended Insert Spanner	286	PZ Bit Sockets	242
Magnetic Charger	329	Open Ended Slogging Wrenches	315	PZ Bits	338
Magnetic Plastic Bowl	455	Parallel Pin Punch Set	461	PZ Blade Insulated Screwdrivers	397
Magnetic Side Shelf	185	Parallel Pin Punches	460	PZ Impact Screwdriver Bit	339
Magnetic Side Shelf	185	PH Bit Sockets	242	PZ Screwdriver	325
Magnetic Tool Rail	187	PH Bits	337	PZ Screwdriver	325
Magnifying Glass	453	PH Blade Insulated Screwdrivers	397	Quick Chuck Bits Driver Set	141
Measuring Tapes	421	PH Impact Screwdriver Bit	337	Quick Clamps	456
Measuring Tool Set	89	PH Screwdriver	325	Quick Set Water Pump Pliers	382
Measuring Tool Set	150	PH Screwdriver	325	Quick Set Water Pump Pliers	383
Mechanics Creeper	454	PH Screwdriver	326	Quick Wrench Set	73
Mechanics Socket Set	216	PH2G Bits	337	Quick Wrenches	314
Mechanics Starter Kit	44	PH2G Impact Screwdriver Bit	338	Ratchet & Accessories Set	58
Mechanics Starter Kit	45	Pin Wrenches	314	Ratchet & Accessories Set	62
Mechanics Stool	454	Pipe Cutter	445	Ratchet & Accessories Set	125
Mega Bite Cable Cutters	377	Pipe Cutter	445	Ratchet Action Crimping Plier	442
Mega Bite Side Cutters	376	Pipe Cutter Set	93	Ratchet Combination Spanners	305
Mega Master Tool Kit	19	Pipe Reamer	447	Ratchet Head & Bits Holder	230
Mega Master Tool Kit	21	Pipe Wrenches	383	Ratchet Service Kits	232
Metric Combination Spanners	292	Piston Ring Compressor	428	Ratchet Spanner Set	303
Micrometer	418	Plier & Wrench Set	82	Ratchet Spanner Set	304
Middle Box	170	Plier And Hammer Set	119	Ratchet Spanner Set	69
Middle Box	171	Plier Set	143	Ratchet Spanner Set	70
Midget Combination Spanner Set	68	Plier Set	144	Ratchet Spanner Set	70
Mini Air Impact Wrench	466	Plier Set	383	Ratchet Spanner Set	71
Mini Bent Nose Plier	385	Plier Set	81	Ratchet Spanner Set	134
Mini Bits Ratchet	230	Plier Set	82	Ratchet Spanner Set	134
Mini End Cutter	384	Plier Set	82	Ratchet Spanner Set	157,304
Mini Flat Nose Plier	385	Plier Set	143	Ratcheting Bits Driver Set	353
Mini Hacksaw	408	Plier Set	160	Ratcheting Bits Driver Set	353
Mini Hacksaw	408	Plus/Minus Blade Insulated Screwdrivers	398	Ratcheting Combination Spanner	302
Mini Long Nose Plier	384	Pocket Sized Double Ring Spanner	307	Ratcheting Combination Spanners	303
Mini Needle Nose Plier	385	Portable Service Case	181	Ratcheting Multi Drive Ring Spanner Set	312
Mini Palm Ratchet	230	Portable Tool Kit	46	Ratcheting Multi Drive Ring Spanners	312
Mini Pliers & Screwdriver Set	76	Portable Tool Kit	47	Ratcheting Offset Ring Spanner Set	73
Mini Ratchet	230	Portable Tool Kit	48	Ratcheting Offset Ring Spanners	313
Mini Round Nose Plier	385	Portable Tool Kit	155	Ratcheting Offset Tx-E Wrench	313
Mini Screwdriver	320	Portable Tool Kit	156	Ratcheting Podger Wrenches	313
Mini Screwdriver	322	Portable Tool Panels	197	Regular 6 Point Impact Sockets	264
Mini Screwdriver Set	321	Portable Work Station With Tools	196	Regular 6 Point Impact Sockets	266
Mini Screwdriver Set	321	Power Bar	232	Regular 6 Point Impact Sockets	267
Mini Screwdrivers - Flat Tip	320				

Regular 6 Point Impact Sockets	271	Screwdriver Set	331	Socket Set	59
Regular 6 Point Impact Sockets	272	Screwdriver Set	332	Socket Set	60
Regular 6 Point Impact Sockets	274	Screwdriver Set	333	Socket Set	62
Regular 6 Point Metric Impact Sockets	275	Screwdriver Set	74	Socket Set	63
Regular AF Sockets	239	Screwdriver Set	74	Socket Set	122
Regular AF Sockets	244	Screwdriver Set	75	Socket Set	123
Regular AF Sockets	245	Screwdriver Set	75	Socket Set	124
Regular AF Sockets	253	Screwdriver Set	137	Socket Set	126
Regular AF Sockets	260	Screwdriver Set	137	Socket Set	201
Regular Impact Socket Set	226	Screwdriver Set With Pocket Clips	323	Socket Set	202
Regular Impact Socket Set	227	Screwdriver With Pocket Clip	322	Soft Face Hammer	458
Regular Metric 12 Point Sockets	253	Screwdriver With Pocket Clip	322	Spanner Ring	305
Regular Metric 6 Point Sockets	252	Screwdriver & Spanner Set	139	Spanner Set	134
Regular Metric Sockets	238	Scriber	450	Spare Blades	410
Regular Metric Sockets	243	Service Case	181	Spare Blades	411
Regular Metric Sockets	244	Service Case Tool Kit	48	Spare Blades	412
Regular Metric Sockets	253	Service Kits For Air Rivet Gun	474	Spare Heads For Cp52	442
Regular Metric Sockets	259	Service Kits For Nut Splitters	440	Spare Pipe Cutter Blades	445
Regular Metric Sockets	261	Service Kits For Stud Extractors	441	Spare Pipe Cutter Blades	445
Replacement Combination Locks	190	Service Tool Set	55	Spare Wheel Set	454
Replacement Key Locks	190	Sheet Metal Power Grip Pliers	393	Spark Plug Boot Plier	426
Replacement Pipe Cutter Chain	446	Shock Absorbing Claw Hammer	459	Spark Plug Socket Set	90
Replacemment Pins	314	Side Cabinet	180	Spark Plug Socket Set	150
Retaining Rings & Pins	263	Side Cabinet Transport Trolley	189	Spark Plug Sockets	426
RIBE & XZN Bit Socket Set	61	Side Cupboard	180	Specialist Automotive Sockets	430
RIBE Bit Sockets	213	Side Plate	186	Speed Braces	234
RIBE Bit Sockets	220	Side Table And Paper Roll Holder	186	Spinner Handle	233
RIBE Bit Sockets	251	Side Table For Mounting A Vice	186	Stack System	164
RIBE Bit Sockets	258	Sliding Bevel	420	Stack System	165
Ring Ended Insert Spanner	284	Sliding T-Bars	237	Stack System Cover	183
Ring Ended Insert Spanner	285	Socket & Bits Set	76	Stack System Tool Kit	23
Ring Type Slogging Wrenches	315	Socket & Bits Set	77	Stack System Tool Kit	25
Rivet Gun Set	94	Socket & Bits Set	78	Stack System Tool Kit	27
Rivet Gun Set	151	Socket & Bits Set	79	Stack System Tool Kit	29
ROB Bits	343	Socket & Tool Set	209	Stack System Tool Kit	31
ROB Blade Insulated Screwdriver	398	Socket & Tool Set	217	Steel Rules	419
ROB Impact Screwdriver Bit	343	Socket & Tool Set	222	Storage Tray	52
ROB Screwdriver	328	Socket Adaptor Set	63	Storage Tray	53
ROB Screwdriver	328	Socket And Spanner Set	133	Storage Tray	54
Roller Cabinet Cover	183	Socket Clip Rail Set	187	Storage Tray	118
Roller Cabinet Tool Kit	38	Socket Clip Rails	187	Straight Air Impact Wrench	470
Roller Cabinet Tool Kit	39	Socket Clips	187	Straight Cut Tin Snips	405
Roller Cabinet Tool Kit	37	Socket Set	125	Straight/Left Cut Tin Snips	405
Rotating Pipe Cutters	446	Socket Set	126	Straight/Right Cut Tin Snips	405
Rotating Spinner Handle	233	Socket Set	127	Stubby 6 Point Impact Socket	267
Round Nose Pliers	381	Socket Set	128	Stubby Combination Spanners	300
S Shaped Hook Tool	424	Socket Set	200	Stubby Impact Socket Set	227
Safety Glasses	462	Socket Set	201	Stud Extractor	441
Safety Glasses	463	Socket Set	202	Stud Extractor Set	92
Safety Glasses	464	Socket Set	203	Stud Extractors	441
Safety Hand Grip	460	Socket Set	204	Suction Lifter	433
Safety Utility Knife	411	Socket Set	205	Sv - Middle Box	171
Safety Wire	461	Socket Set	206	Sv - Top Box	168
Safety Wire	462	Socket Set	207	T Handle Bits Driver	352
Scissors	407	Socket Set	208	T Handle Hex Key Set	80
Scraper Set	89	Socket Set	210	T Handle Hex Key Set	80
Screw Clamps	456	Socket Set	214	T Handle Hex Key Set	81
Screw Extractor Set	440	Socket Set	215	T Handle Hex Key Set	141
Screw Extractor Set	414,439	Socket Set	217	T Handle Hex Keys	361
Screw Extractors	439	Socket Set	218	T Handle Hex Keys	362
Screwdriver & Hex Key Set	139	Socket Set	220	T Handle Nut Drivers	329
Screwdriver And Hex Key Set	140	Socket Set	221	T Handle Tx & Tpx Keys	369
Screwdriver Bit Set	78	Socket Set	222	T Handle Tx And Tpx Key Set	81
Screwdriver Bit Set	78	Socket Set	223	T Handle Tx Key Set	141
Screwdriver Blade	328	Socket Set	55	T Handle Tx/Tpx Key Set	159,371
Screwdriver Blade Set	75	Socket Set	56	Tap And Die Set	87
Screwdriver Blades	321	Socket Set	56	Tap And Die Set	88
Screwdriver Blades	328	Socket Set	57	Tap Chuck Service Kits	414
Screwdriver Rack	158	Socket Set	57	Tap Handle	413
Screwdriver Set	138	Socket Set	58	T-Bar Handle	237
Screwdriver Set	330	Socket Set	59	T-Bar Socket Set	248

T-Bar Sockets	247	TX Bit Socket Set	219
T-Bar Spark Plug Sockets	427	TX Bit Socket Set	60
T-Bar Spark Plug Sockets	247	TX Bit Socket Set	61
Telescopic Basin Tap Wrench	447	TX Bit Sockets	213
Telescopic Inspection Mirror	451	TX Bit Sockets	220
Telescopic Magnetic Pick Up Tool	451	TX Bit Sockets	243
Telescopic Magnifying Glass	451	TX Bit Sockets	250
Telescopic Wheel Wrenches	431	TX Bit Sockets	257
T-Handle Hex Key Set	159,362	TX Bits	339
Thread Cleaners	427	TX Bits	340
Thread Gauge	419	TX Bits	341
Three Lock Set	190	TX Impact Bit Socket Set	65
TJ Socket Set	200	TX Impact Screwdriver Bit	340
TJ Socket Set	201	TX Key Set	370
Tool Back Pack	182	TX Key Set	371
Tool Bag	183	TX Keys	368
Tool Box	182	TX Screwdriver	326
Tool Box Transport Trolley	189	TX Screwdriver	326
Tool Cabinet	172	TX-E Bit Socket Set	213
Tool Cabinet	173	TX-E Bit Socket Set	219
Tool Cabinet	174	TX-E Bit Sockets	242
Tool Cabinet	175	TX-E Bit Sockets	251
Tool Cabinet	176	TX-E Bit Sockets	255
Tool Cabinet Castor Wheels	188	Tyre Levers	432
Tool Cabinet Top Tray	184	Universal Joints	235
Tool Kit And Work Station	43	Universal Puller Set	91
Tool Panel Set For Tcw207N	196	Utility And Craft Knife Set	87
Top Box	167	Vernier Caliper	418
Top Box Cover	183	Voltage Tester	444
Torch	452	Wall Hanging Tool Cabinet	193
Torch	452	Wall Hanging Tool Cabinet	194
Torque Multiplier Service Kits	287	Water Pump Pliers	382
Torque Multiplier Set	67	Welding Plier Set	85
Torque Multiplier Set	132	Welding Power Grip Pliers	392
Torque Multiplier Support Legs	286	Welding Power Grip Pliers	393
Torque Multipliers	286	Wheel Nut Socket Set	431
Torque Multipliers	287	Wheel Nut Socket Set	432
Torque Screwdriver	278	Wheel Nut Sockets	431
Torque Screwdriver Set	66	Wheel Tool Set	150
Torque Screwdriver Set	131	Wide Jaw Adjustable Wrenches	317
Torque Screwdriver Set	131	Wide Tool Cabinet	177
Torque Spanner Set	287	Wire Cutters	379
Torque Spanners	287	Wire Stripping Plier	384
Torque Stick & Wheel Nut Socket Set	65	Wire Stripping Tool	443
Torque Sticks	271	Wire Stripping Tool	443
Torque Test Printer	289	Wire Twisting Plier	443
Torque Tester Stand	289	Wobble Extension Bars	234
Torque Tester With Stand & Printer	289	Wooktops For Tool Cabinets	187
Torque Wrench Service Kits	283	Work Bench Work Top	191
Torque Wrench Set	67	Work Station Add-On Panel Set	192
Torque Wrench Set	67	Work Station Left/Right Add-On Panel Set	193
Torque Wrench Set	132	Work Station Panel Set	192
Torque Wrenches	278	Workbench Panel Kit	191
Torque Wrenches	280	Workbench Vice	186
Torque Wrenches	282	Workstation Tool Kit	41
Tote Tray	184	XZN Bit Impact Sockets	271
Tower Pincer Pliers	379	XZN Bit Sockets	259
TPX Bit Socket Set	212	XZN Impact Bit Socket Set	224
TPX Bit Socket Set	219		
TPX Bit Sockets	251		
TPX Bit Sockets	258		
TPX Bits	341		
TPX Key	372		
TPX Key Set	372		
TPX Screwdriver	326		
TPX Screwdriver	326		
Tweezers	386		
Twin/Triple Leg Pullers	436		
TX Bit Impact Sockets	270		
TX Bit Set	346		
TX Bit Socket Set	212		

# Index Alphanumeric

1200-45E	231	1479MMR	363	3101035	358	320020	368
1200-72N	230	1479MMRL	363	310103BL	360	320020BL	368
1200-72NRK	232	1479TX	370	310104	358	320025	368
1200-72SN	231	1479TX1	370	3101045	358	320025BL	368
1200F	231	1486	346	310104BL	360	320027	368
1200FRK	232	1487	371	310105	358	320027BL	368
1200FRP	231	1488	346	310105BL	360	320030	368
1200FRPRK	232	1492AG-CT	278	310106	358	320030BL	368
1200L	231	1492AG-E	278	310106BL	360	320040	368
1201	234	1492AGERK	283	310107	358	320040BL	368
1201A	234	1492TSD	278	310107BL	360	320045	368
1201ARK	234	1492TVSD	278,400	310108	358	320045BL	368
1202	431	1498TPX	372	310108BL	360	320050	368
1202A	431	1499AF	365	310110	358	320050BL	368
120955-C	430	1499MM	364	310110BL	360	3205015	359
1292AG4-CT	280	1499MML	364	310112	358	320502	359
1292AG4R-CT	280	1499TX	370	310112BL	360	3205025	359
1292AG4RK	283	210705	342	310114	358	320503	359
1292AG4RRK	283	210706	342	310116	358	320504	359
1292AG-E4	280	210707	342	310120	358	320505	359
1292AG-E4R	280	210708	342	3105007	358	320506	359
1292AG-EP	280	210709	342	3105009	358	320508	359
1292AG-ER	280	210710	342	3105013	358	320510	359
1292AGERK	283	210712	342	3105015	358	3492AG1-CT	282
1292AGERRK	283	210714	342	3105015BL-C	359	3492AG2-CT	282
1292AGP-CT	280	210717	342	310502	358	3492AG-CT	282
1292AGR-CT	280	210719	342	3105025	358	3492AG-E	282
1292CQ200R	284	210805	343	3105025BL-C	359	3492AG-E1	282
1292D200	281	210806	343	310502BL-C	359	3492AG-E2	282
1292D200-CT	281	210807	343	310503	358	3492AG-ER	282
1292P100	281	210808	343	310503BL-C	359	3492AGERK	283
1292P100-CT	281	210809	343	310504	358	3492AGERRK	283
1292P100RK-1	283	210810	343	3105045	358	3492AGR-CT	282
1292P200	281	210812	343	310504BL-C	359	3492CQ500R	284
1292P200-CT	281	210814	343	310505	358	3492P500	283
1292P200RK-1	283	210817	343	3105055	358	3492P500-CT	283
1292P320	281	210819	343	310505BL-C	359	3492P500RK-1	283
1292P320-CT	281	220720	341	310506	358	3800-41E	231
1292P418	284	220725	341	310506BL-C	359	3800-41ERK	232
1292P912	284	220727	341	310507	358	3800-72N	230
1400-72MN	230	220730	341	310507BL-C	359	3800-72NRK	232
1400-72N	230	220740	341	310508	358	3800-72SN	231
1400-72NRK	232	220745	341	310508BL-C	359	3800FRP	231
1400-72SN	231	220750	341	310509	358	3800FRPRK	232
1400B	230	220755	341	310510	358	3892AG1-CT	278
1400B	346	220760	341	310510BL-C	359	3892AG1RK	283
1400FRP	231	220770	341	310511	358	3892AG3-CT	278
1400FRPRK	232	220820	341	310512	358	3892AG3RK	283
1400M	230	220825	341	310512BL-C	359	3892AG-E1	278
1424	367	220827	341	310514	358	3892AG-E3	278
1425	367	220830	341	310514BL-C	359	3892CQ100R	284
1471AF	367	220840	341	310516	358	3892D100	279
1471AFA	367	220845	341	310517	358	3892D100-CT	279
1471MM	366	220850	341	310517BL-C	359	3892P060	279
1471MMA	366	220855	341	310518	358	3892P060-CT	279
1473	373	220860	341	310519	358	3892P060RK-1	283
1473	432	220870	341	310519BL-C	359	3892P100	279
1474	365	2300	441	310522	358	3892P100-CT	279
1475	363	2912512	321	310527	358	3901025BL	360
1476NAF	366	2912513	321	310532	358	390103BL	360
1476NMM	365	2912514	321	310536	358	390104BL	360
1476NMM1	366	2912520	321	320008	368	390105BL	360
1476NTX	370	2912535	321	320008BL	368	390106BL	360
1476NTX1	371	2912537	321	320009	368	390107BL	360
1476NTX2	371	2912539	321	320009BL	368	390108BL	360
1477NX	372	310102	358	320010	368	390110BL	360
1479AF	365	3101025	358	320010BL	368	390112BL	360
1479MM	363	3101025BL	360	320015	368	3905015BL	360
1479MMA	364	310103	358	320015BL	368	3905025BL	360

390502BL	360	4008RK	316	510608	361	600134	293
390503BL	360	401-10	389	520009	369	600136	293
390504BL	360	401-10F	389	520010	369	600140	293
390505BL	360	401-12	389	520015	369	600142	293
390506BL	360	401-12F	389	520020	369	600144	293
390508BL	360	401-4	389	520025	369	600146	293
390510BL	360	401-5	389	520027	369	600148	293
3908015BL	359	401-7	389	520030	369	600152	293
3908020BL	359	402	390	520040	369	600156	293
3908025BL	359	404-4	390	520045	369	600160	293
390803BL	359	404-6	390	520050	369	6005055	292
390804BL	359	404-6S	390	520055	369	600506	292
390805BL	359	404-9	390	580	455	600507	292
390806BL	359	406	391	580A	455	600507RF	305
390808BL	359	406-6	391	580C	185	600508	292
390808TPX	372	406-6P	392	580CK	185	60050809RXRK	312
390809TPX	372	406-6S	391	580CM	185	60050811RX	312
390810BL	359	406-6SP	392	580CN	185	600508R	302
390810TPX	372	406P	392	580D	185	600508RF	305
390815TPX	372	406S	391	580J	185	600508RS	303
390820TPX	372	406SP	392	580K	185	600509	292
390825TPX	372	407	392	580M	185	600509R	302
390827TPX	372	407AS	393	580N	185	600509RF	305
390830TPX	372	408	393	580Q	455	600509RS	303
390840TPX	372	409	390	580R	455	600510	292
390908BL	369	409	427	580S	455	60051011RXRK	312
390909BL	369	409P	393	581N1	452	600510R	302
390910BL	369	409SP	393	581TMG	451	600510RF	305
390915BL	369	410P	393	581TMI	451	600510RS	303
390920BL	369	410SP	393	581TMP	451	600511	292
390925BL	369	418S	392	582MI	451	600511R	302
390927BL	369	418SP	392	582N1	452	600511RF	305
390930BL	369	445W	383	583M	455	600511RS	303
390940BL	369	480	387	583N1	452	600512	292
4001	316	490	405	585	452	60051213RXRK	312
4001RK	316	490W	406	585MP	451	60051215RX	312
4002	316	491	405	586	453	600512R	302
4002IQ	317	491W	406	586A	452	600512RF	305
40021QRK	317	492	405	586C	453	600512RS	303
4002RK	316	492W	406	587AA	453	600513	292
4002WT	317	493	405	587AE	453	600513R	302
4002WTRK	317	494	406	587AU	453	600513RF	305
4003	316	495	406	587H	453	600513RS	303
4003IQ	317	496	377	587J	195	600514	292
40031QRK	317	497	407	587M	453	60051415RXRK	312
4003J	316	498-7N	379	600	305	600514R	302
4003JRK	316	510103	362	600108	293	600514RF	305
4003RK	316	510104	362	600110	293	600514RS	303
4003WT	317	510105	362	600110R	302	600515	292
4003WTRK	317	510106	362	600112	293	600515R	302
4004	316	510107	362	600112R	302	600515RF	305
4004IQ	317	510108	362	600114	293	600515RS	303
40041QRK	317	510110	362	600114R	302	600516	292
4004RK	316	510502	361	600116	293	60051617RXRK	312
4004WT	317	5105025	361	600116R	302	60051619RX	312
4004WTRK	317	510503	361	600118	293	600516R	302
4005	316	510504	361	600118R	302	600516RF	305
4005IQ	317	510505	361	600120	293	600516RS	303
40051QRK	317	510506	361	600120R	302	600517	292
4005RK	316	510507	361	600122	293	600517R	302
4005WT	317	510508	361	600122R	302	600517RF	305
4005WTRK	317	510510	361	600124	293	600517RS	303
4006	316	510512	361	600124R	302	600518	292
4006IQ	317	5106025	361	600126	293	60051819RXRK	312
40061QRK	317	510603	361	600126R	302	600518R	302
4006RK	316	510604	361	600128	293	600518RF	305
4007	316	510605	361	600128R	302	600518RS	303
4007RK	316	510606	361	600130	293	600519	292
4008	316	510607	361	600132	293	600519R	302



600519RF	305	605911	300	6512MM1	295	690640	286
600519RS	303	605912	300	6512MMA	298	690641	286
600520	292	605913	300	6512N	293	690642	286
600520RS	303	605914	300	6512RSMM	304	690644	286
600521	292	605915	300	651415	311	690646	286
600521RS	303	605916	300	6515MM	295	690710	284
600522	292	605917	300	6515MMA	297	690711	284
600522R	302	605918	300	651617	311	690712	284
600522RS	303	605919	300	6517	294	690713	284
600523	292	6059LMP	301	6517MM	295	690714	284
600524	292	611214	311	651819	311	690715	284
600524R	302	611618	311	6521	294	690716	284
600524RS	303	612022	311	6526MM	296	690717	284
600525	292	620607	309	6607AF	310	690718	284
600526	292	6208	310	661416	312	690719	284
600527	292	620809	309	663032	309	690813	285
600527R	302	621011	309	663436	309	690814	285
600528	292	6211	310	663840	309	690815	285
600529	292	6211MM	310	664244	309	690816	285
600530	292	621213	309	664648	309	690817	285
600530R	302	621415	309	665052	309	690818	285
600532	292	621617	309	665456	309	690819	285
600532R	302	621819	309	6707AF	308	690821	285
600533	292	622022	309	673032	306	690822	285
600534	292	622123	309	673436	306	690824	285
600536	292	622427	309	673840	306	690826	285
600538	292	623032	309	674244	306	690827	285
600541	292	630607	306	674648	306	690829	285
600546	292	6308	307	675052	306	690830	285
600550	292	630809	306	675456	306	690832	285
600555	292	630810FL	307	680608	313	690834	285
600558	292	6308MM	308	680709	313	690836	285
600560	292	631011	306	680810E	313	690838	285
600565	292	6311	308	681013	313	690840	285
600570	292	631113FL	307	681112E	313	690841	285
6005M10	300	631213	306	681214	313	690842	285
6005M10RS	305	631214FL	307	681416E	313	690844	285
6005M11	300	631415	306	681719	313	690846	285
6005M11RS	305	631617	306	681820E	313	691406	311
6005M12	300	631618FL	307	682122	313	700-PRO5	408
6005M12RS	305	631719FL	307	682224E	313	701	407
6005M13	300	631819	306	690510	285	701N	407
6005M13RS	305	632022	306	690511	285	701N1	407
6005M14	300	632123	306	690512	285	702	407
6005M14RS	305	632224FL	307	690513	285	703A	408
6005M15	300	632427	306	690514	285	703A-10	408
6005M15RS	305	633032	306	690515	285	703A-24	408
6005M16	300	641011	312	690516	285	704	407
6005M16RS	305	641213	312	690517	285	705	408
6005M17	300	641314	312	690518	285	705-5	408
6005M17RS	305	641617	312	690519	285	705A	408
6005M18	300	641922	312	690613	286	705A-5	408
6005M18RS	305	6503RX	312	690614	286	710	411
6005M19	300	6507AF	297	690615	286	710-10	411
6005M19RS	305	6507JAF	297	690616	286	710-100	411
600813	314	6507JMM	296	690617	286	710-100H	412
600814	314	6507JMMA	298	690618	286	710-10H	412
600816	314	650809	311	690619	286	710A	409
600817	314	6508RMM	303	690621	286	710A-10	409
600819	314	6508RSMM	304	690622	286	710A-100	410
600822	314	6509AF	296	690624	286	710C	410
600824	314	651011	311	690626	286	710F	409
600827	314	651013	311	690627	286	710F-10	410
600830	314	6510A	297	690629	286	710F-100	410
600832	314	6510MM	294	690630	286	710G	410
601013	307	6510RMM	303	690632	286	710H	409
605908	300	6512	294	690634	286	710N	411
605909	300	651213	311	690636	286	710S	410
605910	300	6512MM	295	690638	286	710U-10	411

711	411	910546	274	920114	267	920529N	266
712	411	910550	274	920116	267	920530N	266
800608	298	910555	274	920118	267	920532N	266
800609	298	910560	274	920120	267	920610AN	268
800610	298	910565	274	920122	267	920610N	268
800611	298	910570	274	920124	267	920611AN	268
800612	298	910575	274	920126	267	920611N	268
800613	298	910580	274	920128	267	920612AN	268
800614	298	910585	274	920130	267	920612N	268
800615	298	910590	274	920132	267	920613AN	268
800616	298	910595	274	920134	267	920613N	268
800617	298	910624	275	920136	267	920614AN	268
800618	298	910627	275	920140	267	920614N	268
800619	298	910627R	274	920212	269	920615AN	268
8512A	299	910628	275	920214	269	920615N	268
8512MM	299	910630	275	920216	269	920616AN	268
902024	315	910630R	274	920218	269	920616N	268
902027	315	910632	275	920220	269	920617AN	268
902030	315	910632R	274	920222	269	920617N	268
902032	315	910633	275	920224	269	920618AN	268
902036	315	910633R	274	920226	269	920618N	268
902038	315	910636	275	920228	269	920619AN	268
902041	315	910732	275	920230	269	920619N	268
902046	315	9110	428	920232	269	920620N	268
902050	315	9110RK-1	428	920234	269	920621AN	268
902055	315	9120	428	920236	269	920621N	268
902060	315	912041	275	920240	269	920622AN	268
902065	315	912046	275	920242	269	920622N	268
902070	315	912050	275	920242	430	920623N	268
902075	315	912055	275	920248	269	920624AN	268
902080	315	912060	275	920248	430	920624N	268
902085	315	912065	275	9203N	432	920624N	430
902090	315	912070	275	9203N1	431	920627N	268
902095	315	912075	275	920508N	266	920627N	430
902100	315	912080	275	920510AN	266	920628N	268
903024	315	912085	275	920510N	266	920628N	430
903027	315	912090	275	920511AN	266	920629N	268
903030	315	912095	275	920511N	266	920629N	430
903032	315	9120HD	428	920512AN	266	920630N	268
903036	315	9120RK-1	428	920512N	266	920630N	430
903038	315	9121	227	920513AN	266	920632N	268
903041	315	912100	275	920513N	266	920632N	430
903046	315	912105	275	920514AN	266	920635N	268
903050	315	912110	275	920514N	266	920635N	430
903055	315	912115	275	920515AN	266	920636N	268
903060	315	912120	275	920515N	266	920636N	430
903065	315	912125	275	920516AN	266	920710-C	267
903070	315	912130	275	920516N	266	920712-C	267
903075	315	9123	427	920517AN	266	920713-C	267
903080	315	9123RK	427	920517N	431	920714-C	267
903085	315	9124	447	920517N1	266	920715-C	267
903090	315	9126	227	920518AN	266	920716-C	267
903095	315	920001	355	920518N	266	920717-C	267
903100	315	920002	355	920519AN	266	920718-C	267
910086	263	920003	355	920519N	431	920719-C	267
910504	355	920020AN	263	920519N1	266	920721-C	267
910505	355	920020N	263	920520N	266	920722-C	267
910506	355	920021AN	263	920521AN	266	920724-C	267
910508	355	920021N	263	920521N	431	9207512	227
910510	355	920023AN	263	920521N1	266	921210TX-C	270
910524	274	920023N	263	920522AN	266	921215TX-C	270
910527	274	920030AN	263	920522N	266	921220TX-C	270
910530	274	920030N	263	920523N	266	921225TX-C	270
910532	274	920036AN	263	920524AN	266	921227TX-C	270
910533	274	920036N	263	920524N	266	921230TX-C	270
910534	274	920037AN	263	920525N	266	921240TX-C	270
910536	274	920037N	263	920526N	266	921245TX-C	270
910538	274	920060-C	263	920527N	266	921250TX-C	270
910541	274	920112	267	920528N	266	921255TX-C	270

921260TX-C	270	940166	272	970040	355	ARRM38	466
921270TX-C	270	940168	272	970045	355	ARS01	471
921505-C	269	940170	272	970050	355	ARS02	472
921506-C	269	940172	272	970055	355	ARWC12	469
921508-C	269	940174	272	980020-C	263	ARWC34	469
921510-C	269	940176	272	980035-C	263	ARWC38	468
921512-C	269	940224	273	980036A-C	263	ARWM11S	470
921514-C	269	940226	273	980036-C	263	ARWM12	467
921517-C	269	940228	273	980060-C	263	ARWM12M	466
921519-C	269	940230	273	980086	263	ARWM34	468
921606	270	940232	273	980508-C	264	ARWM38	467
921608	270	940234	273	980510-C	264	AT020	428
921610	270	940236	273	980511-C	264	AT040	429
921612	270	940238	273	980512-C	264	AT040-SM	429
921614	270	940240	273	980513-C	264	AT080	426
921616	270	940242	273	980514-C	264	AT085	426
921618	270	940244	273	980515-C	264	AT090	426
921620	270	940246	273	980516-C	264	AT096	382
921622	270	940248	273	980517-C	264	AT097	382
921624	270	940250	273	980519-C	264	AT135	450
921814	271	940252	273	980608-C	265	AT135M	450
921816	271	940254	273	980610-C	265	AT170	429
921817	271	940256	273	980611-C	265	AT180	429
921818	271	940258	273	980612-C	265	AT180-S	429
923090	271	940258	430	980613-C	265	AT191	429
923110	271	940260	273	980614-C	265	AT192	429
923120	271	940519-C	271	980616-C	265	AT194	429
923140	271	940521-C	271	980617-C	265	AT20512	432
923814	271	940522-C	271	980619-C	265	AT20516	432
923816	271	940523-C	271	981504-C	265	AT20520	432
923817	271	940524-C	271	981505-C	265	AT20524	432
923818	271	940527-C	271	981506-C	265	AT330	429
9291719	431	940528-C	271	981507-C	265	AT350	430
9292122	431	940530-C	271	981508-C	265	AT355	430
930001	355	940532-C	271	981510-C	265	AT360	430
930002	355	940533-C	271	981512-C	265	AT365	430
930003	355	940534-C	271	9850	444	AT370	430
930004	355	940536-C	271	AB200	420	AT375	430
9381	226	940538-C	271	ABS-TOP	184	AT380	430
9386	227	940540-C	271	ACC300CBH01	345	AT415	433
940006	355	940541-C	271	ACC35CBH01	344	AT420	433
940008	355	940546-C	271	ACC50CBH01	344	AT500	436
940010	355	940550-C	271	ACC50MBH01	344	AT605	443
940012	355	940619-C	272	ACC70MBH01	344	BC408	378
940022-C	263	940621-C	272	ACCSDA1412	345	BC408T	378
940030-C	263	940622-C	272	ACCSDA1414	345	BC414	378
940037-C	263	940623-C	272	ACCSDA1438	345	BC414J	378
940085-C	263	940624-C	272	ACD01	287	BC418	378
940122	272	940627-C	272	ALU1000-1	187	BC418J	378
940124	272	940630-C	272	ALU1000-4	187	BC424	378
940126	272	940632-C	272	ALU12	187	BC424J	378
940128	272	940633-C	272	ALU14	187	BC430	378
940130	272	940634-C	272	ALU34	187	BC430J	378
940132	272	940636-C	272	ALU38	187	BC436	378
940134	272	940638-C	272	ALU430	187	BC436J	378
940136	272	940641-C	272	ALU450	187	BDIS-TYR	430
940138	272	940641-C	430	ARB01	475	BWT406	447
940140	272	940646-C	272	ARB02	475	CALD150	418
940142	272	940650-C	272	ARB03	475	CALV150	418
940144	272	940732-C	273	ARBS10	473	CC150F	460
940146	272	941519-C	273	ARC80	472	CC200F	460
940148	272	941522-C	273	ARD10	470	CC240F	460
940150	272	941524-C	273	ARD13	471	CC250F	460
940152	272	960506-C	264	AREP25	475	CMD12	456
940154	272	960507-C	264	ARG01	473	CMD16	456
940156	272	960508-C	264	ARN12	474	CMD20	456
940160	272	960510-C	264	ARRG80	474	CMD25	456
940162	272	960513-C	264	ARRG80-1RK	474	CMD30	456
940164	272	970030	355	ARRG80-3RK	474	CMD30A	456

CMD40	456	DBX120	412	HEX5000603	342	HRLR01RK-3	449
CMD40A	456	DBX125	412	HEX5000803	342	HRLT01	449
CMD50	456	DBX130	412	HEX8900401	342	HRLT01RK	449
CMDB80	456	DETO1	447	HEXP3000301	342	IBA14	344
CMF16	457	DETO1RK	447	HEXP3000305	342	ID506	354
CMF16T	457	DETO2	447	HEXP3000401	342	ID506BIT	354
CMF20	457	DGMM	419	HEXP3000405	342	ID515	355
CMF20T	457	DHW1300	457	HEXP3000501	342	ID515BIT	354
CMF25	457	DHW1417	457	HEXP3000505	342	IDSE7	355
CMF25T	457	DHW1922	457	HEXP3000601	342	KP01	454
CMF30	457	DIE-HNDL	414	HEXP3000605	342	KP02	454
CMF30T	457	DIS-SP05	438	HEXP5000301	342	KP03	454
CMF35	457	DIS-SP05Q	438	HEXP5000401	342	M1100	232
CMF35T	457	DM550	444	HEXP5000501	342	M110010	232
CMFQ20	457	DP0810	428	HEXP5000601	342	M110020	232
CMFQ25	457	DP0812	428	HMBH01	434	M110030	236
CMFQ30	457	DPI012	428	HMBH02	434	M110040	235
CMFQ40	457	DPT112	428	HMBH03	434	M110050	235
CMQ150	456	DP1314	428	HMBPI2	458	M110070	234
CMQ300	456	DP1716	428	HMBPI6	458	M110070RK	234
CMQ450	456	DTQ100RK	283	HMBP24	458	M1100-72	232
CMQ600	456	DTQ200RK	283	HMBP32	458	M1100-72RK	232
CMQL150	456	FC01	432	HMCH08A	459	M1100RK	232
CMQL300	456	FG13100	418	HMCH13A	459	M110536	261
CMQL450	456	FG20100	418	HMCH16A	459	M110541	261
CP04	460	FG20200	418	HMCH16M	459	M110546	261
CP04RK1	442	FL2506A03	336	HMCH20A	459	M110550	261
CP04RK2	442	FL2506B03	336	HMCHM16	459	M110555	261
CP04RK3	442	FL2508A03	336	HMDH35	434	M110558	261
CP05	460	FL2508B03	336	HMDH45	434	M110560	261
CP08	460	FL2510A03	336	HMDH55	434	M110565	261
CP50	442	FL2512A03	336	HMDH65	434	M110570	261
CP51	443	FL2516A03	336	HMEG300	458	M110575	261
CP52	442	FL5006A03	336	HMEG500	458	M110580	261
CP53	443	FL5008A03	336	HMEG800	458	M1115MM	221
CP55	443	FL5008B03	336	HMS1250	458	M120010-C	234
CP58	442	FL5010A03	336	HMSF	458	M120010RK	234
CP60	443	FL5012A03	336	HMSFRK	458	M120011-C	234
CTC01	444	FL7006A02	336	HN02	449	M120020-C	235
DB028	413	FL7008A02	336	HN02RK	449	M120020W-C	234
DB034	413	FL7008B02	336	HP101	314	M120021-C	235
DBT35	447	FL7010A02	336	HP102	314	M120021W-C	234
DBT41	447	FL8905A01	336	HP103	314	M120022-C	235
DBT54	447	FL8908A01	336	HP2014	314	M120022W-C	234
DBX010	412	FLFT10	416	HP2014-P	314	M120023-C	235
DBX015	412	FLHF10	416	HP2015	314	M120024-C	235
DBX020	412	FLHR10	416	HP2015-P	314	M120030-C	235
DBX025	412	FLRD10	416	HP2025	314	M120036-C	236
DBX030	412	FLSQ10	416	HP2026	314	M120037-C	236
DBX033	412	FLTR10	416	HP2026-P	314	M120037M	236
DBX035	412	FTF32406005	336	HP2036	314	M120040-C	426
DBX040	412	FTF4055	328	HP2036-P	314	M120042-C	426
DBX042	412	GR25002010	337	HP2038	314	M120046-C	426
DBX045	412	GR25002100	337	HP2038-P	314	M120050-C	237
DBX050	412	GRP3000201	338	HR01	448	M120060-C	236
DBX055	412	GRP3000205	338	HR01RK	448	M120060-C	345
DBX060	412	GRP5000201	338	HR12	448	M120061-C	236
DBX065	412	HBH0303	328	HR12RK	448	M120061-C	345
DBX068	412	HBH0404	328	HR12RK	449	M120062-C	236
DBX070	412	HBH0505	328	HR14	448	M120062-C	345
DBX075	412	HBH0606	328	HR14RK	448	M120063-C	236
DBX080	412	HEX2500203	341	HR30R	448	M120063-C	345
DBX085	412	HEX2500303	341	HR30RRK-1	448	M120080-C	235
DBX090	412	HEX2500403	341	HR30RRK-2	448	M120112-C	253
DBX095	412	HEX2500503	341	HR360R	449	M120114-C	253
DBX100	412	HEX2500603	341	HRLN65N	450	M120116-C	253
DBX105	412	HEX2500803	341	HRLN65NRK-1	450	M120118-C	253
DBX110	412	HEX5000403	342	HRLR01	449	M120119-C	253
DBX115	412	HEX5000503	342	HRLR01RK-2	449	M120120-C	253

M120122-C	253	M120615-C	254	M121509-C	255	M14010612-C	239
M120124-C	253	M1206166-C	254	M121510-C	255	M140106-C	239
M120125-C	253	M120616-C	254	M121512-C	255	M14010712-C	239
M120126-C	253	M1206176-C	254	M121514-C	255	M140107-C	239
M120128-C	253	M120617-C	254	M121515-C	255	M14010812-C	239
M120130-C	253	M1206186-C	254	M121516-C	255	M140108-C	239
M120132-C	253	M120618-C	254	M121517-C	255	M14010912-C	239
M120134-C	253	M1206196-C	254	M121518-C	255	M140109-C	239
M120136-C	253	M120619-C	254	M121519-C	255	M14011012-C	239
M120138-C	253	M120620-C	254	M1215AF	218	M140110-C	239
M120140-C	253	M120621-C	254	M1215MM	217	M14011112-C	239
M1205086-C	252	M120622-C	254	M122220T-C	257	M140111-C	239
M120508-C	253	M1206246-C	254	M122225T-C	257	M14011212-C	239
M120509-C	253	M120624-C	254	M122227T-C	257	M140112-C	239
M1205106-C	252	M120627-C	254	M122230T-C	257	M14011412-C	239
M120510-C	253	M120630-C	254	M122240T-C	257	M140114-C	239
M1205116-C	252	M120632-C	254	M122245T-C	257	M14011612-C	239
M120511-C	253	M120636-C	254	M122250T-C	257	M140116-C	239
M1205126-C	252	M1207	217	M122255T-C	257	M14020612-C	241
M120512-C	253	M120710-C	255	M122260T-C	257	M140206-C	241
M1205136-C	252	M120711-C	255	M122270T-C	257	M14020712-C	241
M120513-C	253	M120712-C	255	M122505-C	256	M140207-C	241
M1205146-C	252	M120714-C	255	M122506A-C	256	M14020812-C	241
M120514-C	253	M120716-C	255	M122506-C	256	M140208-C	241
M1205156-C	252	M120718-C	255	M122507-C	256	M14020912-C	241
M120515-C	253	M120720-C	255	M122508A-C	256	M140209-C	241
M1205166-C	252	M120722-C	255	M122508-C	256	M14021012-C	241
M120516-C	253	M120724-C	255	M122510-C	256	M140210-C	241
M1205176-C	252	M1208-6	218	M122510L-C	256	M14021112-C	241
M120517-C	253	M1209	220	M122512-C	256	M140211-C	241
M1205186-C	252	M1209AF	218	M122514-C	256	M14021212-C	241
M120518-C	253	M1209TX	220	M122517-C	256	M140212-C	241
M1205196-C	252	M1210	219	M122704-C	258	M14021412-C	241
M120519-C	253	M1211	219	M122705-C	258	M140214-C	241
M1205206-C	252	M121106-C	256	M122706-C	258	M14021612-C	241
M120520-C	253	M121107-C	256	M122708-C	258	M140216-C	241
M1205216-C	252	M121108-C	256	M122709-C	258	M14050412-C	238
M120521-C	253	M121109-C	256	M122710-C	258	M1405045-C	238
M1205226-C	252	M121110-C	256	M122711-C	258	M140504-C	238
M120522-C	253	M121112-C	256	M122712-C	258	M14050512-C	238
M1205236-C	252	M121116-C	256	M122713-C	258	M140505512-C	238
M120523-C	253	M121118-C	256	M122805-C	259	M1405055-C	238
M1205246-C	252	M121120-C	256	M122806-C	259	M140505-C	238
M120524-C	253	M1212	218	M122808-C	259	M14050612-C	238
M1205256-C	252	M121220-C	258	M122809-C	259	M140506-C	238
M120525-C	253	M121220T-C	257	M122810-C	259	M14050712-C	238
M1205266-C	252	M121225-C	258	M122812-C	259	M140507-C	238
M120526-C	253	M121225T-C	257	M122814-C	259	M14050812-C	238
M1205276-C	252	M121227-C	258	M122816-C	259	M140508-C	238
M120527-C	253	M121227T-C	257	M140015-C	233	M14050912-C	238
M1205286-C	252	M121230-C	258	M140020-C	235	M140509-C	238
M120528-C	253	M121230T-C	257	M140021-C	235	M14051012-C	238
M1205296-C	252	M121240-C	258	M140022-C	235	M140510-C	238
M120529-C	253	M121240T-C	257	M140023-C	235	M14051112-C	238
M1205306-C	252	M121245-C	258	M140024-C	235	M140511-C	238
M120530-C	253	M121245T-C	257	M140030-C	235	M14051212-C	238
M1205326-C	252	M121250-C	258	M140036-C	236	M140512-C	238
M120532-C	253	M121250T-C	257	M140036M	236	M14051312-C	238
M1205336-C	252	M121255-C	258	M140037	236	M140513-C	238
M1205346-C	252	M121255T-C	257	M140038-C	235	M140604-C	240
M120534-C	253	M121260-C	258	M140039	236	M1406055-C	240
M120610-C	254	M121260T-C	257	M140050-C	237	M140605-C	240
M120611-C	254	M1212N1	214	M140060-C	236	M14060612-C	240
M120612-C	254	M1213TPX	219	M140060-C	345	M140606-C	240
M1206136-C	254	M1213TX	219	M140070	414	M14060712-C	240
M120613-C	254	M121505-C	255	M140071	414	M140607-C	240
M1206146-C	254	M121506-C	255	M140071RK	414	M14060812-C	240
M120614-C	254	M121507-C	255	M140072	414	M140608-C	240
M1206156-C	254	M121508-C	255	M140072RK	414	M14060912-C	240

M140609-C	240	M340158-C	260	M380214-C	246	M38062012-C	246
M14061012-C	240	M340160-C	260	M38021612-C	247	M380620-C	245
M140610-C	240	M340164-C	260	M380216-C	246	M38062112-C	246
M14061112-C	240	M3405196-C	259	M38021812-C	247	M380621-C	245
M140611-C	240	M3405216-C	259	M380218-C	246	M38062212-C	246
M14061212-C	240	M3405226-C	259	M38022012-C	247	M380622-C	245
M140612-C	240	M3405246-C	259	M380220-C	246	M3807	210
M14061312-C	240	M3405266-C	259	M38022212-C	247	M380710-C	251
M140613-C	240	M3405276-C	259	M380222-C	246	M380712-C	251
M1407	205	M3405306-C	259	M38022412-C	247	M380714-C	251
M140704-C	242	M3405326-C	259	M380224-C	246	M380716-C	251
M140705-C	242	M3405336-C	259	M380226-C	246	M380718-C	251
M140706-C	242	M3405346-C	259	M380228-C	246	M3808MM	213,252
M140707-C	242	M3405366-C	259	M380507-C	243	M3809	212
M140708-C	242	M3405386-C	259	M38050812-C	244	M3809TX	213
M1408TX	205	M3405416-C	259	M380508-C	243	M3811	212
M1410T5	346	M3405466-C	259	M38050912-C	244	M381103-C	249
M1412	205	M3405506-C	259	M380509-C	243	M381104-C	249
M141210T-C	243	M341514-C	260	M38051012-C	244	M381105-C	249
M141215T-C	243	M341517-C	260	M380510-C	243	M381106-C	249
M141220T-C	243	M341519-C	260	M38051112-C	244	M381107-C	249
M141225T-C	243	M341522-C	260	M380511-C	243	M381108-C	249
M141227T-C	243	M380010A-C	234	M38051212-C	244	M381110-C	249
M141230T-C	243	M380011-C	234	M380512-C	243	M381112-C	249
M141240T-C	243	M380015-C	233	M38051312-C	244	M3812	211
M141300-C	242	M380020-C	235	M380513-C	243	M381210-C	251
M141301-C	242	M380020W-C	234	M38051412-C	244	M381210T-C	250
M141302-C	242	M380021-C	235	M380514-C	243	M381215-C	251
M141303-C	242	M380021W-C	234	M38051512-C	244	M381215T-C	250
M1413N1	200	M380022-C	235	M380515-C	243	M381220-C	251
M141404-C	242	M380022W-C	234	M38051612-C	244	M381220T-C	250
M1414055-C	242	M380023-C	235	M380516-C	243	M381225-C	251
M141407-C	242	M380024-C	235	M38051712-C	244	M381225T-C	250
M141601-C	242	M380030-C	235	M380517-C	243	M381227-C	251
M141602-C	242	M380035-C	236	M38051812-C	244	M381227T-C	250
M141603-C	242	M380036-C	236	M380518-C	243	M381230-C	251
M340020-C	235	M380036M	236	M38051912-C	244	M381230T-C	250
M3400205-C	235	M380037	236	M380519-C	243	M381240-C	251
M340021-C	235	M380039-C	426	M380520-C	243	M381240T-C	250
M3400215-C	235	M380040-C	426	M380521-C	243	M381245-C	251
M340022-C	235	M380041-C	426	M38052212-C	244	M381245T-C	250
M3400225-C	235	M380042-C	426	M380522-C	243	M381250-C	251
M340030-C	235	M380046-C	426	M3806	213	M381250T-C	250
M340050-C	237	M380047-C	426	M38060712-C	246	M3812N1	206
M3400505-C	237	M380050-C	237	M380607-C	245	M3813TPX	212
M340070-C	234	M380060-C	236	M38060812-C	246	M3813TX	212
M340070RK	234	M380060-C	345	M380608-C	245	M3814	213
M3400705-C	234	M380061-C	236	M38060912-C	246	M381503-C	248
M3400705RK	234	M380061-C	345	M380609-C	245	M381504-C	248
M3400-72	232	M380110-C	244	M38061012-C	246	M3815055-C	248
M340072E	231	M38011212-C	245	M380610-C	245	M381505-C	248
M3400-72RK	232	M380112-C	244	M38061112-C	246	M381506-C	248
M340085-C	236	M38011412-C	245	M380611-C	245	M381507-C	248
M340085M	236	M380114-C	244	M38061212-C	246	M381508-C	248
M340086-C	236	M38011612-C	245	M380612-C	245	M381510-C	248
M340124-C	260	M380116-C	244	M38061312-C	246	M381512-C	248
M340128-C	260	M38011812-C	245	M380613-C	245	M3816	210
M340130-C	260	M380118-C	244	M38061412-C	246	M382210T-C	250
M340132-C	260	M38012012-C	245	M380614-C	245	M382215T-C	250
M340134-C	260	M380120-C	244	M38061512-C	246	M382220T-C	250
M340136-C	260	M38012212-C	245	M380615-C	245	M382225T-C	250
M340138-C	260	M380122-C	244	M38061612-C	246	M382227T-C	250
M340140-C	260	M38012412-C	245	M380616-C	245	M382230T-C	250
M340142-C	260	M380124-C	244	M38061712-C	246	M382240T-C	250
M340144-C	260	M380126-C	244	M380617-C	245	M382245T-C	250
M340146-C	260	M380128-C	244	M38061812-C	246	M382250T-C	250
M340148-C	260	M38021212-C	247	M380618-C	245	M382503-C	249
M340152-C	260	M380212-C	246	M38061912-C	246	M382504-C	249
M340156-C	260	M38021412-C	247	M380619-C	245	M3825055-C	249

M382505-C	249	MB470-7	388	MD7025HBN	327	MD948N3	325
M382506-C	249	MB470-9	388	MD7030HBN	327	MD948N4	325
M382507-C	249	MB471-5	388	MD7030HN	327	MD948N5	325
M382508-C	249	MB471-7	388	MD7040HBN	327	MD948N6	325
M382510-C	249	MB471-9	388	MD7050HBN	327	MD948N8	325
M382512-C	249	MB472-5	389	MD7060HBN	327	MD949N	325
M382704-C	251	MB472-7	389	MD7080HBN	327	MD950N	325
M382705-C	251	MB472-9	389	MD801N	328	MD952N	325
M382706-C	251	MB473-5	389	MD802N	328	MD952N1	325
M382708-C	251	MB473-7	389	MD803N	328	MD953N	325
M382709-C	251	MB473-9	389	MD901	328	MD954N	325
M382710-C	251	MB481-10	382	MD9053N	330	MD960N	325
M386510-C	252	MB481-10Q	383	MD906N	331	MD961N	325
M386511-C	252	MB481-10T	382	MD906N1	332	MD961N1	325
M386512-C	252	MB481-10TQ	383	MD906N3	332	MD961N2	325
M386513-C	252	MB481-7	382	MD906N4	332	MD962N	325
M386514-C	252	MB481-7T	382	MD906N5	331	MD962N1	325
M386515-C	252	MB482-10Q	382	MD906TN	326	MD962N2	325
M386516-C	252	MB482-10TQ	383	MD907FL	352	MD962N3	325
M386517-C	252	MB482-7Q	382	MD907TN	326	MD962N4	325
M386518-C	252	MB489-7	379	MD908N	353	MD962N4A	325
M386519-C	252	MB489-8	379	MD908TN	326	MD962N4C	325
MB410	382	MB499-7T	384	MD909TN	326	MD962N4D	325
MB412	382	MB541-5	379	MD910N	330	MD962N5	325
MB416	382	MB541-6	379	MD910TN	326	MD963N	325
MB441-5	376	MB541-7	379	MD911N	331	MD964N	325
MB441-5T	376	MBE470-5	387	MD912N	333	MDA180	424
MB441-6	376	MBE470-7	387	MD914N	324	MDA-R	424
MB441-6T	376	MBE470-9	387	MD915N	324	MDBH	352
MB442-5	376	MBE471-5	387	MD915N1	324	MDH-L	424
MB442-6	376	MBE471-7	387	MD915TN	326	MDH-S	424
MB442-6T	376	MBE471-9	387	MD916N	324	MDM700	321
MB442-7	376	MBE472-5	388	MD916N1	324	MDM706	321
MB442-7S	376	MBE472-7	388	MD916N2	324	MDM706TX	321
MB442-8	376	MBE472-9	388	MD917N	324	MDM706TXT	322
MB442-8T	376	MBE473-5	388	MD917N1	324	MDM711	320
MB442B-8T	376	MBE473-7	388	MD917N2	324	MDM712	320
MB444-10	377	MBE473-9	388	MD920N	324	MDM713	320
MB444-6	377	MBH14	344	MD920N1	324	MDM714	320
MB444-8	377	MBM441	384	MD920TN	326	MDM715	320
MB444-8T	377	MBM449	384	MD922N	324	MDM716	320
MB445-10	377	MBM461	384	MD923N	324	MDM717	320
MB448-6	379	MBM464	385	MD923N1	324	MDM718	320
MB448-8	379	MBM467	385	MD925TN	326	MDM806	320
MB449-10	379	MBM468	385	MD927TN	326	MDM806T	322
MB449-11	379	MBM469	385	MD928N	324	MDM807	320
MB449-9	379	MBV441-6	400	MD928N1	324	MDM807T	322
MB451-7	380	MBV442-8	400	MD928N2	324	MDM808	320
MB451-8	380	MBV451-7	401	MD928N3	324	MDM808T	322
MB452-6	380	MBV451-8	401	MD928N4	324	MDM809	320
MB452-6T	380	MBV461-8	401	MD928N5	324	MDM809T	322
MB452-7	380	MBV499-7	401	MD928N6	324	MDM810	320
MB452-7T	380	MD193	352	MD928N7	324	MDM810T	322
MB452-8	380	MD216	352	MD930N	324	MDM815	320
MB452-8T	380	MD503N	425	MD930TN	326	MDM815T	322
MB452-9	380	MD503NA	425	MD931N	324	MDMC702N	323
MB461-5	380	MD503ND	425	MD932N	324	MDMC715N	322
MB461-6	380	MD503RK	425	MD932N1	324	MDMC718N	322
MB461-6T	380	MD514L	233	MD934N	324	MDN505	329
MB461-8	380	MD514N	233	MD935N	324	MDN5055	329
MB461-8T	380	MD610TPN	326	MD940N	325	MDN506	329
MB463-5	381	MD615TPN	326	MD940N1	325	MDN507	329
MB463-6	381	MD620TPN	326	MD940TN	326	MDN508	329
MB463-8	381	MD625TPN	326	MD945TN	326	MDN510	329
MB463-8T	381	MD627TPN	326	MD947N	325	MDN511	329
MB464-6	381	MD630TPN	326	MD947N1	325	MDN512	329
MB464-6T	381	MD640TPN	326	MD948N	325	MDN513	329
MB465-6	381	MD7020HBN	327	MD948N1	325	MDNT405	329
MB470-5	388	MD7020HNN	327	MD948N2	325	MDNT4055	329

MDNT406	329	MP91500	287	P92320	263	P-SG03	464
MDNT407	329	MP91500RK	287	P92325	263	PT3810R	233
MDNT408	329	MPSL01	286	PB12	442	P-TF01	479
MDNT409	329	MPSL02	286	PB12A	442	P-UKF	411
MDNT410	329	MR500	329	PB16	442	P-UMB16	478
MDNT411	329	MT03	421	PB18A	442	PWC12	383
MDNT412	329	MT03MM	421	PB20	442	PWC14	383
MDNT413	329	MT05	421	PB22A	442	PWC18	383
MDNT414	329	MT05MM	421	P-BCHR	479	PWC24	383
MDP125	425	MT08	421	P-BM	477	PWC36	383
MDP35	425	MT08MM	421	P-BP2	477	P-WSB14	480
MDP90	424	MT10	421	P-BT	479	PZ2500103	338
MDQ147	352	MT15	421	P-CAP7	478	PZ2500110	338
MDQ183	352	MV3800	402	P-CAP8	478	PZ2500203	338
MDQ217	353	MV380020	402	P-CB	477	PZ2500210	338
MDR908	353	MV380021	402	PCCAP	460	PZ2500303	338
MDR908S	353	MV380506	403	P-COA10	480	PZ2500310	338
MDR915	353	MV380507	403	P-COP02	480	PZ5000103	338
MDRQ908	354	MV380508	403	P-CS	480	PZ5000203	338
MDRT908	354	MV380509	403	P-CUPBG	480	PZ5000303	338
MD-SCR	424	MV380510	403	PCX05	461	PZ7000102	338
MDT932N	328	MV380511	403	P-EZP	477	PZ7000202	338
MDT934N	328	MV380512	403	PF380	442	PZ8900101	338
MDT935N	328	MV380513	403	PGW1719	313	PZ8900201	338
MDT952N	328	MV380514	403	PGW1922	313	PZP3000101	339
MDT953N	328	MV380515	403	PGW1924	313	PZP3000105	339
MDTHQ	352	MV380516	403	PGW2124	313	PZP3000201	339
MDV700	398	MV380517	403	PGW2430	313	PZP3000205	339
MDV710	398	MV380518	403	PGW2730	313	PZP3000301	339
MDV724N	396	MV380519	403	PH2500103	337	PZP3000305	339
MDV726N	396	MV380520	403	PH2500110	337	PZP5000101	339
MDV731	399	MX04	236	PH2500203	337	PZP5000201	339
MDV732	399	NS02	440	PH2500210	337	PZP5000301	339
MDV733	399	NS02RKL	440	PH2500303	337	PZP8900201	339
MDV734	399	NS02RKS	440	PH2500310	337	PZZ0102	328
MDV742N	397	NS45108M	343	PH5000103	337	PZZ32000305	338
MDV744N	397	NS45506M	343	PH5000203	337	PZZ32010205	338
MDV751	399	NS45507M	343	PH5000303	337	QC114	344
MDV752	399	NS45508M	343	PH7000102	337	RHA14	230
MDV762N	397	NS45508R	343	PH7000202	337	RHA14	346
MDV764N	397	NSP65108	344	PH8900101	337	ROB2500103	343
MDV771	399	NSP65507	344	PH8900201	337	ROB2500203	343
MDV772	399	NSP65508	344	PHF0365	328	ROB2500303	343
MDV802N	398	NSP65510	344	PHH0102	328	ROBP3000101	343
MDV820N	396	NSP65513	344	PHH32000305	336	ROBP3000105	343
MDV822N	396	O9100115	263	PHH32010205	336	ROBP3000201	343
MDV823N	396	O910075	263	P-HN11	478	ROBP3000205	343
MDV824N	396	O92194	263	PHP3000101	337	ROBP5000101	343
MDV826N	396	O92244	263	PHP3000105	337	ROBP5000201	343
MDV828N	396	O92416	263	PHP3000201	337	ROBP5000301	343
MDV840N	397	O92419	263	PHP3000205	337	ROBP8900101	343
MDV842N	397	O93530	263	PHP3000301	337	ROBP8900201	343
MDV844N	397	O93546	263	PHP3000305	337	ROBP8900301	343
MDV844NF	398	O93548	263	PHP5000101	337	SC01	46
MDV846N	397	O95034	263	PHP5000201	337	SC02	46
MDV860N	397	O95036	263	PHP5000301	337	SC03	47
MDV862N	397	O95046	263	PHP8900201	337	SC04	47
MDV864N	397	O95775	263	PLAC	479	SC04E	48
MDV864NF	398	O97043	263	P-LB	478	SCE1	114
MDV866N	397	O97045	263	PM14	230	SCE2	114
MDV906N	399	O97051	263	PP03	460	SCP01	460
MDV9855	444	P90433	263	PP04	460	SCPS01	55
MH75	456	P90435	263	PP05	460	SCPS01E	55
MH90	456	P90445	263	PP06	460	SCR01	450
MIR25	418	P90543	263	PP07	460	SCR02	450
MPI400	286	P90545	263	PP08	460	SD501	451
MPI400RK-1	287	P90551	263	PPS06	461	SE05	440
MP2700	286	P906110	263	P-SG01	464	SE141	439
MP2700RK-1	287	P90675	263	P-SG02	464	SE142	439



SE143	439	ST12324	441	TBSKT14	247	TCF01	184
SEL01S	439	ST12325	441	TBSKT17	247	TCF02	184
SEL02S	439	ST12506-C	441	TBSKT19	247	TCF03	184
SEL03S	439	ST12506RK-1	441	TBUSP14	427	TCF04	184
SEL04S	439	ST12508-C	441	TBUSP16	427	TC-FB01	194
SEL05S	439	ST12508RK-1	441	TBUSP21	427	TC-FB02	194
SG713	463	ST12510-C	441	TBW10	248	TC-FB03	194
SG713G	464	ST12510RK-1	441	TC103NF	181	TC-H01	194
SG960	462	ST12512-C	441	TC144D	155	TC-H02	194
SG960A	463	ST12512RK-1	441	TC144E	156	TC-H03	194
SG960G	463	ST200	419	TC-160UR	194	TC-H04	194
SG960Y	463	ST38112	441	TC-180CLOCK	190	TC-H05	194
SL01	433	ST38116	441	TC183NF	112	TC-LBK	194
SL02	433	ST38122	441	TC187	155	TC-LEG	194
SL03	433	ST38306	441	TC205NF	169	TC-LOCK3	190
SLM0300	422	ST38308	441	TC-4	181	TC-LOCK5	190
SLM0400	422	ST38310	441	TC450	182	TC-MAG	187
SLM0600	422	ST38311	441	TC-45BL	181	TC-MAT	183
SLM1000	422	ST38312	441	TC540	182	TCMM1001BK	21
SLMI200	422	ST38313	441	TC-540W	182	TCMM1001N	19
SLP2180	386	ST38314	441	TC-6T	181	TCMM1001P	21
SLP3160	386	ST38316	441	TC-6T01	48	TCMM1004N-BK1	41
SLP3180	386	ST38317	441	TC-6T02	49	TCMM1034N	17
SLT01	422	STM1150	419	TC-6TE01	115	TCMM1055N	23
SLT02	422	TI220AF	214	TC-6TE02	115	TCMM277EV	39
SP11	436	TI221	215	TC803N	170	TCMM479	29
SP1410	437	TI221-6	215	TC803NBK	171	TCMM491N	38
SP1410Q	437	TI234	216	TC803SV	171	TCMMS45N	43
SP1810	437	TI244	216	TC805NFX	168	TCMMS46N	37
SP1810Q	437	TI268	217	TC805SV	169	TCMMS569EV	31
SP22	436	TI272	221	TC806NBK	167	TCMM600	27
SP2215	437	TI408	201	TC806NF	167	TCMM622N	33
SP2215Q	437	TI419	201	TC806NFR	167	TCMM715N	25
SP2615	437	TI419	349	TC806NGM	167	TCMME09AQ	102
SP2615Q	437	TI420	202	TC806SV	168	TCMME09BQ	113
SP31410	437	TI420	350	TC810N	170	TCMME09CQ	109
SP31410Q	437	TI422	202	TC8140NF	44	TCMME11A	108
SP31810	437	TI423	202	TC8140P	45	TCMME174	111
SP31810Q	437	TI424	202	TC816STACK	164	TCMME179	110
SP32215	437	TI424S	203	TC816SV	165	TCMME846N	101
SP32215Q	437	TI435AF	203	TC819BK	164	TCMMIND08	35
SP32615	437	TI436	204	TC819NBK	164	TCMONSTER02	15
SP32615Q	437	TI460	204	TC820SV	44	TCNBC	188
SP3320	437	T3418-6	220	TC-90CLOCK	190	TCP445C	182
SP3320Q	437	T3834	206	TCA01	186	TC-PA01	194
SP33320	437	T3834S	207	TCA05	184	TC-PA02	194
SP33320Q	437	T3835AF	207	TCA06	454	TC-PA03	194
SPA11	436	T3839	208	TCA06RK	454	TC-PA03	194
SPA22	436	T3840	208	TCA07	454	TC-PRK	190
SPBP20	426	T3848	209	TCATV	186	TCRFH	188
SQAA200	420	T3867	209	TCAV4	186	TC-S01	192
SQAA250	420	T9206	224	TCB135	194	TC-S02	192
SQAA300	420	T9218AF	225	TCB180	194	TC-S03	196
SQAB10070	420	T9218LAF	225	TCB80	193	TC-S03AL	193
SQAB150100	420	T9222	224	TCB80A	193	TC-S03AR	193
SQAB200130	420	T9222L	224	TCB-KEYE	190	TC-S04	196
SQAB300175	420	T9240	225	TCC01	195	TCSB	182
SQAC300	420	T9417	225	TCC02	195	TCSB16	183
SR1160	407	T9417L	226	TCC03	195	TC-SC	181
SR1180	407	T9421LAF	226	TC-COVER	183	TC-SL01	192
SR2180	407	T9423AF	226	TC-COVER1	183	TC-SL02	192
SR3160	407	TAP-HNDL	413	TCDIVL	184	TC-SL03AL	193
SSH01	461	TBBSI27	351	TCDIVS	184	TC-SL03AR	193
SSH02	462	TBNSI5	351	TCDRK	190	TCSMC	189
SSH03	462	TBSKT07	247	TCDSH	188	TCT01	195
SSH04	462	TBSKT08	247	TCEMM1117N	99	TCT02	195
ST12319	441	TBSKT10	247	TCEMM249N	104	TCT03	195
ST12321	441	TBSKT12	247	TCEMM417N	103	TCT04	195
ST12322	441	TBSKT13	247	TCEMM631N	107	TC-TB01	187

TC-TB02	187	TEAVSD09	147	TFAI2	446	TPT01	196
TC-TB03	187	TED00	118	TFAI5	446	TPX2501003	341
TCTMC	189	TED01	118	TFA22	446	TPX2501503	341
TC-UPRL	194	TED1227	124	TFP01	445	TPX2502003	341
TC-UPRLS	194	TEDI489	123	TFP01RK	446	TPX2502503	341
TC-UPRR	194	TED3836	123	TFP02	446	TPX2502703	341
TC-UPRRS	194	TED441-T	143	TFP02RK	446	TPX2503003	341
TCW207N	177	TED6512R	134	TGMMUNC	419	TPX2504003	341
TCW208NBK1	177	TED6512RS	134	THBS22	347	TQAG	286
TCW707EV	174	TED6515	132	THBSI22	347	TQS018	287
TCW803N	172	TED8012	132	T-HD	237	TQS042	287
TCW804N	172	TED909TXN	137	T-HD01	247	TQS055	287
TCW806LN	178	TED911N	137	T-HD01	427	TQS065	287
TCW806N	173	TED9121	129	THDV105	154	TR070	191
TCW806N1	173	TEDAD34	135	THDV105E	154	TRC1012	427
TCW807N	174	TEDDF7	135	TJ028	348	TRC1418	427
TCW808N	175	TEDHEX7	141	TJ1412	348	TT00	52
TCW809N	178	TEDHT42	142	TJ1413	349	TT01	52
TCW810N	175	TEDIMM	150	TJ1414	349	TT02	52
TCW810NBK	176	TEDPC14	151	TJ1415	200	TT03	52
TCW814N	179	TEDSD14	131	TJ1419	200	TT04	52
TCW816LN-STACK	166	TEDTX7	141	TJ1420	201	TT1205	58
TCW819STACK	166	TEDV3818	148	TJ1429	348	TT1211	58
TCW907X	176	TEDV440	147	TJ1430	348	TT1215AF	60
TC-WC02	183	TEDV909N	147	TJ149	425	TT1217	59
TCW-CAB	180	TEFMB7	119	TJNS05	349	TT1217-6	59
TCW-CAB01	180	TEFMBP7	119	TJSE05S	414,439	TT1218	59
TCW-CAB02	180	TEFMBP7E	119	TM010	350	TT1218-6	59
TCW-CAB03	180	TEFMD54	139	TM029	350	TT1236	68
TCW-HK02	187,195	TEFMDI54	140	TM035NF	156	TT1435	55
TCW-HK10	187,195	TEFMDV12	148	TM080	210	TT143512	56
TCW-HK45	187,195	TEFSK44	124	TM095	222	TT1448	56
TCW-HK90	187,195	TEFSK57	126	TM106	222	TT3592	68
TCW-HKAIR	187,195	TEFX06	119	TM111	223	TT3816	57
TCW1Q-SC	188	TEFX06E	120	TM127	223	TT381612	57
TCW-SP	186	TEFX07	120	TM708	321	TT3819	57
TCW-SP01	186	TEFX07A	120	TMC010	351	TT381912	57
TCW-SW	188	TEFXV11	148	TMTX10	350	TT440	81
TDD03050	414	TEFXV27	149	TORP01A	289	TT440-T	82
TDD04070	414	TEFXV28	149	TORP01E	289	TT474-5	83
TDD05080	414	TEX02	118	TORP01U	289	TT474-5E	83
TDD06100	414	TEX1238	132	TORP01U	289	TT474-7	83
TDD08125	414	TEX2032	133	TORQU	289	TT474-7E	83
TDD10150	414	TEX3403	125	TORQ02	288	TT6010M	68
TDD12175	414	TEX3410	126	TORQ02A	288	TT6010MRS	70
TDTO3050	413	TEX6308	135	TORQ02U	288	TT6208	72
TDTO4070	413	TEX915N	137	TORQ02U	288	TT6506	72
TDTO5080	413	TEXEXT13	125	TORQ03	288	TT6508R	69
TDTO6100	413	TEXFLS06	135	TORQ03A	288	TT6508RAF	70
TDTO8125	413	TEXMB02	143	TORQ03U	288	TT6508RF	70
TDTI0150	413	TEXMDTN	140	TORQ03U	288	TT6508RS	71
TDTI2175	413	TEXMPI2	132	TORQ04	288	TT6511R	70
TEA01	118	TEXPB4	151	TORQ04A	288	TT6511RS	71
TEA02	118	TEXTB05	150	TORQ04U	288	TT8012	68
TEA1487	122	TEXW05	150	TORQ04U	288	TT804	91
TEA7203	123	TEZ01	118	TORQ05	288	TT9015HX	65
TEA9214LAF	129	TEZMD06	136	TORQ05A	288	TT9024	63
TEA9216AF	129	TEZSD02	131	TORQ05U	288	TT9116N	64
TEABS50	140	TEZSN06	151	TORQ05U	288	TT9120DN	64
TEAHR81	151	TEZVGO3	146	TORQ99A	288	TT917N	74
TEAMD04N	136	TF22	445	TORQ99E	288	TT917TXN	75
TEAMD04N1	136	TF2230RK	445	TORQ99U	288	TT9207	63
TEAMD04TXN	136	TF30	445	TORQ99U	288	TT9207A	64
TEAMDQ78	141	TF300	446	TORQA	289	TT9212	64
TEAMDV04N	146	TF300RK	446	TORQS01	289	TT9212TX	65
TEAMDV04N1	146	TF76	445	TORQU	289	TTADJ04	73
TEAMDV10	146	TF76RK	445	TORQU	289	TTADP17	63
TEASD38	131	TFA0252RK	446	TPM01	197	TTAF32	56
		TFAI0	446	TPM02	197	TTAF3212	56

TTALU	52	TTMI16	76	TTXFLS06	72	TXP3002705	340
TTBE18	92	TTNF12	88	TTXLMPI2	69	TXP3003001	340
TTBM	89	TTNF12-01	415	TTXMB02	82	TXP3003005	340
TTBS35	58	TTNF12-02	415	TTXMD41N	79	TXP3004001	340
TTBSS3	80	TTNF12-03	415	TTXMDTN	75	TXP3004005	340
TTCP04	93	TTNF12-04	415	TTXMP12	67	TXP5001001	340
TTCP121	93	TTNF12-05	415	TTXND	76	TXP5001501	340
TTD00	53	TTNF12-06	415	TTXPI292	67	TXP5002001	340
TTD01	53	TTNF12-07	415	TTXPB3	92	TXP5002501	340
TTD02	53	TTNF12-08	415	TTXPB3A	92	TXP5002701	340
TTD441	82	TTNF12-09	415	TTXQRS07	73	TXP5003001	340
TTD441-T	82	TTNF12-10	415	TTXTB05	90	TXP5004001	340
TTD912TXN	75	TTNF12-11	415	TTXTB09	91	TXP8902001	340
TTD914N	74	TTNF12-12	415	TTZ01	54	TXP8902501	340
TTD9416	65	TTNR81	94	TTZVG03	84	TXP8903001	340
TTDAWM13M	95	TTOS16	90	TT18N	402	TXX1015	328
TTDB28	87	TTPC09	95	TW1160	386	TXX2025	328
TTDCM	89	TTPS09	54	TW1180	386	TXX3040	328
TTDCT05	87	TTPS09E	54	TW2125	386	TXX32101505	339
TTDTD34	88	TTPSAD	91,434	TW2160	386	TXX32202505	339
TTDV910N	85	TTSPSG	85	TW2180	386	WR8012	157,299
TTEAF62	133	TTRORS	73	TWB1500	191	WRDF06	158,311
TTEISK33	130	TTRS15	61	TWB-1500A	191	WRFL05	161
TTEISK73	130	TTSD38	66	TWB-15SQ	191	WRFLS05	158,307
TTMB11	143	TTSN11	92	TWB-1STOP	191	WRHEX07	159,362
TTMB13Q	144	TTSR04	89	TWB2000	191	WRHEX07AF	159,362
TTMB14Q	145	TTSS07	90	TWB-2000A	191	WRMB04	160
TTMB17	144	TTTC06	93	TWB-20SQ	194	WRMBV04	160,401
TTMD122N	138	TTTD17	87	TWB-20TOP	191	WRMD10N	158
TTMD33	139	TTTTF10	91	TWB-4WD	191	WRMDT05N	159,329
TTMD98N	138	TTTHQ62	77	TWB-FB	194	WRMDV05N	160
TTEPS12	121	TTTJ04	53	TWB-LEG	191	WRMDV07N	160
TTEPS15	121	TTTM03	94	TWB-PA	191	WRPC10	161,461
TTEPS25	120	TTTM08	95	TWB-UPR	191	WRSP12	157,293
TTESK126	127	TTTS08	65	TX2500603	339	WRSP12LMP	157,301
TTESK32	126	TTTX18	60	TX2500703	339	WRSP12RS	157,304
TTESK63	125	TTTX23	61	TX2500803	339	WRTX07	159,371
TTESK77	128	TTTX30	58	TX2500903	339		
TTESK85	128	TTTX7	81	TX2501003	339		
TTESK86	127	TTTXH15	61	TX2501503	339		
TTESP28	121	TTV3814	86	TX2502003	339		
TTESP31	133	TTV440	86	TX2502503	339		
TTESP37	134	TTV706N	85	TX2502703	339		
TTEVG11	145	TTV710N	86	TX2503003	339		
TTX17	122	TTV907N	85	TX2504003	339		
TTEX23N	142	TTVG05	84	TX5000803	339		
TTEX32	134	TTVSD09	86	TX5001003	339		
TTXC03	90	TTX00	53	TX5001503	339		
TTHEX16	60	TTX01	53	TX5002003	339		
TTHEX23	60	TTX02	54	TX5002503	339		
TTHEX7	80	TTX03	54	TX5002703	339		
TTHEX7AF	81	TTX1292	67	TX5003003	339		
TTHEX7S	80	TTX2032	69	TX7001002	340		
TTHP08	73	TTX2640	69	TX7001502	340		
TTHR81	94	TTX3402E	62	TX7002002	340		
TTHT28	81	TTX3404	62	TX7002502	340		
TTID19	66	TTX3404S	62	TX8901001	340		
TTID20	66	TTX3414	62	TX8902001	340		
TTK40	87	TTX34AF	63	TX8902501	340		
TTMD12D	75	TTX3892	67	TX8903001	340		
TTMD74	78	TTX474-9	84	TXP3001001	340		
TTMD74-1	345	TTX474-9E	84	TXP3001005	340		
TTMD74-2	345	TTX6311	71	TXP3001501	340		
TTMDP	89	TTX6607	72	TXP3001505	340		
TTMDQ38	78	TTX6707	71	TXP3002001	340		
TTMDQ49	76	TTX918N	74	TXP3002005	340		
TTMDQ76	77	TTX9415	66	TXP3002501	340		
TTMDR84	78	TTXEXT13	61	TXP3002505	340		
TTMDRT64	79	TTXF05	88	TXP3002701	340		



